

RADIO — ELECTRONICS

FEBRUARY 1952

LATEST IN TELEVISION • SERVICING • AUDIO

HUGO GERNSBACK, Editor

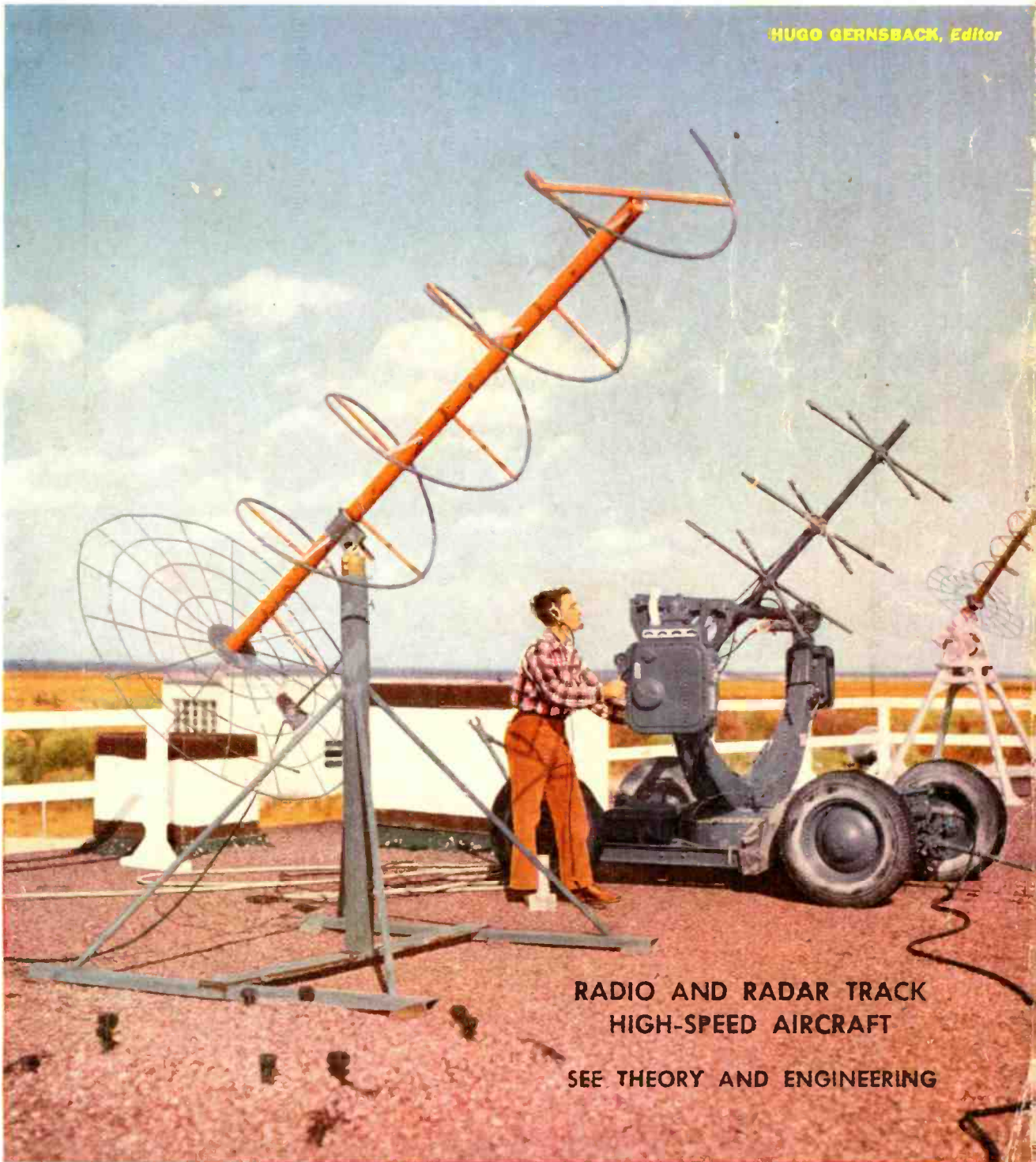

RADIO AND RADAR TRACK
HIGH-SPEED AIRCRAFT

SEE THEORY AND ENGINEERING

30¢
U.S. and
CANADA

In this issue: Ion Burns and Beam Benders •
Direct Reading Freqmeter • Audio Waveform Analysis

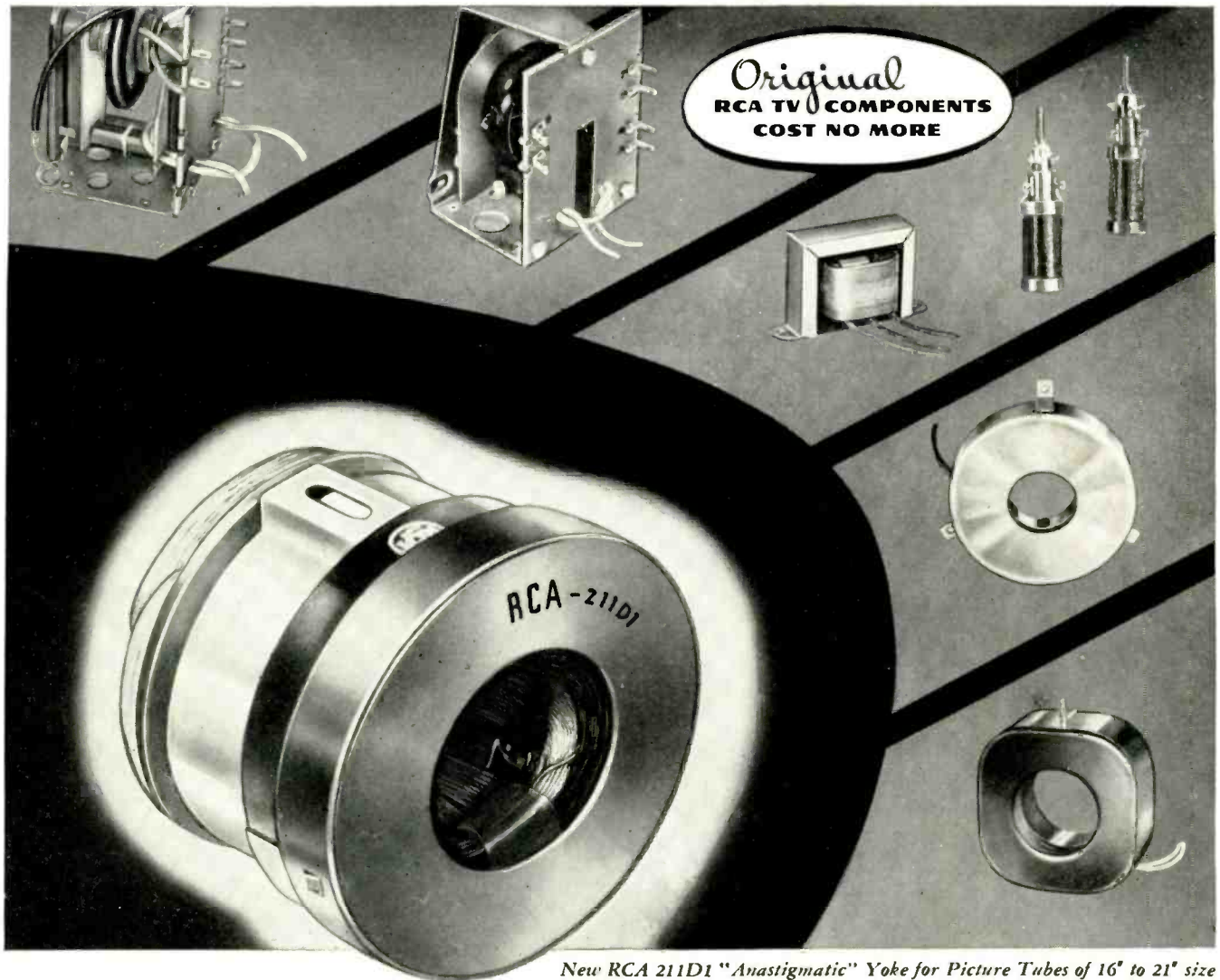

New RCA 211D1 "Anastigmatic" Yoke for Picture Tubes of 16" to 21" size

For best results use the yoke that's tailored to the tube

Check these features . . .

- ✓ Distributed windings of modified "cosine" design for sharp corner focus
- ✓ Negligible pattern distortion
- ✓ Freedom from insulation breakdown
- ✓ Terminals securely mounted
- ✓ Sturdy molded housing

Why take chances with "compromise" yokes when RCA "originals" cost no more?

Remember—RCA deflecting yokes set the engineering standards of the field. That's because RCA deflecting yokes and RCA picture tubes are designed to work as a team. Mechanically and electrically, RCA yokes "fit like a glove" . . . work best with the picture tubes they're specifically designed for.

Always the leader—RCA deflecting yokes were the first to use Ferrite cores . . . first to use distributed windings

providing negligible barrel and pin-cushion distortion. And . . . RCA yokes were the first to be constructed with a molded housing of solid plastic that affords increased insulation between windings and core, insures high resistance to humidity, and holds terminal lugs firmly.

RCA yokes are best fitted to restore original performance in the many makes of TV receivers you service. When a replacement is called for, play safe . . . use the yoke that "fits the tube." *That's RCA!*

See your local RCA Parts Distributor for "Original" RCA TV Components.



RADIO CORPORATION of AMERICA
ELECTRONIC COMPONENTS

HARRISON, N. J.

NEW



I'LL TRAIN YOU FOR YOUR FCC LICENSE

A Federal Communications Commission Commercial Operator's License puts you in line for a good job in Radio or Television Broadcasting. Police, Marine, Aviation, Two-way, Mobile or Micro-wave Relay Radio. Mail coupon below for 64-page book FREE. It will give you complete facts about my NEW Communications course.



YOU BUILD THIS TRANSMITTER

with parts I send. With this Transmitter you practice how to put a station "on the air." You perform procedures demanded of Broadcast Station Operators, conduct many experiments, make many practical tests.

LEARN COMMUNICATIONS by PRACTICING at Home in Spare Time

with MANY KITS of RADIO EQUIPMENT I SEND



MY COURSE INCLUDES TELEVISION

Course Is New! Different!

Mail coupon now for facts about my NEW, intensely practical course in Radio-Television Communications. Let me send you FREE book. Read outlines of 78 lesson texts written by leaders in Communications and edited for you by my practical staff. See the nine big Kits of Parts I send that "bring to life" theory you learn. Read about the Transmitter you build and operate, about the Electronic Multitester you get. All equipment yours to keep. My NEW course covers Theory thoroughly and you get Practical Experience building units like those shown at the left. It's backed by N. R. I.—the world's oldest and largest home study Radio-Television school.



YOU BUILD this Transmitter Power Supply used in the basic experiments in RF and AF amplifiers, frequency multipliers, buffers, etc.

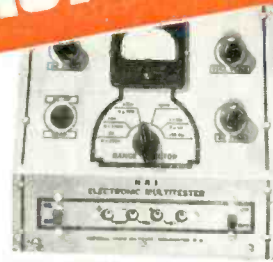

YOU MEASURE current, voltage (AC, DC and RF), resistance and impedance in circuits with Electronic Multitester you build. Shows how basic transmitter circuits behave; needed to maintain station operation.



YOU PRACTICE setting up code, amplitude and frequency modulation circuits (put voice, music, etc., on "carrier signals" you produce). You learn how to get best performance.



YOU BUILD this Wavemeter and use it to determine frequency of operation, make other tests on transmitter currents.

Ever think HOW FAST Radio-Television Communications is changing, developing, growing? Have you considered what this amazing progress can mean to you?

Look at these facts. In 1946 only 6,000 Television sets were sold. In 1950, over 5,000,000. By 1954, 25,000,000 Television sets will be in use, according to estimates. 100 Television Stations are operating in 35 states. Authorities predict there will be over 1,000 Television Stations. This rapid growth means new jobs, more jobs, good pay for qualified men all over the U. S. and Canada. Then add development of FM, Two-way Radio, Police, Marine, Aviation and Micro-wave Relay Radio! Think what all this means! New jobs, more jobs for beginners! Better jobs, better pay for experienced men!

Are you a beginner who wants steady work in this growing field? My NEW course can help you get an FCC License and prepare for the job you want. Are you a man with some training in Radio or Radar, or a Licensed Operator? My NEW course modernizes, increases the value of your knowledge and experience!

Servicing Training Also Offered by N. R. I.

If you prefer a good-pay job in Radio-Television Servicing or your own money-making Radio-Television Sales and Service Shop, I'll train you at home. My famous Servicing Course also includes many Kits of Radio Parts. You use them to get PRACTICAL EXPERIENCE with circuits common to Radio and Television. I also show you how to make \$5, \$10 a week or more EXTRA MONEY fixing neighbors' Radios while training. Full information in my 64-page book. Mail coupon.*

Mail Coupon For Book FREE

Send today! See what my NEW course is like. Find out how I get you ready for a brighter future, better earnings, more security in Radio-Television. Send coupon now in envelope or paste on a postal. NO OBLIGATION. NO SALESMAN WILL CALL! My book, sent to you FREE, tells the full story. J. E. SMITH, President, Dept. 2BF, National Radio Institute, Washington 9, D. C.

EXTRA PAY IN ARMY, NAVY, AIR FORCE

Knowing Radio, TV, Electronics can help you get extra rank, extra prestige, more interesting duty at pay up to several times a private's base pay. You are also prepared for good Radio-TV jobs upon leaving service. Mail Coupon TODAY.

I TRAINED THESE MEN



"N.R.I. has been my stepping stone from a few hundred to over \$4,000 a year as a Radio Engineer."—ALTON B. MICHAELS, Trenton, Georgia.



"I am employed by WKBO as transmitter operator. Have more than doubled salary since starting in Radio full time!"—A. HERR, New Cumberland, Penna.



"Am Broadcast Engineer at WLFM. Your NEW Communications course shows the kind of equipment we use."—J. BANGLEY, JR., Suffolk, Virginia.



"4 years ago, I was a book-keeper with hand-to-mouth salary. Am now Radio Engineer with ABC network."—N. H. WARD, Ridgefield Park, N. J.

MAIL NOW-BOOK FREE

MR. J. E. SMITH, President, Dept. 2BF, National Radio Institute, Washington 9, D. C.

Mail me your 64-page Book about Radio and Television Communications opportunities and training. (No salesman will call. Please write plainly.)

Name _____ Age _____

Address _____

City _____ Zone _____ State _____

Approved Under G. I. Bill

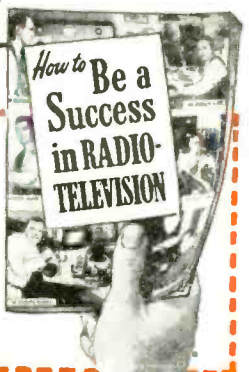

RADIO - ELECTRONICS

Formerly RADIO-CRAFT • Incorporating SHORT WAVE CRAFT • TELEVISION NEWS • RADIO & TELEVISION*

Hugo Gernsback,
Editor-in-Chief

M. Harvey Gernsback
Editorial Director

Fred Shunaman
Managing Editor

Robert F. Scott
W2PWG, Technical Editor

I. Queen
Editorial Associate

Angie Pascale
Production Manager

Wm. Lyon McLaughlin
Tech. Illustration Director

Lee Robinson
General Manager

John J. Lamson
Sales Manager

G. Aliquo
Circulation Manager

Robert Fallath
Promotion Manager

CONTENTS

FEBRUARY 1952

Editorial (Page 21)			
Television Servicing	by Hugo Gernsback	21	
Servicing—Test Instruments (Pages 22-36)			
When is the Technician Liable?	by Leo T. Parker	22	
Frequency Meter	by Henry O. Maxwell	25	
Wheelchair Service Shop	by J. T. Cookson	28	
An Antenna Story		29	
Service Bench Contest—First Prize Winner		30	
Practical Codan Circuits	by Ronald L. Ives	32	
Ion Burns	by Robert F. Scott	34	
Television (Pages 37-43)			
TV Ghost Story	by H. E. Warriner	37	
TV DX for February		39	
TV I.F. Interference	by William L. Kiser	40	
Television Service Clinic	by Matthew Mandl	42	
Audio (Pages 44-50)			
Constant Voltage Lines	by N. H. Crowhurst	44	
Audio Waveform Analysis	by John D. Ledbetter	46	
Electronics & Music, Part XX	by Richard H. Dorf	49	
FM (Page 51)			
FM Wins in British Tests	by Ralph W. Hallows	51	
Broadcasting & Communications (Pages 52-54)			
Operating TV Studio Equipment, Part I	by Harold Ennes	52	
Electronics (Pages 55-59)			
Algebra in Electronics Design	by Edmund C. Berkeley	55	
Electronic Flame Control	by Thomas L. Bartholomew	58	
Theory and Engineering (Pages 60-62)			
Radio and Radar Aid Air Research (Cover Story)		60	
Wide-Band Chain Amplifier	by Robert L. Gish	62	
Amateur (Pages 66-73)			
Beginner's V.F. Oscillator	by Gilbert L. Countryman	66	
Construction (Pages 78-92)			
I-Tube Loudspeaker Radio	by H. W. Secor	78	
A Communications Receiver for Hams	by T. W. Dresser	86	
Departments			
The Radio Month	10	Circuits	104
Radio Business ..	14	With the	
New Devices ...	76	Technician ...	107
New Patents ...	101	Try This One ...	108
Radio-Electronic		Question Box ...	110
		Miscellany	113
		Technotes	118
		People	120
		Communications ..	122
		Book Reviews ...	126

ON THE COVER:

These special-design radio antennas on the roof of the Wallop's Island control building are used to receive data teleme-tered from rocket-launched re-search models. (Color photo-graph courtesy N.A.C.A.)



MEMBER Audit Bureau of Circulations

RADIO-ELECTRONICS Published monthly by Radcraft Publications, Inc., at Erie Ave., F to G Streets, Philadelphia 32, Pa. Vol. XXIII, No. 5

EXECUTIVE, EDITORIAL and ADVERTISING OFFICES: 25 West Broadway, New York 7, N. Y. Telephone REctor 2-8630. Hugo Gernsback, President; M. Harvey Gernsback, Vice-President; G. Aliquo, Secretary.

SUBSCRIPTIONS: Address correspondence to Radio-Electronics, Subscription Dept., Erie Avenue, F to G Sts., Philadelphia 32, Pa., or 25 West Broadway, New York 7, N. Y. When ordering a change please furnish an address stencil impression from a recent wrapper. Allow one month for change of address.

SUBSCRIPTION RATES: In U. S. and Canada, in U. S. possessions, Mexico, South and Central American countries, \$3.50 for one year, \$6.00 for two years; \$8.00 for three years. Single copies 30c. All other foreign countries \$4.50 a year, \$8.00 for two years; \$11.00 for three years. Entered as second class matter September 27, 1948 at the post office at Philadelphia, Pa., under the Act of March 3, 1879. Copyright 1952 by Radcraft Publications, Inc. Text and illustrations must not be reproduced without permission of copyright owners.

BRANCH ADVERTISING OFFICES: Chicago: 100 E. Ohio St., Telephone Superior 7-1798. Los Angeles: Ralph W. Harker, 1127 Wilshire Blvd., Tel. MA 6-1271. San Francisco: Ralph W. Harker, 582 Market St., Tel. GARfield 1-2481. FOREIGN AGENTS: Great Britain: Atlas Publishing and Distributing Co., Ltd., London E.C.4. Australia: McGill's Agency, Melbourne. France: Brentano's, Paris 2e. Holland: Trifectron, Heemstede. Greece: International Book & News Agency, Athens. So. Africa: Central News Agency, Ltd., Johannesburg. Capetown; Durban. Natal. Universal Book Agency, Johannesburg. Middle East: Steimatzy Middle East Agency, Jerusalem. India: Broadway News Centre, Dadar, Bombay 214. K. L. Kannappa Mudaliar, Madras 2. Pakistan: Paradise Book Stall, Karachi 3.

POSTMASTER: If undeliverable send form 3578 to: RADIO-ELECTRONICS, 25 West Broadway, New York 7, N. Y. *Trademark registered U.S. Patent Office.

TRAIN for Security! Good-Paying Jobs! MAKE THE MONEY YOU'VE ALWAYS DREAMED OF!



LEARN RADIO -TELEVISION

AND ELECTRONICS BY EASY SHOP METHOD TRAINING AT HOME!

You get all the parts—even tubes!—
for this modern Superheterodyne Receiver. You learn to build it step by step. And you keep it! Get all the facts. Mail coupon now.

Let **NATIONAL SCHOOLS**—a resident-training school for nearly 50 years—train you at home for today's unlimited opportunities in Radio-Television-Electronics. National Schools is one of the largest schools of its kind. It is located in Los Angeles—the center of Radio and TV world! It has four large buildings of modern shops and labs. Its faculty is considered tops in the business.



You learn from lessons prepared by experienced instructors and engineers. Men who are successful Radio and Television technicians. Men who have trained 1000's of men like YOU!



FREE BOOK TELLS YOU HOW!

Page after page—In color—tells you everything you want to know. Mail the coupon. Get this valuable book today. And if you hurry—YOU GET A FREE SAMPLE LESSON, TOO! Shows how easy National Schools Home Training is. Mail the coupon today.

You Train At Home—In Your Spare Time

National Schools Shop Method Home Training gives you basic and advanced instruction in all phases of Radio-TV-Electronics. And remember—your training is based on resident school training principles. You learn *fast* from hundreds of diagrams and pictures. All instructions are written by experienced technicians who work in Radio and TV every day. All instructions have been developed and tested in National Schools' own labs and studios, which are equipped with the latest RCA equipment. No wonder this National Schools course is so up-to-date, practical, interesting. And so easy to learn! And no wonder it is held in such high regard by leaders of American industry! Approved for eligible Veterans.

We Teach You How To Make Welcome Extra Money—While You Learn!

Many National Schools students—men like you—make plenty of extra dollars each week in spare time! Fixing neighbors' radios, appliances—and other ways we teach you. You start learning and earning from the day you enroll. From the very first lesson!

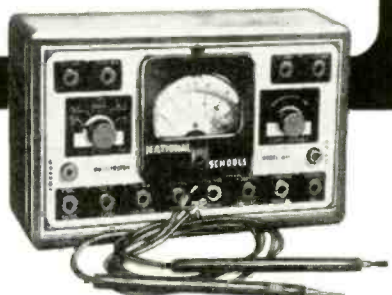

Only National Schools Gives You This Professional Multi-Tester!

You get this amazing, new testing instrument—factory-made and tested—complete—ready to use! Simple to operate. Accurate and dependable. An instrument every Radio-TV man needs. Light enough to carry around—so you can use it at home or on service calls. You'll be proud to own this valuable equipment.

Here are only a Few of the Good-Paying Jobs You Can Choose

Radio Station Engineer, District Service Manager, Aircraft Radio Inspector, Own Your Own Repair Shop, Inspector Technician, Service Specialist, Special Government Jobs, Complete TV Service, Sound Truck Operator. Many more! National Schools graduates have secure, good-paying jobs like these! So don't wait—mail the coupon today. Now—while you're thinking about it!

Today's Shortage of Trained Technicians Creates Chance of a Lifetime For You!

Think of it! With guided missiles, radar, and other electronic devices so important to national defense! With big, new developments in TV. With over 90,000,000 home and auto radios, over 12,000,000 TV sets. With more than 3100 radio stations...over 100 TV stations—and more building every day...yes, imagine the great opportunity you have today! YOU are wanted in Radio-Television-Electronics! America's fastest-growing field. High-pay jobs—the kind you've always wanted—are waiting for YOU!

Job Security! Big Money! For YOU! in Today's Expanding Industries!

Trained Radio and Television technicians really make important money these days. Thousands of National Schools graduates—men just like you—are earning good money all over the country. Why not you? And—National Schools graduates get the personal satisfaction of being highly-skilled technicians. Men people respect. Men who *enjoy* their work—rather than having to drag along in just any old job.

National Schools Has Trained 1000's of Successful Men! Why Not YOU?

In almost every state—and many foreign countries—National Schools graduates are filling big jobs with famous companies. Or running their own successful businesses. What are YOU waiting for? National Schools training is *complete* training. So when you graduate you can take advantage of today's big opportunities in Radio-Television-Electronics—fast.

WE SEND YOU LOTS OF PARTS LIKE THIS!

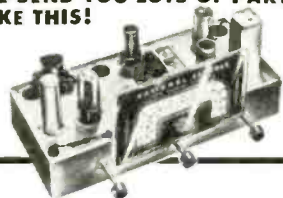

With National Schools Shop Method Home Training, you get basic principles and plenty of *practical* training. You learn *by doing*. No wonder you learn so fast! We send you many parts—all of professional, modern quality. You do lots of practical experiments. You advance day by day, step by step. Until you can even build the modern Superheterodyne Receiver you see above—plus other important testing units. The free book tells you all about it. The free sample lesson shows how easy the training is. Use the coupon. Send today—without fail!

Attention! Men Going into Service Soon!

National Schools' course quickly prepares you for many important jobs in the Armed Services. With National Schools Training you have an opportunity to get into *special* service classifications—with higher pay and grade—immediately!

FREE SERVICE FOR GRADUATES

National Schools uses its great influence and prestige to help you find your place in the field of your choice. Don't put it off! Start yourself toward a skilled trade! Get the big pay you've always wanted!

NATIONAL SCHOOLS

LOS ANGELES 37, CALIFORNIA • ESTABLISHED 1905

**DON'T PUT IT OFF!
GET THE BIG SALARY YOU HAVE ALWAYS WANTED!**

MAIL THIS COUPON TODAY—WITHOUT FAIL!

NATIONAL SCHOOLS, Dept. GR-22
4000 South Figueroa Street
Los Angeles 37, California

Mail in envelope or paste on penny post card.

Mail me FREE the book mentioned in this ad. Also a free sample lesson. I understand no salesman will call on me.

NAME _____ AGE _____

ADDRESS _____

CITY _____ ZONE _____ STATE _____

Check here if you were released from the Service less than 4 years ago.

What's inside a *Radio-Relay* station?

Because microwaves travel in straight lines and the earth is round, there are 123 stations on the transcontinental television route between Boston and Los Angeles. This view of a typical unattended station shows the arrangement of the apparatus which amplifies the signal and sends it on.

ON THE ROOF are the lens antennas, each with its horn tapering into a waveguide which leads down to equipment

ON THE TOP FLOOR, where the signal is amplified, changed to a different carrier-channel and sent back to another antenna on the roof. Here are testing and switching facilities. Normally unattended, the station is visited periodically for maintenance.

ON THE THIRD FLOOR are the plate voltage power supplies for several score electron tubes.

ON THE SECOND FLOOR are filament power supplies. Storage batteries on both floors will operate the station in an emergency for several hours, but

ON THE GROUND FLOOR is an engine-driven generator which starts on anything more than a brief power failure.

Anything that happens—even an opened door—is reported to the nearest attended station instantly.

Coast-to-coast *Radio-Relay* shows again how scientists at Bell Telephone Laboratories help your telephone service to grow steadily in value to you and to the nation.



BELL TELEPHONE LABORATORIES

Improving telephone service for America provides careers for creative men in scientific and technical fields.

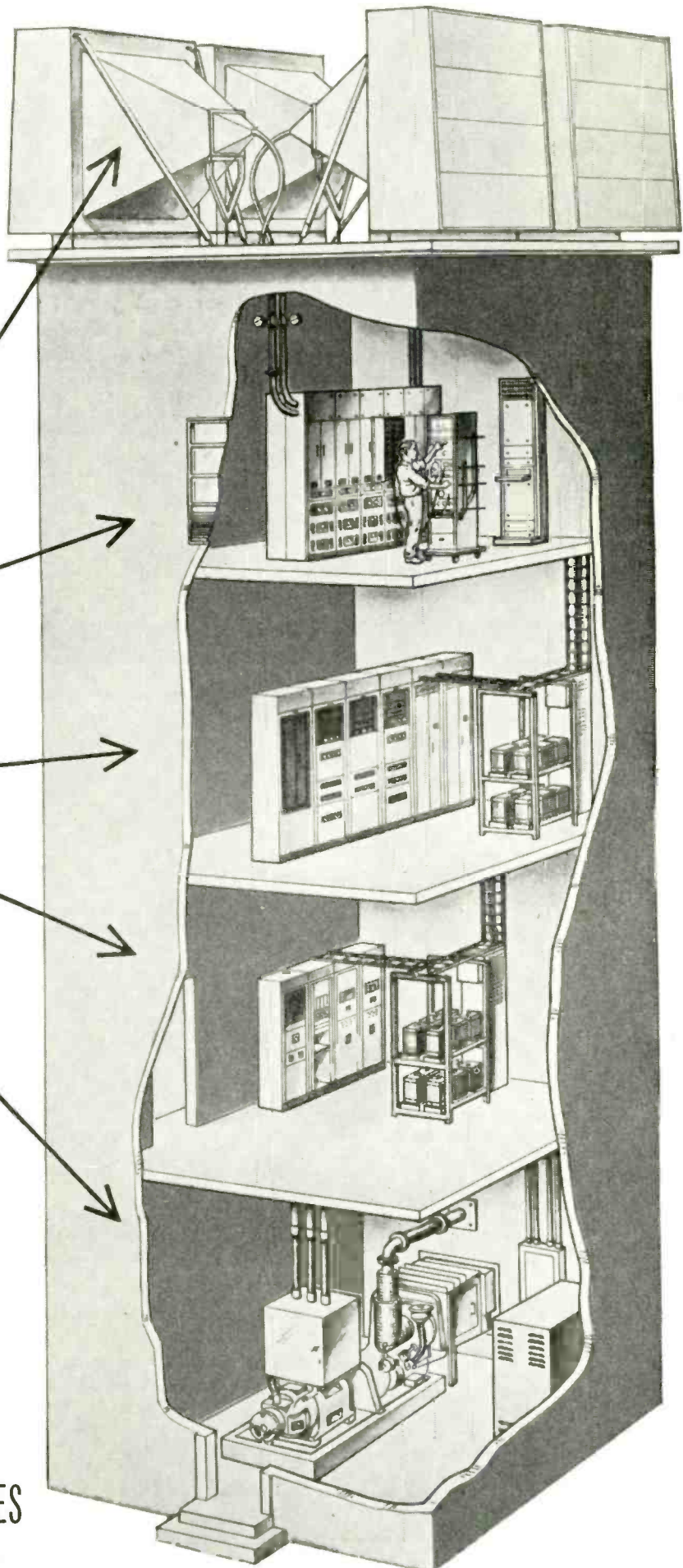

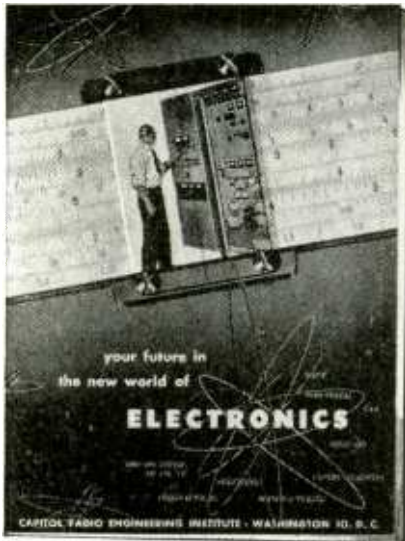

← *The data that Launched Thousands
of Careers is yours FREE . . .
to show*

HOW YOU CAN BE SUCCESSFUL IN RADIO-TV-ELECTRONICS

YOU CAN plod along for years, getting a paltry increase now and then, enjoying little security, finding your work dull and drab.

Then something happens. Things look up. You become more confident. Your earnings rise. You feel more important.

"Luck," some may say.

"Contacts," others may suggest.

But in your heart, you will know the answer: "Training." And it all may have started the moment you filled out a coupon requesting a copy of a free booklet named "Your Future in the New World of Electronics." From this data you get knowledge of where you stand in Electronics. Tremendous expansion leaves this gigantic industry pleading for trained men. In the defense build-up alone, more than \$7 billion in electronics contracts have been awarded. Top manufacturers sold about \$3 billion worth of electronic merchandise in 1951. By 1960, the radio-electronics industry should do no less than 10 billion dollars per year, not counting military orders.

Today there are over 50,000 radio-equipped police cars; an even larger number of taxis are radio equipped (at least 65,000); 28,000 civilian planes have radio; 27,000 American ships have radio; there are 9,200 industrial radio network installations.

Within 5 years, says the Chairman of the FCC, there will be 1,500 TV stations, and in 10 years, 2,500 in operation. There are 11,496,000 TV sets and over 100,000,000 radios in operation. How these figures will increase in the next few years the most daring of experts are reluctant to predict. Countless positions must be filled—in development, research, design, production, testing and inspection, manufacture, broadcasting, telecasting and servicing. To fill these posts, trained men are needed—men who somewhere along the line take time to improve their knowledge, their skills. Men who, today, perhaps, take two minutes to send for a booklet.

"Your Future in the New World of Electronics" shows you how CREI Home Study leads the way to greater earnings through the inviting opportunities described above.

However, CREI does not promise you a "snap." With an accredited technical school such as this, you must *study* to convert your ambition into technical knowledge you can sell in the fabulous Electronics market.

Since its founding in 1927, CREI has provided thousands of professional radio men with technical educations. During World War II CREI trained thousands for the Armed Services. Leading firms choose CREI courses for group training in electronics at company expense, among them United Air Lines, Canadian Broadcasting Corporation, Trans Canada Airlines, Sears, Roebuck and Co., Bendix Products Division, All-American Cables and Radio, Inc., and RCA Victor Division.

CREI courses are prepared by recognized experts, in a practical, easily understood manner. You get the benefit of time-tested materials, under the personal supervision of a CREI Staff Instructor, who *knows* and *teaches* you what industry wants. This is accomplished on your own time, during hours selected by you, and controlled by your own will power. This complete training is the reason that graduates find their CREI diplomas keys-to-success in Radio, TV and Electronics. CREI alumni hold top positions in America's leading firms. At your service is the CREI Placement Bureau, which finds positions for advanced students and graduates. Although CREI does not guarantee jobs, requests for personnel far exceed current supply.

Now is the time of decision for you. Luck will not propel you forward unless it finds you trained. Contacts won't budge you an inch unless you have the skill to back them up. The answer is: Technical Training . . . and willingness to learn. Together they will bring you increased earnings in this new Age of Electronics. Fill out the coupon and mail it now. We'll promptly send you your free copy of "Your Future in the New World of Electronics." The rest—your future—is up to you.

MAIL COUPON FOR FREE BOOKLET

CAPITOL RADIO ENGINEERING INSTITUTE

Dept. 142D, 16th & Park Rd., N.W., Washington 10, D. C.

Send booklet "Your Future in the New World of Electronics" and course outline.

CHECK TV, FM & Advanced AM Servicing Aeronautical Radio
FIELD OF Practical Television Engineering Engineering
GREATEST Broadcast Radio Engineering (AM, FM, TV)
INTEREST Practical Radio Engineering

Name

Street

City Zone State

If residence school in Wash., D. C., preferred, check here

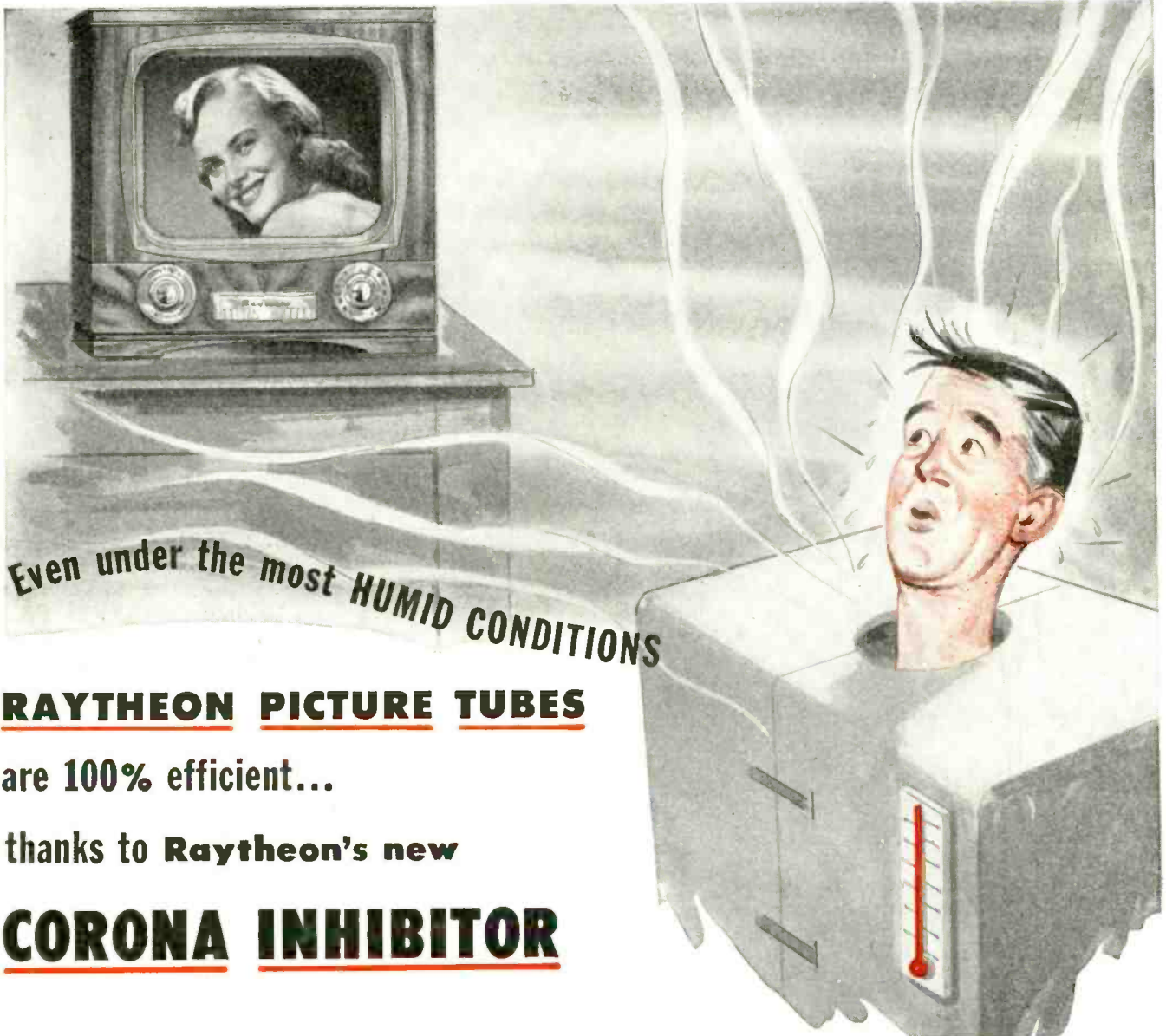

Even under the most **HUMID CONDITIONS**

RAYTHEON PICTURE TUBES

are 100% efficient...

thanks to **Raytheon's new**

CORONA INHIBITOR

Ordinary picture tubes are adversely affected by humidity and wet weather — may lose up to 10% of their brightness on damp days. Not so Raytheon made Television Picture Tubes with new CORONA INHIBITOR.

This amazing Raytheon development puts a "raincoat" on Raytheon Picture Tubes, guarantees the same *clear picture* rain or shine. Exhaustive tests proved conclusively that even under a water spray on the high voltage contact, Raytheon made Tubes showed *no loss of brightness*.

Give your customers the tubes that give constant clarity no matter what the weather. Ask your Raytheon Tube Distributor for Raytheon Television Picture Tubes.



Right for Sight!



RAYTHEON MANUFACTURING COMPANY
Receiving Tube Division

Newton, Mass., Chicago, Ill., Atlanta, Ga., Los Angeles, Calif.

Excellence in Electronics

RECEIVING AND PICTURE TUBES • RELIABLE SUBMINIATURE AND MINIATURE TUBES • GERMANIUM DIODES AND TRANSISTORS • RADIAC TUBES • MICROWAVE TUBES

Which Do You Want?



Better Pay



A Nice Home



A New Car



Greater Security



Happy Vacations and Travel

Get Your FCC Ticket
Then Use Our
Amazingly Effective
Job-Finding Service
To Get a Better Job

Add Technical Training to Your Practical Experience and

Get Your FCC COMMERCIAL RADIO OPERATOR LICENSE



I can train you to pass your FCC License Exams in a few short weeks if you've had any practical radio experience—amateur, Army, Navy, radio servicing or other. My time-proven plan can help put you, too, on the road to success.
Let me send you FREE the entire story. Just fill out the coupon and mail it. I will send you, free of charge, a copy of "How to Pass FCC License Exams," plus a sample FCC-type Exam, and the amazing new booklet, "Money Making FCC License Information." Edw. H. Gifford, Vice President

in a Minimum of Time

Get this Amazing Booklet FREE

TELLS HOW — WE GUARANTEE

TO TRAIN AND COACH YOU AT HOME
IN SPARE TIME UNTIL YOU GET

YOUR FCC LICENSE

TELLS HOW — Employers Make

**JOB OFFERS Like These
to Our Graduates Every Month**

Letter, October 11, 1951, from Chief Engineer, Broadcast Station, North Carolina. "Need men with radiotelephone 1st class license, no experience necessary. Will learn more than at average station for we are equipped with Diesel Electric power, transmitting and studio equipment."

Telegram, October 2, 1951, from Chief Engineer, Broadcast Station, Wyoming. "Please send latest list available first class operators. Have November 10th opening for two combo men."

Letter, October 8, 1951, from Chief Engineer, Broadcast Station, Texas. "Please send list of latest licensed graduates."

HERE'S PROOF FCC LICENSES ARE OFTEN SECURED
IN A FEW HOURS OF STUDY WITH OUR
Coaching AT HOME in Spare Time

Name and Address	License	Lessons
Lee Worthy 2210 1/2 Wilshire St., Bakersfield, Cal.	2nd Phone	16
Clifford E. Vogt Box 1016, Dania, Fla.	1st Phone	20
Francis X. Foerch 38 Beucler Pl., Bergenfield, N. J.	1st Phone	38

CLEVELAND INSTITUTE OF RADIO ELECTRONICS

Desk RE-38, 4900 Euclid Bldg., Cleveland 3, Ohio

FEBRUARY, 1952

TELLS HOW —

Our Amazingly Effective
JOB-FINDING SERVICE

Helps CIRE Students Get Better Jobs

Here are a few recent examples of Job-Finding Results
GETS BROADCAST JOB

"I wish to thank your Job-Finding Service for the help in securing for me the position of transmitter operator here at WCAB, in Pittsburgh."

Walter Koschik, 1442 Ridge Ave., N. Braddock, Pa.

GETS AIRLINES JOB

"Due to your Job-Finding Service, I have been getting many offers from all over the country, and I have taken a job with Capital Airlines in Chicago, as a Radio Mechanic."

Harry Clare, 4537 S. Drexel Blvd., Chicago, Ill.

Your FCC Ticket is recognized in all radio fields as proof of your technical ability.

Get All 3 FREE

MAIL COUPON NOW

CLEVELAND INSTITUTE OF RADIO ELECTRONICS
Desk RE-38—4900 Euclid Bldg., Cleveland 3, Ohio
(Address to Desk No. to avoid delay)

I want to know how I can get my FCC ticket in a minimum of time. Send me your FREE booklet, "How to Pass FCC License Examinations" (does not cover exams for Amateur License), as well as a sample FCC-type exam and the amazing new booklet, "Money-Making FCC License Information."

Tell me how I can get your Free Television Course.

Name

Address

City Zone State

Paste on penny postcard or send air mail

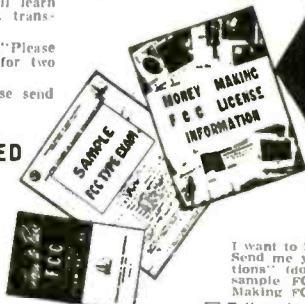

TUNG-SOL®

for
Uniformity
and
Dependability

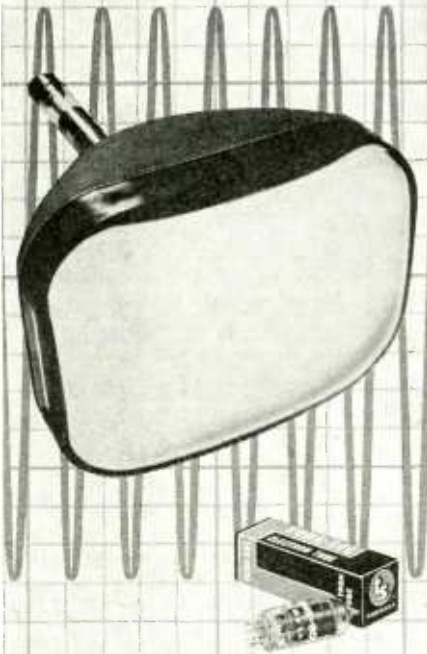

REPLACEMENT:

Tung-Sol tubes keep service standards up to set manufacturers' specifications.

INITIAL EQUIPMENT:

Tung-Sol tubes meet the highest performance requirements of set manufacturers.

TUNG-SOL
RADIO, TV TUBES, DIAL LAMPS

TUNG-SOL ELECTRIC INC., NEWARK 4, N. J.
Sales Offices: Atlanta • Chicago • Dallas • Denver
Detroit • Los Angeles • Newark

ALSO: AUTO LAMPS, ALL-GLASS SEALED
BEAM LAMPS AND SIGNAL FLASHERS

EDMUND T. FLEWELLING, inventor of the superregenerative circuit that bears his name, died at Ashburnham, Mass., December 30, 1951, as a result of injuries received when he suffered a heart attack while driving his motor car.

The Flewelling circuit—invented in 1922—dispensed with the large honeycomb coils and separate oscillators required in previous superregenerators. It used the blocking-oscillator principle, with a time constant set by three .006- μ f capacitors. Superregenerative circuits did not come into wide use till u.h.f. became common, and present-day u.h.f. receivers employ a modified Flewelling circuit.

His most recent contribution to the communications art is the Flewelling Audio System (F.A.S.), announced to the public in late 1950, and still receiving considerable attention from a section of the high-fidelity press.

Mr. Flewelling received his early electrical training under John Stone Stone. At a little later date he worked for a time with Hope Jones, the organ builder, where he obtained the knowledge of acoustics which appeared many years later in the design of the Flewelling Air Coupler, which is the chief feature of his audio system.

Subsequent to the invention of the Flewelling circuit, he contributed freely to the technical magazines of the day, and for a time was on the staff of the magazine *Radio in the Home*, a popular publication of the day. At this period he conducted experiments on shortwave reception and rebroadcast of European stations. In the late '20's he took up residence in Chicago, where he acted as consultant to the Buell Manufacturing Co., among other activities. Later he moved to Michigan, and then to Dayton, Ohio, where, besides doing work for the Kurz-Kasch Co., and for the Dayton Police Department's radio section, he established the Radio Products Co., manufacturing shortwave equipment.

He moved to Ashburnham in 1938, devoting most of his time to work on his inventions, he continued research and design work, particularly for the Wind Turbine Co., of West Chester, Pennsylvania, and for the government during World War II, and for a time operated a radio service shop. He retired from active work after developing the Flewelling Audio System, complete rights in which he sold to the Stromberg-Carlson Co.

TELEVISION FREEZE is expected to be off by April, according to recent predictions by FCC chairman Wayne Coy. Over 1,000 applications for construction permits are expected by the time the freeze is lifted.

Construction, Mr. Coy believes, will not be as rapid as the flood of applications might seem to indicate. The FCC's limited staff will slow down the processing of applications, especially in areas where the number exceeds the

channels available and hearings will have to be held.

IMPLOSION of a television tube while a new set was being installed in the home of Charles Mobely, New York City, injured two children and wrecked the set. The family was grouped closely around the receiver while the installation technician instructed them in its operation. Flying glass cut two children, and further injury was prevented only by the fact that Mr. Mobely's coat stopped a number of the high-velocity fragments.

A representative of the sales agency which sold the set stated that the cabinet was closed and the set had been operating normally for about five minutes when the tube let go. The cause of the implosion has not been definitely determined. However, an examination of the ruins of the chassis and cabinet showed that excessive pressure might be applied to the picture tube when chassis hold-down bolts were tightened.

HELICOPTERS have been added to the list of radio test instruments. One was used by WJZ-TV, New York City, to check the transmission pattern of its new antenna on the Empire State Building. Reports indicated that some areas which should be in the strong-signal range of the station were receiving weak signals. Field-strength measuring equipment in the helicopter made it possible to check the field in a fraction of the time that would have been necessary with equipment mounted in motor cars or carried by observers.

Moreover, the tests were clear and unequivocal, whereas tests taken with mobile field equipment show ambiguities due to the terrain over which the signal travels, as well as irregularities because of the difficulty of describing an exact circle around a point with equipment which is often confined to highways.

As a result, it was discovered that the theoretically circular field was actually in the form of a clover-leaf. A slight reorientation of the antenna elements and a change in electrical phasing produced a circular field, as proved by a second helicopter test.

AN ORGANIZATION for the purpose of assisting the amateur, service technician and public to solve the problems of television interference (especially interference attributed to amateur operation) has been formed in New York City. At present the membership is wholly amateur, but the organization may follow the "Dallas Plan" and invite membership representing service technicians and radio dealers.

Amateurs are urged to return to the air during the evening hours, first making sure that their transmitters will not create interference in a well engineered receiver 100 feet from the transmitter. To meet the problems which arise from sets which do not adequately reject amateur signals, the group is enlisting manufacturer cooperation. Four of the leading television manufacturers

NOW . . . GET EVERYTHING YOU NEED TO LEARN AND MASTER

TELEVISION

**RADIO-ELECTRONICS
...AT HOME!**

Use REAL commercial-type equipment to get practical experience

Your future deserves and needs every advantage you can give it! That's why you owe it to yourself to find out about one of the most COMPLETE, practical and effective ways now available to prepare AT HOME for America's billion dollar opportunity field of TELEVISION-RADIO-ELECTRONICS. See how you may get and keep the same type of basic training equipment used in one of the nation's finest training laboratories . . . how you may get real STARTING HELP toward a good job or your own business in Television-Radio-Electronics. Mail the coupon today for complete facts — including 89 ways to earn money in this thrilling, newer field.

D.T.I., ALONE, INCLUDES BOTH MOVIES and HOME LABORATORY in addition to easy-to-read lessons, you get the use of HOME MOVIES — an outstanding training advantage — plus 16 big shipments of Electronic parts. Perform over 300 fascinating experiments for practical experience. Build and keep real commercial-type test equipment shown at right

Get BOTH of these information packed publications FREE!

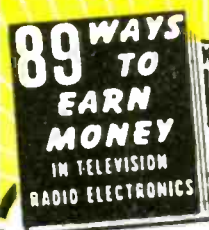

MODERN LABORATORIES

If you prefer, get all your preparation in our new Chicago Training Laboratories—one of the finest of its kind. Ample instructors, modern equipment. Write for details!

MILITARY SERVICE!

If you're subject to military service, the information we have for you should prove very helpful. Mail coupon today.

ACT NOW! MAIL COUPON TODAY!

DE FOREST'S TRAINING, INC. Dept. RE-2-1
2533 N. Ashland Ave., Chicago 14, Ill.

Without obligation, I would like your Opportunity News Bulletin showing "89 Ways to Earn Money in Television-Radio-Electronics"; also, the folder showing how I may prepare to get started in this thrilling field.

Name.....Age.....
Address.....Apt.....
City.....Zone.....State.....



ABOVE: Build and keep a real 17 INCH commercial TV receiver. Optional after completing regular training at moderate added cost.

Here's the REAL THING!

SET UP YOUR OWN HOME LABORATORY

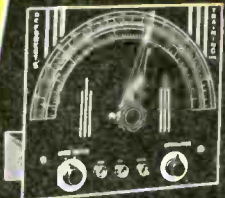

R-F Signal Generator

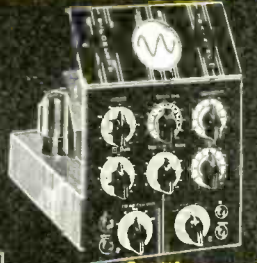

Oscilloscope



6-Tube Radio

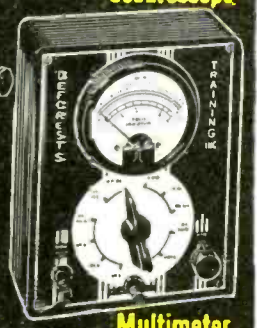

Multimeter

Home Movies

"ONE OF AMERICA'S FOREMOST TELEVISION TRAINING CENTERS"

De FOREST'S TRAINING, INC.
CHICAGO 14, ILLINOIS
A De VRY INSTITUT CN

only \$67⁵⁰
for this

"Challenger"

tube tester
by JACKSON



■ As the name implies, we ask you to compare our "Challenger" instruments with any and all others at anywhere near the price.

In the Model 115 "Challenger" Tube Tester, the famous Jackson *Dynamic*® test principle is employed. Separate voltages are applied to each tube element. Tests can be made under actual use conditions.

A feature of this instrument is the high voltage power supply. It affords more accurate results because of high plate voltages—over 200 v. for some types of tubes.

Spare socket positions are pro-

vided for future use, thus avoiding obsolescence. Push-button and selector switch controls simplify operation. The 4-inch-square meter is easy to read. The instrument gives complete short tests. It is applicable to over 700 types of tubes including TV amplifiers and rectifiers. The built-in roll chart is frequently revised to provide data on new tubes. This service is free for one year.

Finish is attractive Challenger Green with harmonizing knobs, meter cover, and push-buttons. Size, as of all "Challenger" instruments, is 13" x 9½" x 5½". Weight, 11 lbs.

Each of these "Challenger" instruments

\$59⁵⁰



Condenser
Tester
Model
112

Push-button controlled. Provides quick positive range selection for capacity and leakage tests. Shows up all types of faulty condensers, using a new method for detecting leakage. No need to count flashes on the electron ray tube indicator! Test voltages from 20 v. to 500 v. in six steps. Glass-enclosed dial with Jackson "Scale Expander" pointer which doubles effective scale length. Power factor measured on Direct Reading Scale calibrated from 0 to 60%. Ranges from .00001 to 1000 mfd in four steps.

Test
Oscillator
Model
106



Here's a "Challenger" instrument for testing AM and FM radios. It is also used as an auxiliary TV marker generator. Range of fundamental frequencies is 100 kc to 54 mc . . . Harmonics calibrated 54 mc to 216 mc. Two-circuit attenuator controls signal strength. 400 cycle audio modulation, or may be used for straight RF unmodulated signal. Accuracy is ½ of 1% in all ranges. Same finish and dimensions as other "Challenger" instruments. Compare this instrument with any low-priced signal generator or with any so-called kit.

have already responded to letters from the organization, promising to correct any interference problems in their sets for which harmonic-free amateur transmitters may be blamed. (See page 40.)

RADIO SECURITY MEASURES intended to prevent radio and TV stations from becoming homing beacons for enemy bombers and guided missiles in the event of an attack, were initiated by an executive order signed by the President Truman. The order implements legislation passed by Congress in October and empowers the FCC to draft regulations affecting all privately owned broadcasting and communications stations, or other devices "capable of emitting electromagnetic radiations between 10 kilocycles and 100,000 megacycles which are suitable for use as a navigational aid beyond five miles".

Such regulations shall become effective only after approval by the Secretary of Defense and the chairman of the National Security Resources Board. The order is intended to go into effect only in the event or threat of an air attack, and embodies suggestions arising from conferences between FCC officials and representatives of the radio networks and National Association of Radio and Television Broadcasters.

The order forbids the FCC from using or taking over any station, or exercising any control over the content of broadcasts. The agency is empowered to stop or limit a station's broadcasts but is required to permit operations "at the earliest possible time consistent with national security".

AN AIRBORNE RADAR NETWORK has been proposed and patented by David Sarnoff, chairman of the board of RCA. Subsequently assigned to RCA, the patent embracing an "automatic early warning system" which is intended to detect enemy ships and planes far out at sea and even intercept and turn back guided missiles carrying deadly loads.

The proposal envisages a succession of radar-equipped planes moving continuously across possible invasion routes, and whose lead planes relay information through trailing planes to a central control station. The central station would also be equipped to jam the telemeter signals transmitted by the enemy to and from the guided missile and even to take counter-control of the missile.

HAZLETON, PA., has joined the localities receiving TV via a coaxial cable installation, on a subscription basis.

A tower erected on nearby Jeanesville Mountain will provide reception of Channels 3, 6, and 10, with 5 and 12 to be added later. Tap-in fees are not expected to exceed \$100 a set, with a monthly rental of \$3.50.

Hazleton, the highest city in Pennsylvania, has an estimated 2,500 private TV set installations, but this figure is expected to be doubled after the cable installation.

—end—

JACKSON ELECTRICAL INSTRUMENT CO.
"Service Engineered" Test Equipment DAYTON 2, OHIO In Canada: The Canadian Marconi Co.



Leonard C. Lane
 B.S., M.A., Exec. Dir. of Pierce School of Radio and Television Licensed by the State of N. Y.
 President of Radio-Television Training Association. Approved as a Correspondence School under the Laws of the State of N. Y.

TELEVISION NEEDS YOU FOR TOP PAY JOBS

I GIVE YOU COMPLETE TRAINING AT HOME IN YOUR SPARE TIME — IN A SHORT TIME!

I GIVE YOU **15** BIG TV-RADIO KITS
 Build & KEEP this Giant-Screen TV Set & other units shown **YOURS TO MAKE AND KEEP**
 PLUS a C-W Telephone Receiver,
 AC-DC Power Supply unit (not shown here)

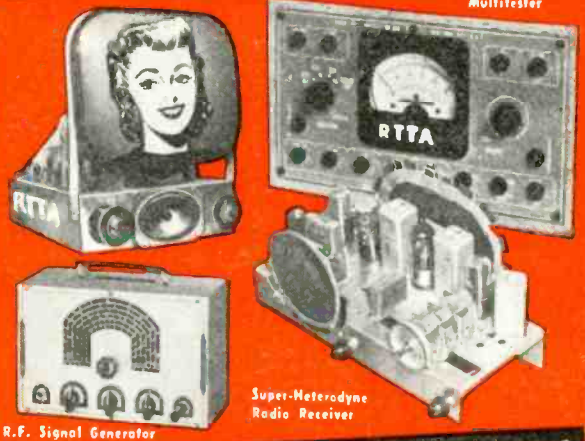

I GIVE YOU A ROUND TRIP TO NEW YORK CITY

From wherever you live in the U. S. or Canada. Yes, I pay your way. After you finish your home-study course, you can study with me, here, in the heart of the radio and television world. Two weeks, 50 hours, advanced instruction using the most modern electronic equipment at world-famous Pierce School of Radio & Television, PLUS operating Pierce Radio Station and Pierce TV Station (both operated by students), PLUS Code Machine Set Up. I take you behind the scenes of New York's Radio-TV Stations—to study first hand! You learn BEST with the BEST!
 (This offer applies to complete Radio-TV course only)

PLUS THESE BIG "EXTRAS"
 • Only RTTA gives you a home study course in RADAR at no extra cost!
 Learn the secrets of "the Electronic Miracle"—RADAR!
 • RTTA helps you prepare for your FCC license with FCC STUDY AIDS, which are provided as part of this course . . . at no extra cost!

Men! Television is a billion dollar industry growing amazingly day by day, right before our eyes. See how big it is already—and yet see how many sections of the country are still waiting eagerly for Television. Get in on the ground floor of AMERICA'S FASTEST GROWING BIG INDUSTRY . . . NOW! Don't let this chance pass you by. Demand for trained radio-TV men will far outstrip supply for years and years.

EARN EXTRA MONEY IN YOUR SPARE TIME
 Keep your job. Make as much as \$5 an hour extra, while learning. Fix neighbors' and friends' radios and TV sets. I show you how! Many students pay for entire training out of spare time earnings!

BECOME A CERTIFIED TV TECHNICIAN
 RTTA Shop-Methods are widely acclaimed because they're so practical. Step by step you learn how by doing. RTTA is tops for recognition by leading companies.

EARN GOOD PAY — OR START YOUR OWN BUSINESS
 My trained graduates are holding good jobs at NBC-TV, CBS-TV, RCA, DUMONT, EMERSON, PHILCO, ADMIRAL, HUGHES AIRCRAFT — and many more radio and TV stations, electronic firms, and telephone systems. If you prefer, get a good job installing and servicing radio-TV sets—or start your own business. You can write your own ticket in this big industry. Be independent. Well-trained technicians earn respect.

NO PREVIOUS TRAINING NEEDED
 Even with a grammar school background you can master RTTA methods which are based on practical "learn by doing." You work out the problems. You set up and use the apparatus as per RTTA simple directions. It's easy, you learn fast, and before you know it, you're an expert technician.

I TRAIN MEN FOR SUCCESS!

9/14/51 "My FCC License plus your practical Shop-Training Methods upped my earnings. Highly recommend your school."—J. Stapleton

12/20/51 "Your training prepared me for this TV Technician job with security. I'll always be glad I chose your school."—Gil Grossinger

6/15/51 "I can look forward to a profitable future, as a TV Ser. Tech., thanks to your training."—I. Samuels

8/10/51 "It takes your type of training to get good jobs. As a TV Tech. I make good money."—Bill Atkinson

NOW! ADVANCED FM AND TV TRAINING FOR YOU MEN WHO KNOW RADIO
PREPARES YOU FOR HIGHER PAY TV JOBS IN A FEW MONTHS
 An accelerated plan for radio service men — six (6) kits furnished — yours to build and keep including large screen TV receiver — plus making scores of experiments.



EARN EXTRA PAY IN UNIFORM
 Learn how RTTA's home study can qualify you for military specialist ratings in Army, Navy and Air Force—more prestige, better duty and more pay! Plus a secure future when you return to civilian life! Learn the facts. Mail the coupon right now!

RADIO-TELEVISION TRAINING ASSOCIATION
 1629 BROADWAY — RADIO CITY STATION
 NEW YORK CITY 19, NEW YORK



FREE SAMPLE LESSON. BIG FREE MANUAL

BOTH FREE

THIS COUPON GOOD FOR BOTH. MAIL TODAY!

Mr. Leonard C. Lane, President Dept. 24
 RADIO-TELEVISION TRAINING ASSOCIATION
 1629 Broadway, Radio City Station
 New York 19, N. Y.

Dear Mr. Lane: Show me how I can make BIG MONEY IN TELEVISION within MONTHS! Rush by return mail my FREE Sample Lesson and BIG FREE Manual.

Name

Address

City Zone State

(PLEASE PRINT PLAINLY) Age

MERIT

TV full-line* Components For
Improvement, Replacement, Conversion



SELL IMPROVED RECEPTION

MERIT "TV" Kit #1000 for edge to edge focus—contains MDF-70 Cosine Yoke, HVO-7 Universal Flyback and MWC-1 Width Linearity Control. Keep a Kit handy—you'll get plus business and a reputation for "know-how."



MDF-70 . . . original of the "cosine" series—low horz, high vert inductance. Used by such famous sets as

Radio Craftsman. Cosine Yokes will improve 10,000,000 sets now in use!

MERIT...HQ for TV Service Aids

MERIT's 1952 Catalog #5211 now available . . . introducing MERIT IF-RF Coils, includes Coil & Transformer data, listings. Other MERIT service aids: TV Repl Guide #404, Sept. '51 issue—covers 3000 models, chassis of 82 mfrs; Cross Ref Data on IF-RF Coils, Form #14. Write: Merit Coil and Transformer Corporation, 4425 North Clark Street, Chicago 40.

These three MERIT extras help you:

- Exclusive: Tape-marked with specs and hook-up data
- Full technical data packed with every item
- Listed in Howard Sams Photo-facts



*Merit is meeting the TV improvement, replacement and conversion demand with a line as complete as our advance information warrants!



BURTON BROWNE ADVERTISING

Merchandising & Promotion

Shure Brothers, Chicago, announced that its line of pickup cartridges is now being packaged in new "push-out" pillbox type individual containers. The new package provides an individual box with a cartridge mounted on a platform containing the accessories inside it.

La Pointe-Plascomold Corp., Windsor Locks, Conn., released a four-page circular describing its new Vee-D-X single channel mast-mounted Rocket booster.

The company also announced an accelerated advertising and sales promotion program for 1952 which will be devoted to the regular line of Vee-D-X products and a series of major new products to be released in the near future.

Allen B. Du Mont Laboratories, Cathode-Ray Tube Division, Clifton, N. J., released a new version of its TV Picture Tube Selector, originally introduced last September. The tube listings have been increased and a space has been provided for imprinting the distributor's name. The Selector is available to technicians through Du Mont Teletron distributors.

JFD Manufacturing Co., Brooklyn, N. Y., designed a new package for its "Little Giant" lightning arresters. Called the "Handi-Pak," it holds six smaller boxes each containing one AT-105 arrester with hardware and instal-

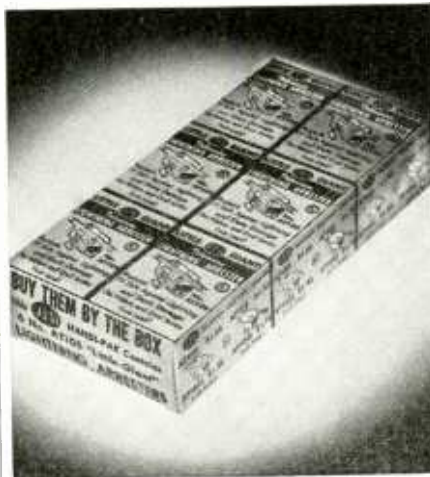

lation instructions. The new package permits easier stocking and provides an attractive point of sales display.

The Brach Manufacturing Corp., Newark, N. J., announced a new consumers' postcard mailing campaign on its antennas and 2-set couplers. The postcards are distributed by Brach distributors to dealers who in turn send them to customers. In cartoon form, the cards show why the TV consumer should ask his dealer for Brach TV products.

The Hickok Electrical Instrument Co. Cleveland, O., released a series of brochures describing its tube tester and set analyzer, vacuum-tube volt-ohm-milliammeter and termination pads.

Production & Sales

The RTMA announced that 314,932,857 receiving tubes had been sold in the first ten months of 1951 as compared with 304,910,357 during the correspond-

ing 1950 period. Of the total tubes sold in 1951, 211,273,000 were sold for new sets, 78,940,247 for replacements and the balance for government agencies and export.

The NBC TV Sales Planning & Research Department announced that 15,176,200 TV sets had been installed in the United States as of December 1st. There were 2,720,000 in New York City, 1,065,000 in Los Angeles, 1,060,000 in Chicago, 970,000 in Philadelphia, and 833,000 in Boston.

New Plants & Expansions

General Electric announced that it would use two buildings and a part of a third in Bridgeport, Conn., for the design and manufacture of military electronic equipment.

Allen B. Du Mont, Cathode-Ray Tube Division is now warehousing Du Mont television picture tubes in Los Angeles and San Francisco. Warehouse stock is under the supervision of the W. C. Hitt Co., Du Mont sales representative in Los Angeles and San Francisco.

Sylvania Electric Products, Inc., opened its new radio tube plant in Shawnee, Okla.

Tel-O-Tube Corp. of America, East Paterson, N. J. purchased the equipment and inventory of the Video Industry Products Co., Paterson, N. J., manufacturers of television and cathode-ray tube test equipment and electronic instruments. The move will enable Tel-O-Tube to expand its facilities into large scale production of test equipment and electronic instruments.

CBS-Columbia, Inc., Brooklyn, N. Y. launched a \$5,000,000.00 expansion program with the purchase of additional manufacturing space for the production of television and radio receivers in Long Island City, N. Y.

The Simpson Electric Co., Chicago, is nearing completion of an addition to its Lac Du Flambeau, Wis. branch. The additional space will be used to provide more assembly lines for Simpson test equipment and panel meters.

The International Rectifier Corp. purchased a new factory building in El Segundo, Cal. which will house both sales and administrative offices. The company's present plant in Los Angeles will be maintained for research and development.

Video Products Corp., manufacturers of television receivers, moved its national sales office to larger quarters at 370 7th Ave., New York City. The factory remains in Red Bank, N. J.

Centralab Division of Globe-Union, Inc., Milwaukee, introduced a new color-code chart which is the first chart to include all the color-coding requirements of the entire electronic industry, according to W. S. Parsons, Centralab vice-president. The chart will be initially distributed through Centralab representatives and jobbers. Later it will be made available to anyone at a nominal charge.

Stromberg-Carlson, Rochester, N. Y., held dedication ceremonies for its new sound equipment division building.

The Crosley Division of Avco Manufacturing Corp. has begun construction

always
in stock at
ALLIED



**exceptional
quality and value**

Choose reliable equipment for your service or lab bench—and save! Order Triplet test instruments from ALLIED—for top value and continuously dependable service.

OUTSTANDING VALUES IN DEPENDABLE VOLT-OHM-MILLIAMMETERS



Model 630: 33 Ranges
For high accuracy testing of TV and other high-resistance circuits. Completely enclosed single selector switch; 5 1/2" meter with 4 3/8" scale. Uses 1% resistors, each sealed separately in bakelite. "Unit-constructed"—provides direct connections without cabling. Ranges: DC and AC volts, 0-3-12-60-300-1200-6000, DC at 20,000 ohms/v, AC at 5000 ohms/v; DC current 0-60 microamps, 0-1-2-12-120 ma. and 0-12 amps; res. 0-1000-10,000 ohms and 0-1-100 megs; db. -30 to +70 in 6 ranges; output v., 0-3-12-60-300-1200-6000, 20-position switch selects both circuit and range. Black molded case, 3 1/2 x 5 1/2 x 7 1/2". With batteries, 50" leads. Shpg. wt., 4 1/2 lbs. 84-568. Only.....\$38.71

Model 630-A. As above but uses 1/2% resistors for greater accuracy. With mirror scale. 84-574. Only.....\$48.51

New Model 650
A compact, highly sensitive instrument with single selector switch for all ranges. Complete frequency coverage from 20 cps to over 140 mc with one probe. Ranges: DC v., 0-1-5-10-50-100-500-1000; AC-RF v., 0-1-5-10-50-100-500; peak-to-peak v., 0-2.8-14-28-140-280-700; ohms, 0-1000-10,000-100,000-1 meg. -100 meg. -1000 meg. Has large 5 1/2" meter with 4 3/8" scale; separate 1 ACV and 5 ACV scales for greater accuracy; high input impedance 11 meg. on DC for accurate measurements without loading circuit under test. In molded case, 3 3/4 x 5 1/2 x 7 1/2"; complete with power cord, DC v. and ohms lead, AC-RF volt tube probe, battery. Shpg. wt., 6 lbs. 84-558. Only.....\$68.11
84-563. UHF Probe flat from 20 kc—980 mc, using 9005 diode. Only.....\$16.17
84-564. HV Probe. Only.....\$14.21



Popular Model 666R

An economical, dependable pocket-size VOM featuring a single range-selector switch. Only 2 controls—the range switch and the ohms adjust control. 1000 ohms-per-volt sensitivity on AC and DC volt ranges. Red Dot 3" 0-200 microammeter movement with 250 millivolt sensitivity. Ranges: DC and AC volts, 0-10-50-250-1000-5000; DC ma, 0-10-100; DC amps, 0-1; ohms, 0-3000-300,000; megs., 0-3. Provision for connecting external resistors to extend current ranges. Parts housed in base integral with selector switch. Black molded insulated case and panel. Size: 3 1/8 x 5 1/8 x 2 1/8". Supplied complete with batteries, 50" test leads with banana plugs and alligator clips. Shpg. wt., 3 lbs. 84-557. Only.....\$25.97



Model 666 Rl. Same as above, but in camera-type black leather case. May be used without removal from case. Shpg. wt., 4 lbs. 84-538. Only.....\$31.85



Model 3413A Tube Tester
Tops for flexibility and simplicity. Has slide-lever switches numbered to correspond with RTMA tube pin numbers, and connected to bring out each active tube element. Simple up or down motion of the lever instantly makes connection. Tests all modern tubes (including the new 9-pin noval type), pilot lamps, ballast tubes, resistors, etc. Oversize 6" Red Dot lifetime guaranteed meter gives quick, accurate BAD—?—GOOD tests. Checks emission, shorted and open elements. Built-in Speed-Roll chart. Counter-portable case. 15 1/2 x 11 1/2 x 6 1/8". For 110-120 v., 50-60 cycles. Shpg. wt., 28 lbs. 84-591. Only.....\$77.91

TYPE BV ADAPTOR. Checks TV picture tubes with 3413A. Shpg. wt., 1 lb. 84-539. Only.....\$7.74

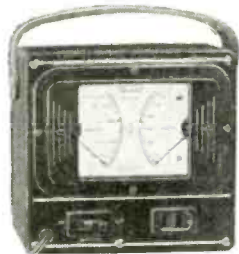

Model 660 Load-Chek
Wattmeter-voltmeter invaluable for service work. Tests by power consumption measurement. Quickly detects overloads caused by shorts. Also indicates whether replacement resistors have sufficient power handling capacity. Shows total power being drawn from line by unit under test. Just plug the chassis into the Load-Chek. If equipment draws excess power, you can check chassis with soldering iron and pliers. Not necessary to lay down tools or to check with test leads. Ranges: 0-500-1000 AC-DC watts; 0-130 AC-DC volts. Housed in black molded case. 6 x 5 1/2 x 2 1/2". Shpg. wt., 3 lbs. 84-537. Only.....\$28.91

Model 3441 TV-FM Oscilloscope

Features push-pull vertical and horizontal amplifiers. Vertical response usable beyond 4 mc. Horizontal, 20 cps to 150 kc; deflection sensitivity, .1 rms v/inch. Vertical input impedance, 2 megs, 20 mmf (with probe). Reads peak-to-peak volts, 0-1000 in 8 ranges. Linear sweep: 10 cps to 60 kc/second. Phased 60 cycle horizontal sweep and return trace eliminator for use with sweep generators. Synchronizing and horizontal sweep selector combined in one simple control. Has phone jack for hearing wave-form under observation; simplifies audio circuit tracing. Uses 5" cathode-ray tube (5UPL). Fully shielded and fused. Complete with tubes, 2 coaxial cables, rubber-covered test leads, low capacity probe and instructions. Size: 15 1/2 x 16 x 11 1/2". For 105-125 volts, 50-60 cycles AC. Shpg. wt., 65 lbs. 84-530. Only.....\$195.51



ALL TRIPLET TEST EQUIPMENT IS AVAILABLE FROM ALLIED

We can supply promptly any test instrument made by Triplet, including the following models:

84-575.	Model 625-NA Volt-Ohm-Milliammeter.	Only.....	\$ 48.51
84-555.	Model 666-NH Volt-Ohm-Milliammeter.	Only.....	24.01
84-592.	Model 3432 Signal Generator.	Only.....	77.91
84-534.	Model 3434A Sweep Generator.	Only.....	195.51
84-532.	Model 3435 Sweep Generator.	Only.....	112.21
84-533.	Model 1235 Marker Generator.	Only.....	28.91

All Triplet instruments over \$45 available on Easy Terms—ask for details.

FREE 212-PAGE 1952 BUYING GUIDE

Send today for ALLIED's authoritative, complete catalog, listing the world's largest stocks of tubes, parts, test instruments, audio equipment, industrial components—everything in electronics at lowest prices. Look to ALLIED for speedy delivery, expert personal help and complete satisfaction. Get your FREE catalog now.



ALLIED RADIO

ALLIED RADIO CORP., Dept. 2-B-2
833 W. Jackson Blvd., Chicago 7, Ill.

- Send FREE 1952 Allied Catalog.
- Please ship the following Triplet instruments.....

.....\$.....enclosed

Name.....

Address.....

City.....Zone.....State.....



\$10.00

FOR YOUR CARTOON IDEA

Have a pet peeve about service customers and their peculiarities? Help us keep the above "SERVICEMAN'S DIARY" cartoon series going by sending in your idea. No need to draw it—just write it out. Sprague will pay \$10.00 for every idea that is used.

Unequaled Dependability

Actual service records prove that Sprague Twist-Lok dry electrolytic capacitors are tops for keeping you out of trouble with service customers—by keeping their TV sets working right!

And Sprague has the *most* complete listing of *every type* of television electrolytic. Ask your Sprague distributor for a catalog or write to: SPRAGUE PRODUCTS COMPANY, 81 Marshall St., North Adams, Mass.



TWIST-LOK* 'LYTICS

The easiest to use, most reliable electrolytics
for television replacement use

(Sprague Products Co. is the Distributors' Division of the Sprague Electric Co.)
* T.M.

on a \$5,500,000 defense production plant in Evendale, O.

The Andrew Corporation, Chicago, manufacturer of transmission lines and antenna equipment announced the formation of the Andrew California Corporation, Simi, Cal. to handle the company's California business.

Thomas Associates, Los Angeles, established a branch manufacturing plant at Coffeyville, Kans., for the production of "TA" clips, clamps and similar items.

Business Briefs

... Wayne Coy, Chairman of the FCC predicted that there would be between 1,200 and 1,500 new television stations within the next five years.

... The RTMA Board of Directors conducted an informal poll of estimates of 1952 set production among those in attendance at the Board of Directors meeting in Chicago. Guesses of TV production ranged from 3,000,000 to 5,000,000. The average was 4,440,000. Estimates of radio production averaged 10,900,000; 12,500,000 was the highest and 7,500,000 was the lowest.

... Howard W. Sams & Co., Indianapolis announced two new innovations in the company's Photofact folders. First:—The reproduction of actual wave forms, taken at representative points in the TV receivers, will be included in standard notation schematics. Second:—Voltage values will be incorporated in standard notations at the tube pins.

... The RTMA announced the admission of four new members to the association:—Electronic Devices, Inc., Brooklyn, N. Y., Mosley Electronics, Overland, Mo., Radio Materials Corp., Chicago, Redmond Co., Inc., Owosso, Mich.

... Allen B. Du Mont Electronic Parts Division announced a new plan under which replacement parts for Du Mont TV sets would be available to service technicians through distributor channels. Previously, such parts were available only from the manufacturer or receiver distributor. The Cathode-Ray Tube Division announced a new cathode-ray picture tube guarantee providing protection for the receiver manufacturer for six months from the date of actual installation of a receiver in the consumer's home. This plan provides the same protection for TV manufacturers as previously enjoyed by distributors and service technicians.

... The Precision Electronic Research Co., was formed in Garland, Texas to manufacture the *Perco* line of products including lightning guards, 15-ampere twin-lead, and other items.

... The 1952 Western Electronic Show and Convention was voted as the new name of the annual Pacific Electronic Exhibit. It will be held in Long Beach, Cal., August 27th to 29th. D. E. Larson, advertising manager of Hoffman Radio Corp., was appointed publicity chairman for the show.

... The Cincinnati Section of the Institute of Radio Engineers will hold its Spring Technical Conference on April 19th.

—end—

130,000 qualified TV servicemen needed

Here is how you can be one of them

INDUSTRY EXPERTS HAVE ESTIMATED over 130,000 qualified TV technicians will be needed for the installation, trouble-shooting and repairing of the television receivers in use by 1955.

There are far fewer than 50,000 fully trained TV technicians available today. This means more jobs, unrivaled future for security, greater earning power for thousands and thousands of additional TRAINED and EXPERIENCED TV Servicemen. Will you be one of them?

OUTSTANDING FUTURE FOR QUALIFIED TV SERVICEMEN

Men now in radio servicing as well as men in the radio-electronics industry with no experience in TV servicing . . . here is your opportunity. The RCA Institutes Home Study Course in Television Servicing makes it possible for you to convert your skill in radio servicing, or interest in radio-electronics, to the important money-making field of TV servicing.

The RCA Institutes Course gives you a sound knowledge of television fundamentals . . . intensive practical instruction in the proper maintenance and servicing of complex TV receiver circuits—including color TV and UHF . . . teaches you the "short cuts" on TV installation and trouble-shooting, saving you many hours of on-the-job labor.

TRAINING MEETS MODERN REQUIREMENTS

This course is in step with the progress of the television industry. It is backed by RCA—pioneer in television development. It is based on the actual experience of the RCA Service Company in servicing thousands of home television receivers. The

course is constantly being revised, improved and kept up-to-the-minute. It will help you to a more profitable and productive future in these ways:

PREPARE YOU to take the required technical examination with confidence, in those areas that require a license or permit to engage in TV servicing.

TRAIN YOU, if you are a serviceman in a non-TV area, to become a qualified TV technician by the time TV comes to your area. In TV areas, TV servicing has substantially replaced radio servicing as the chief source of income.

IF YOU ARE A QUALIFIED TV SERVICEMAN, it will keep you in step with the latest industry developments including color TV and UHF.

IT DEVELOPS the latent talents of installers into skilled trouble-shooting TV technicians.

TRAINS MEN in radio-electronics with no previous servicing experience to fill jobs as TV technicians, to win promotions and better pay.

RCA INSTITUTES HOME STUDY COURSE PLANNED TO YOUR NEEDS

You keep your present job in radio—television—electronics. In your spare time, you study at home. You learn "How-to-do-it" techniques with "How-it-works" information in easy-to-study lessons prepared in ten units. Cost of RCA Home Study Course in Television Servicing has been cut to a minimum—as a service to the industry. You pay for the course on a "pay-as-you-learn" unit lesson basis. You receive an RCA Institutes certificate upon completion of the course. The RCA Institutes Home Study Course in Television Servicing is approved by leading servicemen's associations.

RCA Institutes conducts a resident school in New York City offering day and evening courses in Radio and TV Servicing, Radio Code and Radio Operating, Radio Broadcasting, Advanced Technology. Write for free catalog on resident courses.

Send for FREE BOOKLET

Mail the coupon—today. Get complete information on the RCA INSTITUTES Home Study Course in Television Servicing. Booklet gives you a general outline of the course by units. See how this practical home study course trains you quickly, easily. Mail coupon in envelope or paste on postal card.



MAIL COUPON NOW!

RCA INSTITUTES, INC.
Home Study Department, RE-252
350 West Fourth Street, New York 14, N.Y.

Without obligation on my part, please send me copy of booklet "RCA INSTITUTES Home Study Course in TELEVISION SERVICING." (No salesman will call.)

Name _____ (Please Print)

Address _____

City _____ Zone _____ State _____



RCA INSTITUTES, INC.

A SERVICE OF RADIO CORPORATION OF AMERICA
350 WEST FOURTH STREET, NEW YORK 14, N.Y.

FEBRUARY, 1952

**All UHF channels...
for all TV sets**

MALLORY UHF CONVERTER

The Mallory UHF converter is right for *all* your TV customers because it can be used with *any* TV set... in *any* UHF broadcast area. And it's easy to install—no adjustments or connections to make in the TV set... just connect power lines and antenna leads.

These Mallory features mean real customer satisfaction... real sales for you in the new UHF market—

- Reception of all UHF channels
- No sacrifice of VHF channels
- Built-in UHF antenna
- High quality picture definition
- Fast, easy installation

No larger than a small portable radio, the Mallory UHF converter is precision-built for long, trouble-free service. Get complete details today on the Mallory UHF converter from your Mallory distributor.

P. R. MALLORY & CO. INC.
MALLORY CAPACITORS... CONTROLS... VIBRATORS...
 SWITCHES... RESISTORS... RECTIFIERS...
 VIBRAPACK* POWER SUPPLIES... FILTERS
*Reg. U.S. Pat. Off.

APPROVED PRECISION PRODUCTS

P. R. MALLORY & CO., Inc., INDIANAPOLIS 6, INDIANA

*Make Sure...
Make it Mallory*

NANTOOK MOOK WALSCO ONKO

(translation)

"BETTER FRINGE AREA RECEPTION WITH WALSCO MODEL M ANTENNA"

There's a magical difference in WALSCO Model M Signal King performance almost *anywhere*. In the fringe areas, or wherever weather is the roughest, the Model M will out-perform, out-last any competitive antenna.

Once you install ... *that's all*. No costly call-backs that steal your profit. Model M is guaranteed sturdier, more dependable in *any climate*. Chromate-coated magnesium cross-arms have a structural strength almost equal to steel, yet $\frac{1}{3}$ lighter than aluminum. Positive corrosion resistance even in severest weather. Elements are made of high-conductivity, super strength aluminum alloy, reinforced with Swiss "Permalum." WALSCO Model M is quality you can trust *anywhere*.

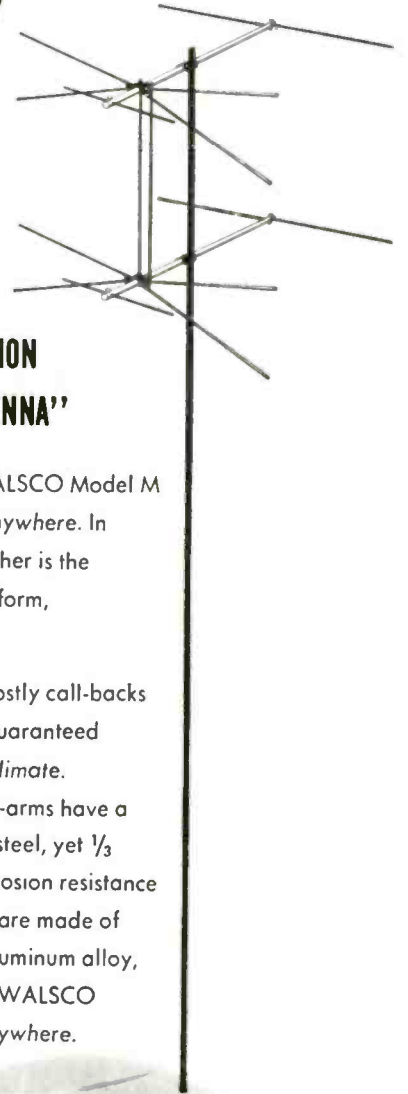

WALSCO

Walsco quality earned its reputation

WALTER L. SCHOTT CO.

3225 Exposition Place, Los Angeles 18, Calif.
Branch: Chicago 6, Illinois

EICO

TEST INSTRUMENTS

guards

Majestic
HIGH STANDARDS OF
TELEVISION PRODUCTION QUALITY



In the Majestic design laboratories, Frank J. Diell and assistant, Paul Smith, discuss with Harry R. Ashley, some important prototype-circuit measurements just taken with the 425 Oscilloscope, #221 VTVM and #HVP-1 HV Probe.

Frank J. Diell, Majestic's Chief Engineer, and Harry R. Ashley, President of EICO, inspecting the use of the EICO Model 425 5" Push-Pull Oscilloscope, Model 221 Vacuum Tube Voltmeter and Model HVP-1 High Voltage Probe at the important Final Test Position on the Majestic Television production lines.

KITS - Wired Instruments

For Laboratory Precision at Lowest Cost—
the Leaders Look to **EICO!**

WHY does The Majestic TV Division of The Wilcox-Gay Corp., another one of America's leading TV manufacturers, specify EICO Test Instruments on both its production lines and in its design laboratories?

BECAUSE—like Emerson, Tele-King, Tele-Tone, CBS-Columbia, and many another famous TV manufacturer coast to coast, Majestic knows that

- ONLY **EICO** TEST EQUIPMENT DELIVERS ALL TO **EICO** NOMINAL FEATURES
1. Laboratory Precision
 2. Lowest Cost
 3. Lifetime Dependability
 4. Speedy Operation
 5. Rugged Construction
 6. Quality Components
 7. Latest Engineering
 8. Super-Simplified Assembly and Use Instructions
 9. Laboratory-Styled Appearance
 10. Exclusive EICO Make-Good Guarantee

Before You buy any higher-priced equipment, be sure You look at the **EICO** line—in **Wired** as well as **Kit form!** Each **EICO** product is jam-packed with unbelievable value. **YOU** be the judge—compare, see **EICO** instruments today—in stock at your local jobber—and **SAVE!** Write **NOW** for **FREE** newest Catalog 2-C.

FOLLOW THE LEADERS...INSIST ON **EICO!**



NEW 425K 5" PUSH-PULL SCOPE KIT \$44.95. WIRED \$79.95



NEW 221K VTVM KIT \$25.95 WIRED \$49.95



HIGH VOLTAGE PROBE \$6.95



NEW 555K MULTIMETER KIT \$29.95. WIRED \$34.95
20,000 ohms/volt

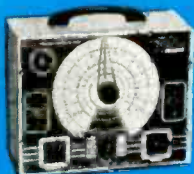

NEW 930K R-C BRIDGE & R-C COMP. KIT \$19.95
WIRED \$29.95



320K SIG. GEN. KIT \$19.95. WIRED \$29.95
NEW 322K SIG. GEN. KIT \$23.95. WIRED \$34.95



NEW 1040K BATTERY ELIM. KIT \$25.95. WIRED \$34.95



511K VOM KIT \$14.95
WIRED \$17.95



NEW 625K TUBE TESTER KIT \$34.95
WIRED \$49.95



NEW 526K MULTI-METER KIT \$13.90 WIRED \$16.90
1000 ohms/volt

NEW 1171K RES. DECADE BOX KIT \$19.95 WIRED \$24.95



NEW 315K DELUXE SIG. GEN. KIT \$39.95
WIRED \$59.95

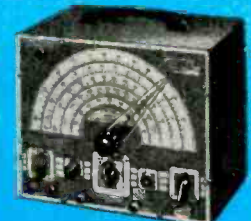

360K SWEEP GEN. KIT \$34.95
WIRED \$49.95



145K SIG. TRACER KIT \$19.95
WIRED \$28.95

EICO

ELECTRONIC INSTRUMENT CO., INC.
84-86 Withers Street, at Meeker Ave., Brooklyn 11, New York

©1951

Prices 5% higher on West Coast. Due to unstable conditions, prices and specifications are subject to change without notice

TELEVISION SERVICING

... Television and radio servicing differ significantly ...

By HUGO GERNSBACK

More and more does the television servicing industry recognize the important fact that—while television servicing has its roots in the methods of radio repair—it has major problems of its own. While the two run along roughly parallel lines, they tend to diverge more and more as time goes on.

When television first burst upon the radio servicing industry a few short years ago, every radio technician thought that his methods were adequate to service any and all television receivers. It was soon found that such was not the case. While it is true that you must have a good radio foundation before you can hope to successfully service a television receiver, the problem is sufficiently different that we must re-orient ourselves if we are to succeed in television.

There was a time when the average service technician would prefer to remove a radio receiver from the premises and service it in his own shop. This was easy because the weight of the set usually was low. But the weight of the average televiser—from 100 pounds up—soon made this impractical, on account of the heavy physical work entailed.

The large and successful television service organizations today remove fewer and fewer receivers from the customer's premises. This is because the cost of transportation, the inconvenience to the customer, the trucking—all of which are expensive and time-consuming—make it no longer advisable or profitable. Hence, a large percentage of our television sets now are being serviced in the owners' homes, with gratifying results. This change in *modus operandi* necessitates a new approach in service thinking.

One of the most successful servicing organizations now dispatches its technicians equipped with up-to-date servicing instruments, necessary tools, and replacement parts, so that almost any trouble or repair that you can think of can be undertaken on the spot. The same organization also found it advisable and profitable to equip each man with large "prayer" cloths, often bearing the organization's trademark stencilled on them. These protective cloths are spread on the customer's floor. They are large and heavy enough so the flooring, rugs, or carpets cannot be damaged while repair work is proceeding.

It then becomes a simple matter to work on the floor, spread out all the equipment, tools, and parts, take out the chassis, and service the set exactly as the technician would do in his shop.

After the receiver has been tested and reassembled and all the tools and parts put away in their cases, the cloth can be rolled up without dropping anything on the customer's floor. It can be cleaned after the return to the service truck.

All this makes a hit with the set owner who is impressed by such routine, and it also brings repeat business in due time, should the receiver go out of order again.

We have been preaching for years that the day of the untidy and careless technician is over. Today people who have good homes want service with a capital "S". They frown upon anything that is not shipshape and upon any sloppiness or "service methods" which are apt to mar the floors, rugs, and furniture. The customer will not object to pay a little more for up-to-date business-like servicing, because he can see that it is not just haphazard tinkering, but well-planned, serious work.

Usually the better servicing outfits have uniformed technicians who are neat and efficient and inspire confidence. Such men will always be in demand.

The strange part is that modern, business-like servicing is hardly more expensive than the inexpert, haphazard type. A few dollars expended for large floor servicing cloths will be repaid a hundred-fold by additional business and better prices for servicing. *Neatness is always cheaper in the end*—the unkempt, grimy service technician is usually more expensive to himself, believe it or not.

Granted that the best electronic servicing equipment is not cheap. On the other hand, it must be realized, as we have said so often before, that the service technician has only *one* valuable commodity to sell—*his time*. He cannot possibly stretch the hours but *he can make many more calls if he services the television receiver on the spot*. The time consumed in transporting a heavy set to the shop and lugging it back again is *time lost forever*. Besides, the effort and the time loss is useless and costly. If you calculate all the hours it takes during one year to transport radio and television receivers from owner to shop and back, and then compute your time at so much per hour, it will be seen that for this money you can obtain an extensive array of electronic servicing equipment. This is a wise investment that will pay for itself over and over, often even in a single year. Moreover, you do not buy servicing equipment every year, either; such equipment lasts a long time. From this it will be seen that in the end it is much cheaper to invest in worthwhile equipment.

We admit that it is not possible to service all television receiver defects on the spot. But the percentage of sets that must be transported is small and will become smaller as time goes on. While it may not always be possible to carry with you all replacement parts—such as, for instance, picture tubes—it is much easier, cheaper and quicker to go to the shop and pick them up than transport the whole cumbersome receiver twice.



RECENTLY a service technician wrote a letter which asked, in part: "Suppose a fire in my store destroys TV and radio sets which I have taken from customers' homes for repair? Am I liable for the value of these sets to the owners? What if a burglar breaks into my store at night and steals sets belonging to customers? Am I liable? Here's another problem: In a number of cases television service companies have taken large numbers of contracts at approximately \$80 per year, and have gone bankrupt within the next few months. The unfortunate radio owner who has let his televiser be taken for repairs hears that his service company has gone broke over the weekend; he goes down to the now bankrupt shop and finds that his set has been cannibalized to repair others of the same model, and that he has neither contract nor working receiver. Sometimes he doesn't even find any part of his set. What can a reputable technician do to overcome this bad situation?"

Avoid being negligent

Higher courts consistently hold that a service technician never is liable for

*Attorney at Law, Cincinnati, Ohio

When is the technician

Are you liable if a burglar breaks into your shop and steals the sets left there for repair? How about fire, windstorm, accident? This article tells when you are and when you are not liable.

By LEO T. PARKER*

fire loss, theft, or other damage to a TV or radio set left in his shop if the testimony shows that the loss *did not* result from his negligence.

Here's the legal rule for determining whether a service technician is "negligent": Did the service technician, and his employees, exercise the *same* degree of care to safeguard the sets as would have been used by other reasonably prudent owners of service stores under the *identical* circumstances? If the answer is yes, the service technician was *not* negligent and therefore is not liable for the injury or loss to sets in his store and owned by customers.

In the case of *Reimers v. Peterson*, 22 N. W. (2d) 817, the owner of a set had left it in a service shop which burned one night. The set was destroyed and its owner sued the service shop owner for damages.

Since the owner of the set failed to convince the court that the fire started as a result of negligence of the service shop owner or his employees, the higher court refused to hold the latter liable for the loss. The court said:

"Defendant (service shop owner) was not an insurer, and it then becomes incumbent on the bailor (set owner) to show that the bailee's (service shop owner's) want of care co-operated with the destroying cause."

However, an important point of the law is that a service technician cannot be relieved from liability for theft, fire loss, or damage to sets belonging to

customers where such loss does result from *negligence* of the service technician, even though signs are posted reading: "Not Responsible For Loss of Merchandise or Sets Left In Our Care."

The law in this case agrees with common sense and holds that a shop owner or employee cannot evade his obligation to use ordinary care and good workmanship.

Technician's legal duty

Generally speaking, a service technician or owner of shop in which sets are left for repairs must exercise ordinary care by employing trustworthy help and otherwise providing for the safekeeping of sets left in his charge.

On the other hand, a shop owner is not an insurer of TV and radio sets stolen from the shop when there has been no negligence on the proprietor's part. This rule applies even should a thief be an employee of the person operating the shop, provided the theft occurs without the connivance or negligence of the shop owner.

If proof establishes that a set was taken out of a shop and used by an employee, without the knowledge or consent of the proprietor or service technician, such proof, standing alone and unexplained, is not sufficient to make out a *prima facie* case for recovery of damages by the owner of the set. The same law applies with respect to other articles which may be stolen

LIABLE?

from the repair shop. (155 N. E. 533)

Hence a service technician is *not* liable for any loss or injury to radios or TV sets which could *not* have been avoided by exercise of such care as would have been exercised by other "reasonably" careful and experienced servicemen. On the other hand, courts have held that if a service technician keeps an employee who has stolen radios or equipment in the past, he as such *employer* is liable for theft losses, although no direct proof need be given that this particular employee stole the radio or TV set in controversy.

How about a fire?

It is certain that if a fire destroys a service shop containing customers' radios and TV sets the owner of the service shop is *not* liable, unless the owners of the sets prove to the court that the fire started through negligence of the shop owner. Such a situation may arise if the testimony shows that the proprietor of the shop carelessly permitted dangerous combustible materials to lie around.

In one case testimony showed that the proprietor left benzine in an open container in his shop. An employee ignited the benzine by smoking a cigarette. The fire destroyed the customers' sets and also spread to an adjoining building.

The higher court held the proprietor of the radio and TV service shop liable for value of destroyed sets belonging

to his customers, and also for damage to the other building.

A recent higher court explained the circumstances under which the owner of a service shop is *not* liable for loss of customers' radio and TV sets. This court said:

"A shopkeeper is *not* liable as an insurer of the automobile left in his possession *unless he makes himself so by the terms of his contract*, nor for loss of or injury to the goods due to an act of God or of the public enemy, nor for losses due to inherent defects in the goods or other cases not due to negligence on his part. He is required to exercise ordinary care, *by which is meant that degree of care which ordinarily prudent owners of similar businesses are accustomed to exercise under like circumstances.*"

Reducing liability by contract

Contrary to common opinion, the owner of a service shop may not by an ordinary contract *reduce* his legal liability for loss or injury to sets, where the loss results from his or his employee's negligence.

Posted signs, such as "Not responsible for loss or damage to radio and TV sets," have little or no effect to reduce or eliminate the common law liability.

For instance, in the recent leading case of *Langford v. Nevin*, 298 S. W. 536, it was disclosed that a proprietor conspicuously displayed signs: "Not



The service technician being threatened is our veteran author, Homer Davidson.

responsible for loss in case of fire or theft."

When the sets were stolen the owner filed suit against the proprietor to recover damages. The latter attempted to avoid liability on the grounds that the owner had read the above-mentioned signs.

However, the court held the proprietor liable to the owners because the testimony proved that the theft resulted through negligence of the service technician in leaving his shop unlocked. The court stated applicable law as follows:

"The language of the posted signs in question here does not in express terms provide for the exemption of the bailee (shop owner) from the obligation to exercise ordinary care to prevent the theft . . . In cases of bailment having the general aspects of this one, a contract provision, which purports to exempt the shop owner from liability for loss due to particular causes, does not in any respect exempt him from the implied obligation of ordinary care which his relation to the bailed property, as bailee for hire, imposes upon him."

Degree of responsibility

It is important to know that a contract is valid by which a shop owner agrees to exercise a higher degree than ordinary care, or he may contract to be responsible for loss or damage occasioned by any and all circumstances. In such an instance, the contract is valid because the customer is *not deprived* of his legal rights, whereas an ordinary contract relieving a shop owner of liability for damages resulting from his negligence is *against public policy* and *void*.

However, a contract is valid and enforceable if by its terms a shop owner agrees to *lower* the service charges in consideration of a customer reducing the shop owner's liability. A contract of this nature is not against public policy, because the customer impliedly agrees to assume a greater risk for the savings resulting from the decreased charge.

Of course, the amount of the reduction of the service rates must be sufficient to reasonably justify the customer assuming the increased risk of loss or damage to his property. In other words, the courts look through the obscurities of contracts of this nature which are devised merely to relieve the shopkeeper of liability without honest intentions of saving the patron a reasonable and substantial sum for assuming the increased risks.

Acts of God

All courts agree that a service technician *never* is liable for loss or damage to merchandise or sets wholly caused by an act of God.

An act of God is defined by the courts as the result of an irresistible physical force, such as lightning, storm, rain, earthquake, etc., *not* caused by man, and which is not preventable by human foresight.

A court recently stated that whether or not the owner of merchandise or sets left in the care of a service technician may recover damages depends upon whether the loss resulted from an act of God or the act of a human being for whose negligence the service technician is responsible. For example, if the service technician leaves a valuable TV set in such location that it is damaged by a leak through a roof, he cannot avoid liability by pleading that an act of God caused the damage. This is true because a service technician is required to use reasonable prudence to foresee natural results which may arise. However, if lightning strikes the building and it burns, the service technician is not liable for any loss resulting to his customer's sets in the building.

Insurance policies

It is well-established law that an insurance company is not responsible for statements or promises made by ordinary insurance agents, if the service technician fails to read the policy and complain to the company *promptly* that the policy does not afford the protection promised by the agent.

Be warned now that insurance policies do not protect equipment and sets owned by customers if the policy contains a clause which exempts property "in charge of" the proprietor or shop.

For example, in *Guidici v. Pacific Company*, 179 Pac. (2d) 337, the testimony showed these facts: The owner, named Palm, left his set in a service shop for repairs. A mechanic through negligence damaged the set by fire. The proprietor of the store held an insurance policy which contained a clause stating that the policy did *not* cover property of others when rented to, leased to, in charge of, or transported by the proprietor. The higher court upheld the insurance company in refusing to pay the loss.

Many service technicians and owners of service stores pay insurance premiums without knowing that actually they are not protected at all. (Moral: Read your insurance policies.)

In the case of *Milton Company, Inc., v. Travelers Indemnity Company*, 71 N. E. (2d) 232, it was shown that the Milton Company held a burglary insurance policy. A burglary loss was discovered on the morning of December 30. The company's officials neglected until February 10 to notify the insurance company of its loss. (An insurance company requires that notification of loss be filed "as soon as practicable" after the loss is discovered.) By the time inventory could be taken and sworn "proofs of loss" filed, more than two months had elapsed.

The insurance company refused to pay the loss and directed the attention of the Milton Company's officials to the following clause in the policy: "Affirmative proof of loss under oath shall be furnished to the company within sixty days from the date of the discovery of the loss."

The company filed suit, but the higher court refused to hold the insurance company liable, saying:

"It is established law that the failure to file the required proofs of loss within the time limit bars recovery unless the failure is excused or unless it has been waived."

Relationship

All service technicians and proprietors of service shops should know that the legal relation between a service technician and customer is that of *bailor* and *bailee*. As previously explained, the service technician is not liable, for loss or damage unless the loss resulted from his negligence. Therefore if the customer wishes to recover from the service technician for the loss of or damage to his set, he must prove that the service technician or his employees failed to use an "ordinary" degree of care to protect same against loss or damage.

However, this law does not apply to a service technician who agrees to care for merchandise or sets belonging to any person not a customer. If a service technician agrees to keep another person's property without compensation, he is a "gratuitous" bailee who is liable for loss or injury to the articles *only* where he positively is grossly negligent.

Therefore, there is a fine line of distinction between a degree of care required of a paid bailee and a gratuitous bailee.

For example, in a recent case, *Sanders*, 286 S. W. 926, it was shown that a thief stole merchandise from a store, including a radio which had been left with the proprietor by its owner. The owner instituted legal proceedings against the store owner to recover damages.

The court held the store owner *not* liable since the testimony proved that the owner of the set had left it with the store owner for safekeeping only. Therefore, it is quite apparent that a service technician is legally expected by law to exercise only a *slight* degree of care in safeguarding TV and radio sets against injury or loss, *where he receives no remuneration*.

May furnish bond

Reliable service technicians and proprietors of service shops may very successfully combat the effects of bad experiences of customers whose sets have been cannibalized, or who have paid for a year's service only to later learn that the service company is bankrupt and has discontinued business. This result may be attained by having a bonding company issue a bond which guarantees fulfillment of the service technician's or shop owner's contracts. The possessor of such a bond not only may display it in his shop, but also may inform of it in his advertisements. A bond of this nature absolutely protects customers.

—end—

FREQUENCY METER

Reads directly
from zero to
50,000 cycles

By H. O. MAXWELL



SOME time ago, we began a series of experiments to determine the relative stability of various self-excited oscillators and the effectiveness of different types of reactance modulators to be used in a.f.c. circuits and TV sweep generators. To measure frequency drift and deviation under modulation, we used a BC-221 frequency meter, an oscilloscope, and a communications receiver. The oscillator and BC-221 signals were tuned in the receiver and the audio heterodyne output was fed into the vertical amplifier of the scope. Changes in oscillator frequency caused a change in the number of cycles which appeared on the scope.

We soon found this system too slow for accurate measurements. Furthermore, measurements were affected by instability in the receiver and scope. In looking for a faster and more accurate method of measuring the instantaneous frequency of an oscillator, we decided to try a direct-reading frequency meter.

This frequency meter, covering from zero to 50,000 cycles, was developed from a basic circuit (featuring charging capacitors, diodes, meter, and shunt resistor) which appeared in the January, 1945, issue of *Electronics* magazine. The complete frequency meter circuit is shown in Fig. 1 and the constructional layout in the photos.

Theory of operation

The basic idea of using high speed switches (or square waves) to charge a capacitor and discharging it through a suitable metering circuit may be readily grasped by the following analogy.

In Fig. 2, consider S1 and S2 as commutators on a revolving shaft with S1 being displaced 90 degrees from S2. When the shaft is in the position shown at "a", capacitor C is placed directly across the battery E and the charge on C is the product of voltage and capacitance or $E \times C$. When the shaft revolves

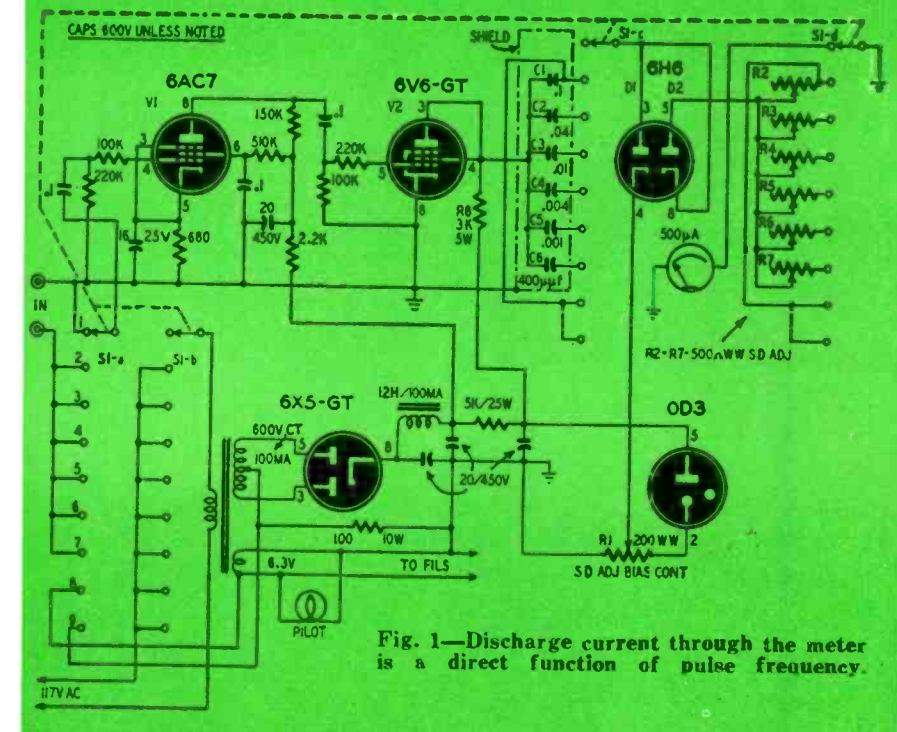

Fig. 1—Discharge current through the meter is a direct function of pulse frequency.

to the position at "b", the capacitor discharges logarithmically through the meter M and resistor R. In this circuit, the average current through the meter is a function of E and C so the current through the meter is limited by the meter resistance and the series resistor R.

Since the resistance in the charging circuit "a" is limited to the internal resistance of the battery—a very low value—the capacitor charges instantaneously. The meter resistance and series resistance R cause C to discharge logarithmically as long as the brushes are on commutator S2. Therefore, the

charge remaining on C at the instant that S2 moves away from its brushes is determined by the speed of the shaft. If the time constant of RC is long compared with the time that the brushes remain on S2, the current through the meter will not drop to zero. Instead, it will read the average of the discharge currents for each pulse applied to C.

The complete circuit

The circuit of the complete instrument is shown in Fig. 1. The 6AC7 and 6V6-GT amplify the incoming signal and produce square waves by grid-cutoff and plate saturation. These

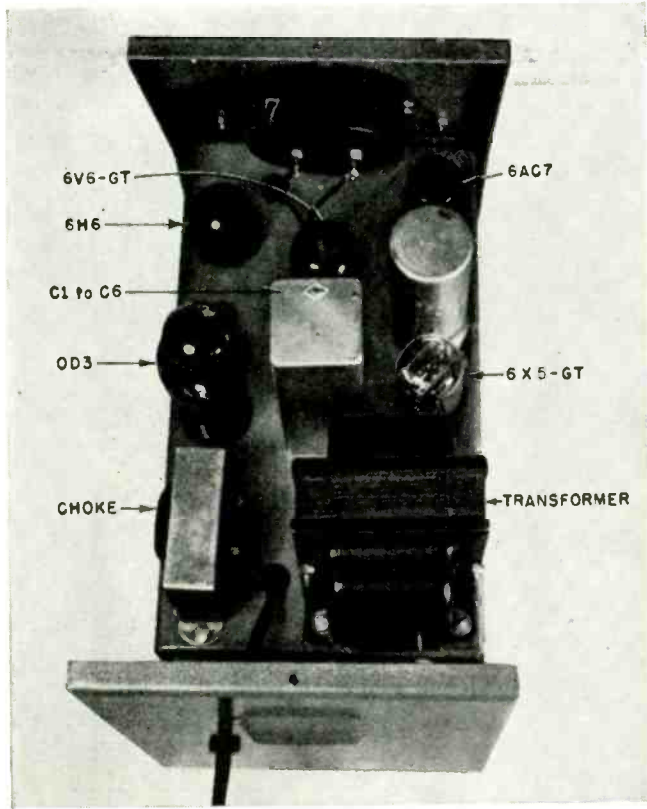

Looking down from the rear of the frequency meter. The sides and top have been removed. Follow the placement of the major components to minimize hum and feedback.

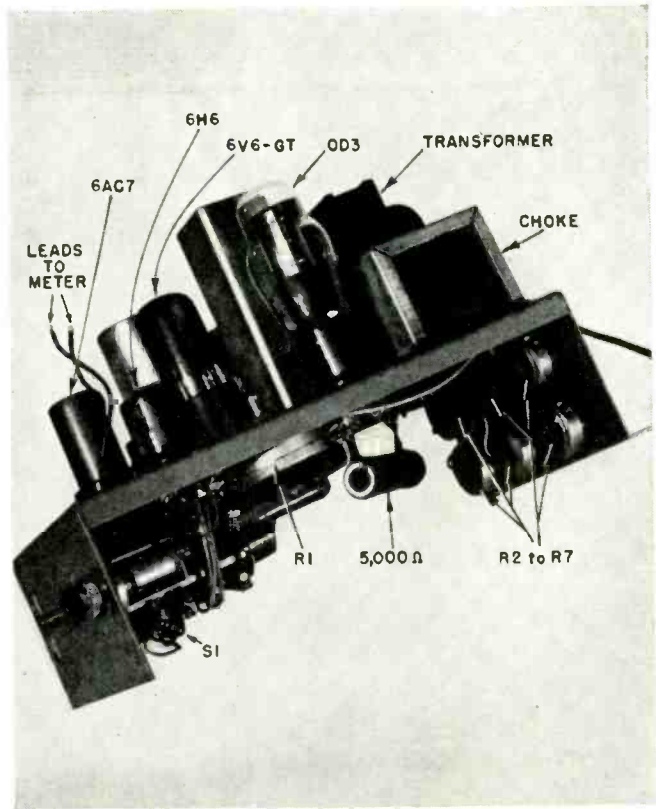

Placement of the under-chassis components is shown in this view. The front lip of the chassis is fastened to the front panel by the pilot lamp assembly and binding post screws.

square waves correspond to the direct-current pulses produced by the commutator S1 in Fig. 2. Patterns 1, 2, 3, 4, and 5 in Fig. 3 show the wave forms at the 6AC7 grid, 6AC7 plate, 6V6-GT grid, 6V6-GT plate, and meter, respectively.

When the output of the 6V6-GT goes positive, the charging capacitor (C1 through C6) charges through diode D1 of the 6H6, R8, and the output impedance of the 6V6-GT stage. Because the time constant of the charging circuit is always much less than one-half the period of the input signal, the capacitor charges to a voltage E_1 which is equal to $E_p - E_b - E_d$

where

E_p = the amplitude of the positive half-cycle,

E_b = the bias on the cathode of D1, and

E_d = the minimum voltage required for conduction in D1.

During the negative half-cycle of the input square wave, the capacitor discharges through D2, the meter M, and the output impedance of V2. The time constant of the discharge circuit is deliberately made much smaller than half the period of the input signal F, so the voltage E_2 which remains on the capacitor at the end of the discharge interval is

$$E_n + E_d$$

where E_n is the amplitude of the negative half-cycle and E_d is the minimum voltage required for conduction in the diode.

The total charge which passes

through the meter is $C(E_1 - E_2)$, therefore the current through the meter for any input frequency F is equal to:

$$FC(E_p - E_n - E_b - 2E_d)$$

Since the 6V6-GT clipper-amplifier and diode D1 are operated from a regulated supply, E_p , E_n , E_b , and E_d are independent of line voltage and the meter current is directly proportional to F and C.

This instrument is operated with one control, a four-circuit, nine-position rotary switch. Section S1-b is in series with the primary of the power transformer. This circuit is closed in all positions except the first—the OFF position.

Section S1-a is in the input circuit. In positions 2 through 7, the control grid of V1 is coupled to the input terminals. When the selector is in positions 8 and 9, 60- and 120-cycle voltages respectively, are tapped off the power supply and fed to the input of V1. These signals are used to check the calibration and to assist in restoring calibration when the 6H6 and OD3 are replaced. Sections S1-c and S1-d switch charging capacitors and meter shunts simultaneously.

Calibration

To calibrate the meter, adjust the bias control R1 so the current through the meter is 500 microamperes at a frequency approximately 60% of the full-scale frequency in any range, then adjust the corresponding meter shunt R2 through R7 for correct calibration. This adjustment is simplified by setting the selector to position 9—the 120-

CYCLE TEST position. Adjust R1 to bring the meter to 500 microamperes and R2 to drop the reading to 300. The remaining ranges are adjusted by feeding in known frequencies and adjusting the shunts for correct readings.

Individual linear scales can be drawn for each range; however, we find it easy to use Table I to interpolate the meter readings in terms of frequency in cycles per second.

Construction

If you guard against stray 60- and 120-cycle pickup from the power supply

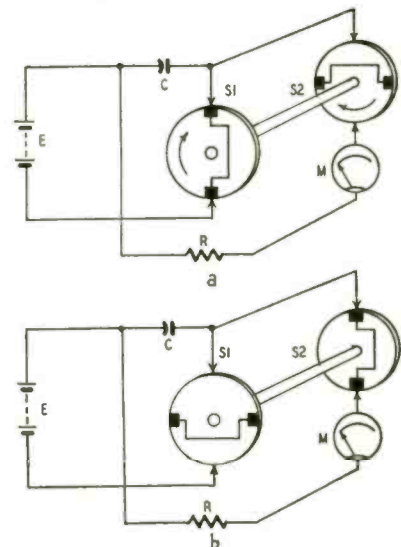

Fig. 2—Electromechanical analogy of the operation of the audio frequency meter.

a 4-tune tuned-radio-frequency kit. That kit took some of the starch out of me when it came. The diagram for assembling it looked like hen tracks. Furthermore, we had no a.c. line on the farm. The equipment the school lent me operated on a 6-volt battery.

I put away my kit and dug into my lessons again. They began to get easier to do and harder to put aside when I would have to go back to bed. I could not yet sit in my wheelchair all day. That little old radio kit never did get assembled, but it was responsible for my first real repair job. Our family radio stopped performing and developed a terrific hum. I didn't make any brags, but, when Mom and Dad were away, I tackled the thing. My two kid brothers gave me a lot of advice and discouragement. I took the electrolytic capacitor out of the kit, and, by sheer luck, bridged it across the old capacitor. The old radio snapped back into action. I knew I was in business then. The kid brothers changed their tune and began to credit me with a little sense; they were as proud as I was. My luck hasn't always been that good; a lot of jobs have taken more time and brain work, but that first real repair job told me I could make my own living! It was a grand feeling.

However, my troubles weren't all over. The lessons could still stop me cold for days. Reading how things worked, sounded, smelled, and tasted was a lot different from the real thing. After that first repair job, though, I never thought of quitting.

Word got around the neighborhood and town that I was a smart hand with a radio, and the neighbors began bringing their ailing sets to the farm. I fixed

house was ready. I was in business every hour I could stay out of bed.

My strength improved and so did my skill and confidence. I was really pulling my own weight. My customers were satisfied, and I was no longer dependent upon my parents. My customers kept insisting that I could fix anything; so, in 1948, I took another correspondence course—one in appliance servicing this time. I became the town fix-it man. So far, I've handled anything and everything in broken gadgets anyone has brought to me.

There are three television sets in town, including my own. I feel that television servicing and I are growing up together here in Puxico. By the time there are TV sets and stations enough to make television really practical here, I should be in on the ground floor. My own set has paid off in the things it has taught me.

I haven't invested too much in tools and equipment for my shop because I've built most of it from kits. It's cheaper like that and pays off two ways; I get the equipment and also the know-how gained from building it. This gives me tools sufficiently accurate for my requirements and allows me to have more than I could otherwise afford.

In some ways, my old wheelchair has helped business. People here have more time to bring in their repair jobs after work, and I'm always on hand then. I'm not likely to be out loafing; so I get busy on jobs as they come in. I try to keep my reputation as a fast repair man. I'm still in business, self-supporting, and learning more and more all the time.

—end—

form at its best. The Little Woman gave her blessing to the project, since she had always complained of having to readjust our indoor antenna each time she switched channels.

We bought a double-V and prepared to install it. Recalling that most of the neighbors can't get channel 13, and that the service contractors have stated that the ghosts and snow are common to our neighborhood, we determined to find out how this tied in with the installation methods. The first step was to survey our roof with the "Roof-Top Televiser" (RADIO-ELECTRONICS, October, 1949).

No particularly hot spots were found but we were startled to find that the average signals were stronger on all channels when the antenna was oriented about 75 degrees off the line of the others on adjacent roofs. Tuning the televiser to channel 13, we found that the test pattern of WATV compared favorably with those of WCBS and WNBT on channels 2 and 4, respectively. The final installation was oriented toward the more distant WATV and WOR, and resulted in excellent reception from these, as well as the Empire State Building stations.

Since our installation and tests prove that it is possible to get good signals on *all* local channels, we wonder why many service contractors do not instruct their men in orientation techniques and supply them with signal field-strength meters, telephones, or other devices needed for a good installation. Certainly the expense of call-backs, answering complaints, etc. must exceed the initial cost of the instruction and equipment required.—R. F. S.

Convenience the Keynote

By C. R. ASKEY*

WE drew up the plans for this after a careful study of the good and bad features of service benches. One of the bad features noted in all benches was the lack of provision for holding the schematic diagram of the set under repair. Usually it is placed on top of the bench (taking up valuable working space) or spread out on another bench somewhere in the shop, or even held in the technician's lap. A pull-shelf has been built into this bench for diagrams or service manuals. It is located over the top left-hand drawer; it is 17 inches wide, and will pull out a full 30 inches.

Servicing an individual test instrument when several are built into a single panel is inconvenient, and the whole bench is tied up until the repairs have been completed. Individual panels are provided for all built-in instruments on this bench. This system of mounting test equipment eliminates the expense and time of installing a complete new panel if instruments of different dimensions are later used instead of the original ones.

Oscilloscopes usually take up a large part of the bench's working area, as the shelves of the instrument panel are

seldom deep enough to hold the average scope. By building the top shelf 18 inches deep, plenty of room is provided for most oscilloscopes. (The lower shelf and sides of the instrument panel are only 15 inches deep, giving the bench top three additional inches of depth. Most service benches are short on a.c. outlets. It is often necessary to disconnect some piece of test equipment—or even the soldering iron—to plug in a set to be checked. All foreseeable future requirements in this respect have been taken care of by providing 20 a.c. outlets behind the instrument panel, plus one duplex outlet each from the Variac and isolation transformer, and five duplex outlets for plugging in sets, the soldering gun, and portable test equipment. One additional duplex outlet with its separate on-off switch is mounted under the bench for the vacuum cleaner. This adds up to a grand total of 36 outlets. Some technicians might consider this excessive—but so far no one using this bench has griped about not having enough a.c. outlets!

A vacuum cleaner is mounted out of the way under the bench, with the hose in an easily reached position.

The bench top, which is covered with

$\frac{1}{8}$ -inch tempered Masonite, measures 42 x 72 inches, leaving a 27 x 72 inches clear working surface, after allowing for the instrument panel. This gives ample room for TV work, while leaving the instruments within easy reach.

Two cabinets are located under the bench, each containing two 5 x 17 x 30-inch drawers, plus a 17 x 17 x 30-inch storage bin.

The legs and instrument panel are fastened to the top of the bench with wood screws. The drawer cabinets are likewise secured to the legs, which allows the entire unit to be disassembled in a few minutes if it must be moved through a narrow doorway.

A duplicate set of tools similar to the ones shown mounted in the tool box cover are available in the top right-hand drawer. The tool box and portable meter are used on outside calls.

The top shelf of the instrument panel contains the following: capacitor checker, TV alignment generator, oscilloscope, v.t.v.m. audio sine and square wave generator, and cross-bar TV generator. The lower shelf contains a combination TV marker and standard signal generator, signal tracer, 6-volt d.c. power supply, a.c. power panel, resistor

*Tampa, Florida

RECENTLY a number of the larger television manufacturers agreed to install highpass filters in receivers already sold by them, if they are subject to certain types of interference. These filters are to be installed at no cost to the set owner, but it is stipulated that the interference must take place during operation of a licensed amateur station, and must be due to insufficient intermediate frequency rejection by the receiver's front end.

It is encouraging indeed to see that the manufacturers are beginning to recognize what is probably the most important cause of TVI complaints: insufficient i.f. rejection. Nearly every television owner at one time or another has had his reception ruined by this type of interference. When it occurs, the viewer cannot switch to another program, because the interference is equally bad on *all* channels.

Television interference may be on three frequencies (in present-day superheterodyne TV receivers). These are the real frequency (that to which the receiver is tuned), the image frequency, and the intermediate frequency. Any interfering signal of the frequency to which the set is tuned will cause interference which can be suppressed only at the source. The image and intermediate frequencies are problems for the receiver manufacturer.

Considering reception on all channels and interference on a percentage basis, the interference due to inadequate i.f. rejection will be far greater than that due to inadequate image rejection. The chief victims of this receiver design defect are the licensed amateurs and physicians and hospitals operating FCC type-approved diathermy. Indeed, it is surprising that the agreement referred to at the beginning of this article men-

tions only amateur interference. It would be of much greater service to the television-viewing public if it included *any television interference due to insufficient i.f. rejection, regardless of the source of the interfering energy.*

The doctors' dilemma

The diathermy-using doctor is in a particularly bad situation, since he finds that in changing over from obsolete and no longer legal apparatus to the new FCC type-approved equipment (which operates on a frequency of 27.12 mc) he apparently creates much worse interference. In one case, the physician—on the advice of his service technician—directed the distributor from whom he had bought his type-approved diathermy equipment to take it back.

Naturally, the distributor informed the New York FCC office. The doctor's position was clear: "I am not one of those persons who want to operate on a particular frequency," he stated. "All I want is diathermy. I ordered equipment supposed to work according to FCC regulations, and my neighbors tell me that instead of interfering occasionally on channel 2, I am ruining *all* their TV programs! Now I am just a physician. I don't intend to take a post-graduate course in electronics and diplomacy when I am operating equipment in compliance with FCC rules and regulation."

The doctor's situation is a serious one. He may be assured that his equipment is in good order and operating correctly. Yet he realizes that the bad feeling created by breaking up his neighbors' television programs can do him harm professionally and socially. His older equipment, operating in the region of 30 mc, created severe interference on channel 2 (second harmonic of 30 mc), but little or none on other channels. It was far enough in frequency from most television i.f.'s to

cause no i.f. interference. But his new 27.12-mc equipment rides through on all 25-mc i.f. receivers which do not have good i.f. rejection.

The amateur operator

The licensed amateur finds himself in the same predicament. He too is operating equipment which must meet FCC specifications. Most amateurs have accepted the challenge of television and have made an honest and sincere effort to resolve the problem. A great many amateur clubs have formed committees to assist the service technician and the televiewing public to clear up the confusion associated with certain types of television interference. The "Dallas Plan" in which a committee formed by amateurs, service technicians and representatives of television set manufacturers or dealers cooperate in these efforts, is especially worth mention. Originated by amateurs of Dallas, Texas, it is spreading to other cities throughout the country, with the encouragement of the FCC.

The amateurs have been doing this work on their own time and at their own expense. But at this point it might be well to remember that there are limits to the patience of a neighborly amateur or a good doctor. When an amateur demonstrates that he can operate his transmitter without interfering with a television receiver *in the same room* it is ridiculous for the service technician to advise a television owner down the block that the fault is with the amateur transmitter. The same goes for type-approved diathermy. In such cases the fault is solely with the receiver, and this fact should be made known to the public. The problem cannot be solved amicably without the cooperation of the manufacturer and service technician and unless the television set owner thoroughly understands the situation.

*Radio Engineer, FCC, New York City.

the two lines wired in place (Fig. 6).

In performance the rhombic gives the greatest gain of all devices tried, but its high directivity narrows its use. It was beamed particularly for chan-

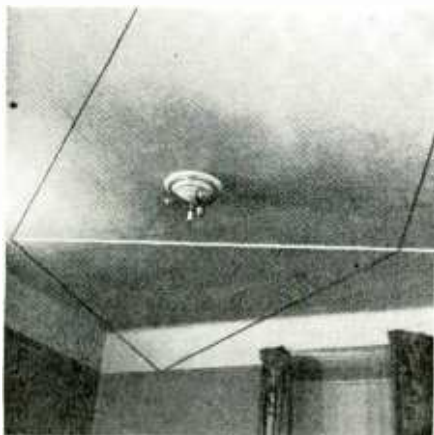

Fig. 6—The directive rhombic antenna.

nels 4 and 7 which were already located on the Empire State Building.

The search for channel 11 continued. A simple dipole cut for the high band was constructed. Two sections of flat curtain rod were cut to 14 inches length and mounted on a lucite separator for this antenna. Then the dipole was mounted on the mop handle, and search begun. This probing revealed a very strong area right in the center of the bedroom door, showing that v.h.f. waves are no respectors of persons. An equally good spot was finally located at the top of a small hall with the dipole diagonally away from the wall (Fig. 7). A wire bracket was constructed to hold the dipole, and the position was carefully checked for minimum ghost on the TV screen. Adjustment was very critical but highly successful.

With three separate fixed antennas, each highly effective on specific channels, the lead back to the set was sim-

is used to match this line close to the set. Match was made for maximum gain on channel 11, the goal of the long search.

Just to show that there may be many a slip twixt the TV set and the antenna:

One phenomenon was very puzzling for a while. Ghosts would appear when the TV set was returned to the living room after working perfectly when close to the fixed antennas. These were found to be originating in the long lead from the bedroom hall and were due to the lie of the line. They were worked out, again by using the TV screen as monitor. Changing the position of the line a few inches here and there along the wall near the set cancelled the ghosts.

And this is the moral

What all this proves is that somewhere in the house there are clear signals waiting to serve you with good TV reception. If you are haunted with ghost images, take another look. A properly matched line, a good antenna system—plus plenty of patience—will exorcise your haunts!

—end—

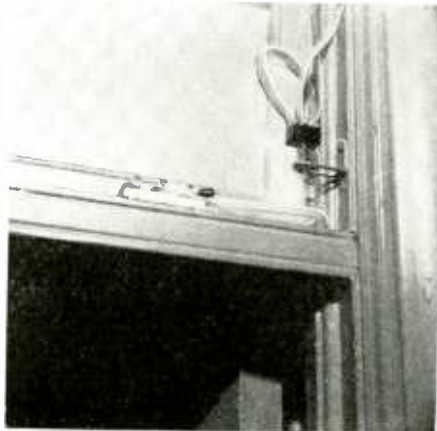

Fig. 8—Switch for the bedroom network.

weather conditions will bring signals up nearly to the best summertime levels, but the in-between periods will be characterized by poorer reception than at any other season of the year. During the odd periods of good sporadic-E dx more and more reports of co-channel interference have been coming in from the field. This takes the form of shadowy figures and squares drifting across the picture of a local station. It is usually associated with sensitive TV sets operating with efficient antennas. The service technician is often obliged to reduce the signal input to the set to lessen the local interference.

The variations in fringe-area reception associated with weather changes will be easy to anticipate for two to three days in advance. Signals will be at their lowest levels in the cold windy weather that is often encountered at the start of a cold wave. They will be at their best as a period of fair cold weather begins to moderate, and sleet, rain, or freezing rain is in prospect. It is at this season that the effects of weather on v.h.f. propagation are most clearly defined, and the late winter and early spring make a good period for the dx enthusiast to develop his weather and propagation know-how.

February is a prime month for aurora borealis observation, particularly in the more northerly portions of the country. Some of the most pronounced ionospheric disturbances ever recorded have occurred in the latter part of February. To observe the effects of aurora on TV reception you need a rotator, if your array is not already aimed in a northerly direction. This is a phase of wave propagation that is still little understood. Observers can help to advance our knowledge by keeping a close watch on TV reception during aurora periods and reporting their results in detail.

—end—

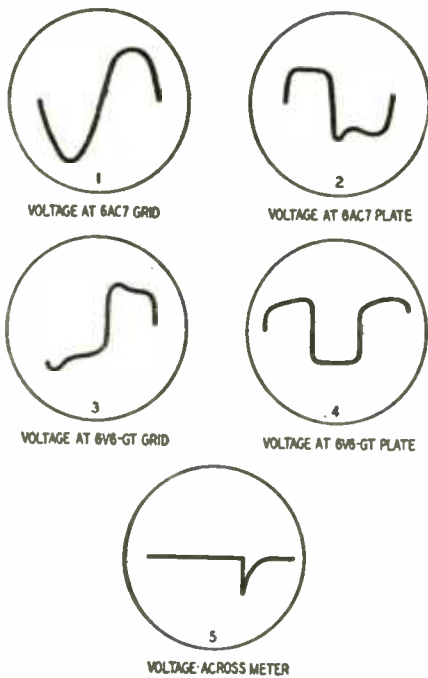

Fig. 3—Oscilloscope patterns showing the waveforms present at various sections of the circuit. Note that the polarity of the trace depends on the number of stages in the scope. The upper and lower halves of the trace may be shifted right and left by varying the phasing and fine sweep-frequency controls.

the instrument will be as easy to construct and place in operation as a simple audio amplifier. The power transformer and filter choke are at the rear of the chassis, well removed from the input terminals. The charging capacitors C1 through C6 were originally placed directly on a section of the switch. Here, they picked up hum voltages and caused feedback between input and output circuits. This difficulty was eliminated by wiring the capacitors together, fitting them with color-coded leads, and mounting them in a National type RZ coil shield. With this change, the instrument became absolutely reliable on all ranges, and performed well on all input voltages ranging from .05 to 300 volts r.m.s.

This unit may be constructed on any convenient chassis; however, if you wish to duplicate this cabinet and chassis, the construction details are shown in Fig. 4. Your local tinsmith can do the job for a few dollars. If he does not have the equipment for punching the ventilating louvres, you can have him cut a suitable slot so you can insert ready-made louvres. Or you can build the device to fit in a case you may have

handy. Slight changes in layout should not affect the performance noticeably, especially if they are not in the direction of making the unit smaller.

Operating the meter

This audio frequency meter having only one control and one set of input terminals, non-technical personnel find it much simpler to operate than the average multimeter. Normal variations in line voltage do not effect the accuracy of performance of the instrument because the critical voltages are stabilized by the 0D3 voltage regulator tube. Signal voltages may vary from below 1 volt to above 300 volts without affecting accuracy.

To use, simply connect the input terminals to the signal source through shielded cable. Be sure that the braid connects to the grounded terminal of the meter. Rotate the selector switch on the panel until the needle comes to rest.

If the indication is in the lower one-quarter of the scale, switch to a lower range which brings the needle into the upper half of the scale. Calibrate the meter directly or interpolate the frequency by using Table I.

We wish to acknowledge the invaluable aid of Donald St. Clair who designed and constructed this frequency meter from the basic counting circuit.

Materials for Frequency Meter

Resistors: 1—200 ohm and 6—500 ohm, wire-wound potentiometers with slotted shafts; 1—680, 1—2,200, 2—100,000, 1—150,000, 2—220,000, 1—510,000 ohms, 1/2 watt or larger; 1—3,000 ohms, 5 watts; 1—100 ohms, 10 watts; 1—5,000 ohms, 25 watts.

Capacitors: 1—.0004, 1—.001, 1—.004, 1—.01, 1—.04, 4—.01 μf, 600 volts, paper; 1—16 μf, 25 volts; 4—20 μf, 450 volts, electrolytic.

Miscellaneous: 1—rotary switch, 4 poles, 9 positions; 2—terminal assembly (National type FWH or equivalent); 1—coil shield (National type RZ or equivalent); 1—meter, 500 μa d.c.; 1—choke, 12 henries, 100 ma; 1—power transformer, 300-0-300 v.a.c., 100 ma, 6.3 volts, 3 amp; 1—6AC7, 1—6H6, 1—6V6-GT, 1—0D3/VR150, 1—6X5-GT tube; sockets, pilot lamp assembly, hookup wire, sockets, terminal strips, hardware, etc.

—end—

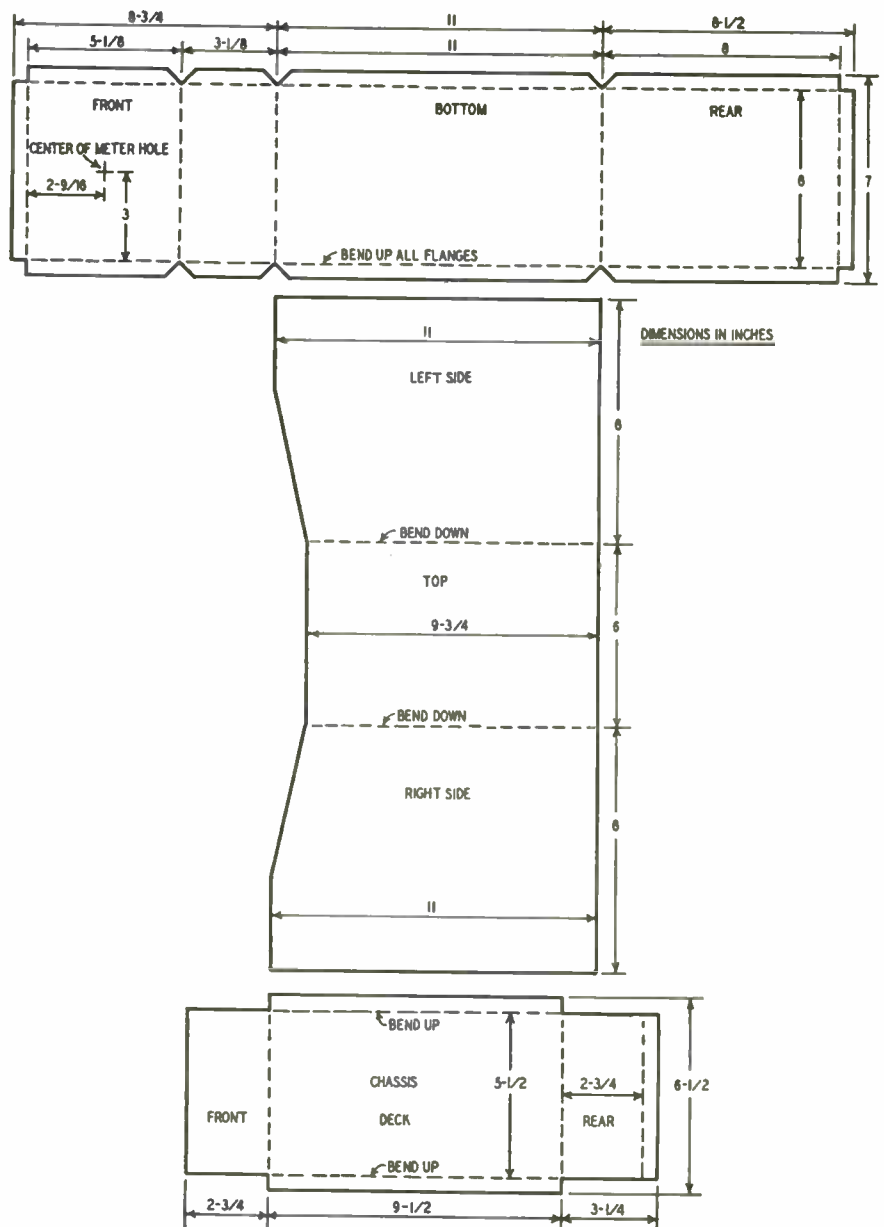

Fig. 4.—Patterns for duplicating the case shown in the photographs. Study all the photographs and the drawings above before starting in to cut or bend the metal.

Table I

Switch position	Range (cycles)	Scale multiplier
1	OFF	OFF
2	0-200	Divide by 2.5
3	0-500	Multiply by 1
4	0-2,000	Multiply by 4
5	0-5,000	Multiply by 10
6	0-20,000	Multiply by 40
7	0-50,000	Multiply by 100
8	60-CYCLE TEST	Divide by 2.5
9	120-CYCLE TEST	Divide by 2.5



The author goes over a 10-inch TV set at his service bench.

Mr. Cookson has proved by his experience that formidable obstacles plus courage and tenacity equal achievement!

WHEELCHAIR SERVICE SHOP

By J. T. COOKSON

MAKE my living repairing and selling radios and electrical appliances. I have a one-man shop in a little town. I make a living for myself, and I have managed to pay some pretty stiff doctor and hospital bills. Lots of fellows have done that; so it's not extraordinary in itself any more than there is anything extraordinary about my shop. The thing that interests people is that I do my work in a wheelchair, when I'm not sitting on the floor wrestling the innards out of a big cabinet model.

I learned my trade while flat on my back. That was not the half of it. I had to figure out things strictly on my own. You see, in Puxico, Missouri—that's my town—there are fewer than eight hundred people, and advanced technical electronic know-how is sort of scarce. I lived in the country then, so experts didn't happen along very often. When my brain was too fuzzy to see through a problem, my hands had to work it out.

I always had most of my brains in my hands, anyway. When I was a boy, motors, clocks, cars, and radios were the things I liked best. When I was a high school freshman I had a science teacher who let us build electric motors

instead of taking examinations. When I was learning about radios the hard way, I blessed that teacher.

But, to get back to the beginning, I might never have been in this business if I hadn't come to the wheelchair stage. Back in 1944 I was a junior in high school, and when anyone asked me of my future plans, I said I was headed for the Air Force. Pilot, radioman, mechanic, or whatever, they all looked good to me. A lot of boys felt that way then, and I was going along toward finishing high school and making that try for the Air Force when my ambitions got changed for me, abruptly and permanently. A friend and I got enough rationed gasoline ahead to have a Saturday night date complete with an auto trip out of town. Bad luck caught up with us, and, when the dust had settled, I had been thrown clear of the wrecked car, and something had happened to my legs.

The doctors told my parents I had a bone splinter in my spinal cord, and there was nothing they could do about it. I had walked my last step and there I was. My folks heard that a lot of times before they finally brought me home. They didn't give up easily, but

finally they had to. I was seventeen, with not much future before me. I had a pair of hands that liked to make things work and three years of high school education.

I was hurt in the spring, just before the end of the school year. By the following fall, I had decided one thing. I wanted my high school diploma. I wanted to graduate with my class. Some of my teachers were not so enthusiastic about that idea of mine. It's a small school, and the teachers knew their students pretty well. I guess they knew I hadn't ever been the quiz-kid type. They were afraid I would get discouraged trying to do senior work by myself. As I said, our school is a small one and doesn't have such services as home tutoring for handicapped pupils. I would have to do the job on my own. They did their best for me, though. I got that diploma, and I learned more that year than any year of my school life.

While I was still finishing my high school work, a Raleigh salesman called on my mother with his line of condiments and flavorings. He found that I liked radios and mechanics in general and promised to bring me a book on

RADIO-ELECTRONICS for

and capacitor substitution panel, 7- and 9-pin miniature tube pin straighteners, a tube tester, crystal-controlled signal generator, and a master circuit-breaker panel.

The master circuit-breaker panel contains a 1-inch pilot light assembly and a 20-ampere switch-type circuit breaker which also serves as an on-off switch for the entire bench.

The a.c. power panel contains a 7.5-ampere switch-type circuit breaker, a 7.5-ampere Variac, a 5-ampere isolation transformer, a 0-500 a.c. wattmeter, a 0-150 a.c. voltmeter, and two duplex a.c. outlets. The Variac feeds one duplex outlet and also the 6-volt d.c. power supply. The isolation transformer feeds the other duplex outlet.

The resistor-capacitor substitution panel contains 10-, 100-, 1,000-, 10,000-, 100,000-ohm, and 1-megohm, 2-watt resistors, and .05-, 0.5-, 8-, 16-, 30-, and 80- μ f, 600-volt capacitors.

The oscilloscope was modified by adding two additional vertical amplifier stages (giving a vertical sensitivity of 0.01 v/inch), a vertical sweep circuit, and a Z amplifier. By applying a video signal to the Z input terminals, and sync voltages to the appropriate inputs, a picture may be viewed on the 'scope tube.

The signal generator was selected with the intention of converting it to serve also as a TV marker generator. The large amount of dial travel makes it ideal for this purpose. An additional band covering 20 to 30 mc was added to the original circuit. It spreads completely across the dial. Another oscillator with a 20-position fixed-frequency selector switch was added, providing fixed frequencies of all the present TV video carriers, plus i.f. frequencies of 4.5, 25.75, 26.1, 26.25, 26.4, and 26.75 mc. Two spare positions are available for future needs. The outputs of the two oscillators may be used together or individually.

Before purchasing the materials for the bench, it is advisable to plan the finished bench around the equipment which you have on hand or plan to purchase in the near future. Arrange and rearrange your equipment to determine which layout is most convenient to use. After settling on the layout, check its dimensions and compare them with those of the bench. Don't forget to leave space for service manuals if you like to have them on the bench where you can get at them without moving. After determining the space you need, it is a simple matter to add a foot or two to the length of the bench. The materials are sufficiently heavy to permit this without complicating the construction. The extra area under the center can be used for storing record changer racks and other bulky items of this type. If the shop is well lighted a single gooseneck lamp may suffice on the bench. However, if the area is fairly dark, it is advisable to install tubular lighting fixtures over those instruments whose dials are often obscured.

—end—

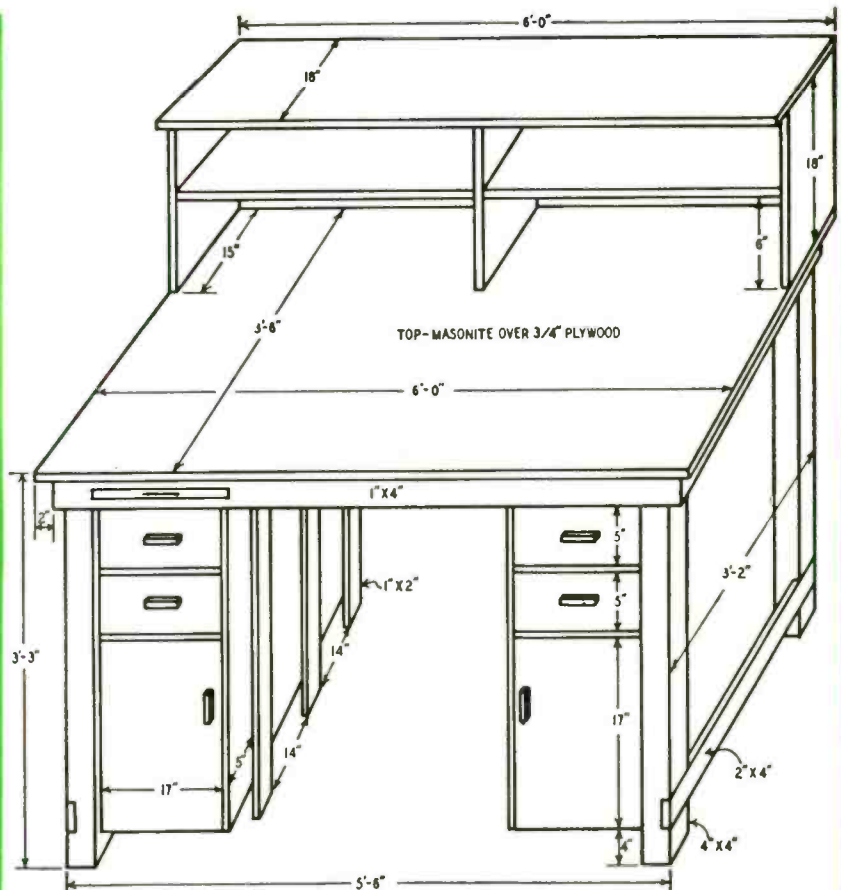

This projection will make it easier for the constructor to visualize the bench.

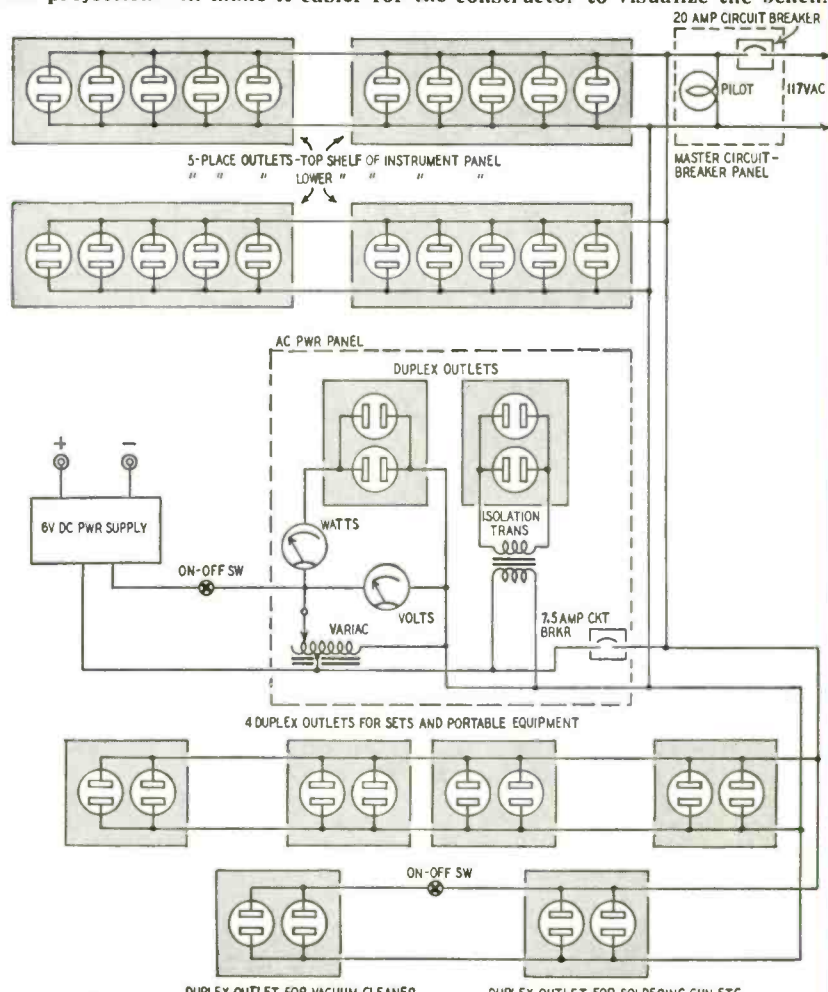

The wiring diagram. Lots of outlets, but who ever complained of too many?

PRACTICAL CODAN CIRCUITS

By RONALD L. IVES

SENSITIVE modern receivers, equipped with automatic volume control, can bring in almost any station on earth, and give about the same audio output for any station, whether it is 1,200 feet or 12,000 miles from the receiver. Many such receivers are advertised to have, and actually attain, "maximum usable sensitivity."

When no carrier is being received by such a "hot" receiver, the a.v.c. voltage is minimum, and the sensitivity maximum. The later stages amplify and deliver through the speaker all the electrical noise produced by the first tube, augmented by miscellaneous random electrical disturbances in the cosmic vicinity of the receiver. Some of these may originate beyond Alpha Centauri.

Because receivers equipped with a.v.c. are most sensitive when no carrier is

Perhaps the simplest codans consist of a triode and a relay. Two similar relay codans, one with fixed adjustments, and the other adjustable, are shown in Fig. 1. Operation is simple. In Fig. 1-a the triode draws enough plate current to operate the relay whenever the a.v.c. voltage is low. When the a.v.c. voltage rises to a sufficiently high (negative) value, the plate current of the tube falls below the drop-out limit of the relay and the contacts open, thus removing the short across the loud speaker.

When the a.v.c. voltage falls to a definite low value, the plate current of the triode rises to the pull-in point of the relay, and the speaker is silenced. Because the pull-in current of a standard relay always exceeds the drop-out current, the "on" and "off" a.v.c. voltages will not be equal.

Minor adjustments of this codan may be made by changing the tension of the relay spring. Major changes can be made by changing the plate voltage, or by substituting a triode with different characteristics. An a.v.c. voltage exceeding about -2 is needed for dependable operation of a codan of this type, constructed with standard radio components throughout.

Circuit of a relay codan in which the operating point can be adjusted within wide limits is shown in Fig. 1-b. Here the control voltage, applied to the grid of the triode, may be varied from zero to maximum by adjustment of the grid potentiometer. This must have a high

value to prevent loading the a.v.c. circuit, with resultant drawdown of the control voltage.

When the grid of the tube is nearly at a.v.c. potential, the codan will be most sensitive to weak signals. When the grid of the triode is at low potential, the codan will be relatively insensitive, so that only strong signals can be tuned in.

With this codan, as with most others, great care must be taken to minimize a.f. in the a.v.c. circuit, or the device will have "temperament," and a zone of uncertainty where only modulation peaks will be heard. The a.f. is best eliminated from the codan line with an additional R-C filter, consisting of a 1-megohm resistor in series with the line and a 0.1- μ f capacitor from grid to cathode of the control tube. This appears to be the optimum value in

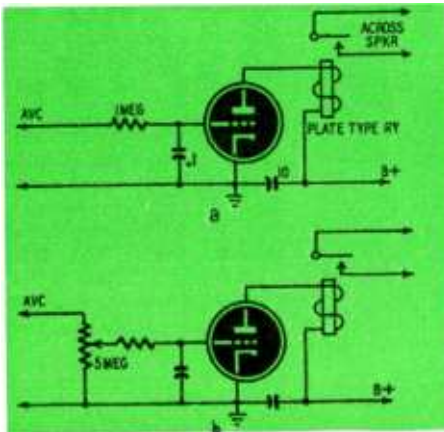

Fig. 1—Relay Codans. Top (a) is a fixed type; lower has an adjustable threshold.

being received, the speaker is not silent when the carrier is interrupted either by cessation of the transmission or by detuning, and the speaker emits, during intervals of no carrier, a high-pitched random noise almost as loud as the signal that was being received. Such noise is irritating to all listeners in the vicinity of the receiver, and produces much auditory fatigue in the operator.

Devices for eliminating such noises, usually known by the generic term CODAN (Carrier operated device, anti-noise), were developed by the Bell Telephone Laboratories almost two decades ago¹, and have been performing satisfactorily in commercial equipment for more than a decade. Terman², of course, also mentions the device.

The ordinary codan is a relatively simple device. It consists of a control tube and a controlled device, such as a relay, a neon bulb or another tube.

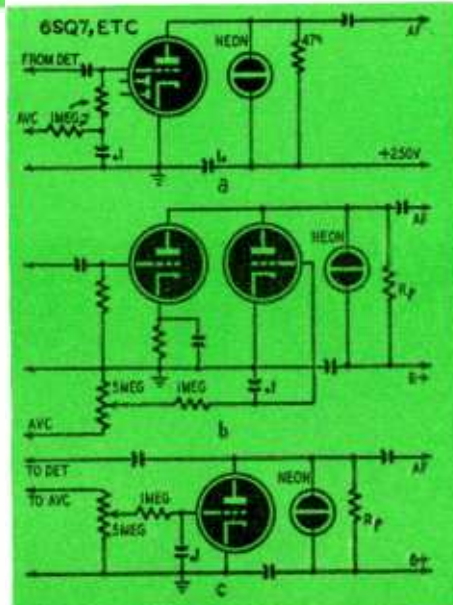

Fig. 2—Codans of the neon-tube type.

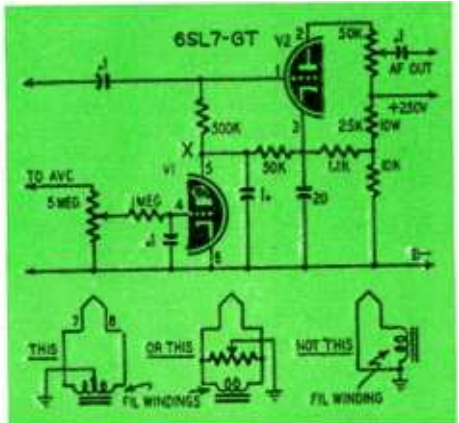

Fig. 3—Circuit of a dual-triode Codan.

most instances, as its time constant ($T = RC$) is 0.1 second, which is approximately the reaction time of the average operator. A smaller filter may pass some a.f.; a larger filter may be "slow," and cause trouble in tuning.

Relay codans are widely used in ship-to-shore radio-wire systems, and in police communications. Their chief disadvantage is that the relay may have contact trouble in salty environments, or where there is much vibration.

Neon-tube codans

Because a neon tube has an almost infinite impedance when the applied voltage is below the striking point, and a very low impedance when the striking voltage has been exceeded, it is possible to use a triode-neon-tube combination as a codan. Three workable circuits are shown in Fig. 2.

The simplest, and least flexible, of these circuits (Fig. 2-a) combines the functions of an a.f. amplifier and the codan control tube in one triode. This codan consists of a one-stage audio amplifier, with the grid return connected (through a filter) to the a.v.c. line, and the plate resistor shunted by a neon tube, such as a NE-48.

In operation, when the a.v.c. voltage is low (below about -1.6 volt with the constants shown), the drop across the plate resistor exceeds the striking voltage of the neon tube. It conducts, shorting the plate to ground for a.f., and no signal is passed on to later a.f. stages.

When the a.v.c. voltage rises, the

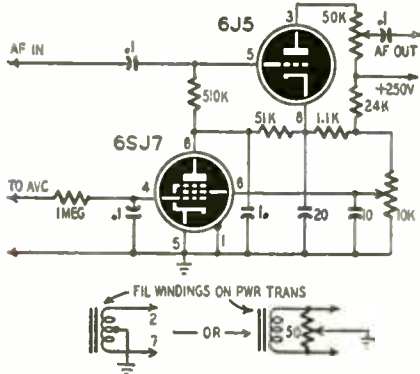

Fig. 4—Codan with pentode and triode.

plate current of the triode decreases, as does also the voltage drop across the plate resistor. When this drop becomes less than the extinction voltage of the neon tube, the tube ceases to conduct, and a.f. is free to go on to later stages. Because the ignition and extinction voltages of a neon tube differ by about 15 volts, the "on" and "off" values of a.v.c. voltage are not the same.

By using a 6AQ7 or similar dual diode triode, it is possible to combine diode detector, a.v.c. rectifier, first audio stage, and codan "all in one bottle," at very low cost. Adjustment of a codan of this type is difficult because of interlocks of functions. If the a.v.c. voltage rises very much above the "on" point of the codan, it tends to cut off the triode, leading to a.f. distortion or elimination of very loud signals.

To reduce interlocks, and to permit some adjustment, the a.f. amplifier and codan control tube can be separated, as in Fig. 2-b. If sufficient a.v.c. voltage is available to cut off the second triode for the weakest desired signal, this circuit is satisfactory, but requires either that the triode draw a rather low plate current, or that the plate resistor, R_p , be rather small. A choke in place of this resistor (to keep the d.c. resistance low while maintaining a high impedance) is not very satisfactory, as the combination of plate choke and neon tube tends to go into vicious oscillation.

It is possible to isolate the amplifier and codan completely, as in Fig. 2-c, so that interlocks between functions are at a minimum. This circuit performs quite well, but requires just as many components as a more satisfactory dual-triode type of codan.

All these neon-tube codans have a

range of tricky operation near the off-on transition point because the voltage across the neon tube consists of two components—a steady d.c. voltage, the drop across the plate resistor; and a fluctuating a.c. component, the signal.

Because of their many limitations and vagaries, neon-tube codans are best suited for use in fixed-tuned point-to-point services, where the signal strength is great and nearly constant. In services of this type, simple neon-tube codans (as in Fig. 2-a) are cheap and very satisfactory. In other services, other types are superior.

Vacuum-tube codans

Inherent limitations of relay and neon-tube codans resulted in the development of a number of types employing only vacuum tubes. Circuit of a highly satisfactory dual-triode codan is shown in Fig. 3.

In this circuit, the plate current of V1 is controlled by the a.v.c. voltage (carefully filtered). When V1 is not cut off, the voltage drop across its plate resistor, which is in series with the grid return of V2, biases V2 to and beyond cutoff, so that it passes no a.f.

When V1 is cut off (by high a.v.c. voltage), it draws no plate current, so that the voltage drop across its plate resistor is zero, and the only bias applied to V2 is produced by its grid circuit resistors. It then amplifies in a normal fashion.

With the constants shown, an a.v.c. voltage of at least -3.5 is needed for satisfactory operation. Filtering to eliminate any a.f. from the codan circuit consists of 1 megohm and 0.1 μ f in the grid circuit of V1, and a 1- μ f capacitor from plate of that triode to ground. This value can be increased to 2 μ f if desired, but introduces an annoying time constant if made much larger.

Because a codan of this type is normally inserted between the detector and the first a.f. stage, plate supply filtering is important, or the codan will also function as a hum injector. The filament must also be balanced to ground, either with a center-tap, or a center-tapped bleeder, as shown in the lower part of Fig. 3. Filament circuits with one side grounded usually introduce hum when used with high-gain a.f. systems. This codan can be disabled by inserting a switch at X (Fig. 3), which disconnects the plate of V1 from the circuit.

Actual operation of this codan is smooth and trouble-free. The only critical adjustment is that of level, made by the grid potentiometer of V1. Sensitivity may be increased somewhat by reducing that tube's plate voltage. This is done by reducing the value of the lower leg of the voltage divider from 10,000 ohms to a lower value such as 5,000 ohms. Operation then occurs with an a.v.c. voltage of slightly less than -2.

An even more smoothly adjustable and very sensitive codan, which does not load the a.v.c. circuit, can be made by taking advantage of the fact that the cutoff voltage of a pentode is a function not only of the grid and plate

voltages, but also of the screen voltage³. As the (positive) screen voltage is reduced, the (negative) cutoff voltage of the pentode is also reduced. Fig. 4 is the circuit of a pentode-triode codan. Here the grid potentiometer has been eliminated, and with it the loading of the a.v.c. circuit by the codan. The level is controlled by adjusting of the screen voltage. With the constants shown, satisfactory operation is possible with any a.v.c. voltage above about -0.5. The triode in this codan can be replaced with a pentode, if desired, but operation will be dependable only if the pentode is of the sharp cutoff type, such as a 6SJ7. A remote cutoff pentode here will defeat the purposes of the receiver a.v.c.

Operation

Operation of a receiver equipped with a vacuum-tube codan is simple, straightforward, and gratifying. The codan level is commonly set slightly above the level of background noise, so that the speaker is silent when no carrier is tuned in. Set it by tuning to a "dead" frequency adjacent to the desired band, and adjusting the codan until noise is heard. The adjustment is backed off slowly until the noise becomes inaudible, and is then left alone. After this adjustment, all signals that rise above the noise level come through, but the pandemonium formerly heard on vacant channels is replaced by silence.

It is also practicable to adjust the codan to pass up all stations whose carriers are below a given preset level. As an example, on the 5-15-mc band, with the codan set just above noise level, in Buffalo, N. Y., in June of 1951, 253 carriers were audible. With the codan set to eliminate all carriers weaker than BBC, only 7 carriers were detected in the 5-15-mc band.

Other applications

Controlling voltage for a codan need not be supplied by the a.v.c. circuit, but can come from another source. A self-adjusting codan, using opposed control voltages from a signal channel and a noise channel¹, has been in use for some years in ship-to-shore telephone service. Although this circuit is too complex and costly for any but large commercial installations, its operation has been very dependable over a period of years.

If and when a truly satisfactory device for discriminating between music and gabble (including singing commercials) is developed, the output of this discriminator can be made to silence the receiver with a codan type circuit.

REFERENCES

- Heising, R. A. Radio Extension Links to the Telephone System, Bell System Tech. Journal, Vol. 19, 1940, 611-646; or Bell Telephone System Monograph B-1255, 1940, 36 pp.
- Terman, F. E. Radio Engineers' Handbook, New York, 1943, p. 653.
- RCA Tube Handbook HB-3, Vol: 3-4, Receiving Tubes, 6SJ7 curve 92CM-6443R1, March 5, 1948.

—end—

TV service technicians, picture-tube sales agencies and manufacturers commonly receive complaints of dark splotches or stains on the screen of a magnetically deflected picture tube. In almost every case, the complainant believes that the stain—really an ion burn—is caused by a defect in the tube itself and that the tube should be replaced under the usual warranty or guarantee.

Many set owners and service-contract agencies have found to their discomfort that few, if any, tube manufacturers replace tubes which have been so damaged. Ion burns are caused by improper adjustment of the ion-trap magnet (beam bender) not by any defect in the tube or component failure. Since ion burns are caused by improper adjustment of the receiver, we can do much to prevent them by becoming familiar with the causes of such burns and methods of preventing them.

Ions are charged minute particles of any element. A few oxide ions are liberated along with the electrons when the oxide-coated cathode in the cathode-ray tube is heated. Additional ions are produced by the impact of the high-velocity electrons on residual molecules of gas or on the metallic components of the tube structure.

These ions have the same charge as electrons but weigh many times more. In electrostatically deflected tubes, ions and electrons are deflected equally over the entire screen so the ions do little noticeable damage to the screen. The screen may darken after the tube has been in operation for a considerable length of time, but the effect is not too objectionable because the effect is gradual and occurs evenly over the face of the tube.

In a magnetic field, the deflective force on a charged particle depends on its weight and momentum. Since the momentum of an oxide ion is about 160 times greater than that of an electron, a magnetic field just strong enough to deflect an electron stream will have little noticeable effect on ions in the stream.

Thus, in a properly adjusted magnetically focused and deflected system, the electron streams will be deflected to all parts of the screen while the ions reach it in a spray-like pattern which is densest at the center. These ions bombard the fluorescent screen material. They do not cause fluorescence but they coat the bombarded area with a layer of inactive or deactivated material, which is not readily penetrated by the electrons when the tube is operated with comparatively low second-anode voltages.

Ion burns are shown in Photos A and B. Photo A shows the circular ion burn which is common on round tubes and which is sometimes seen on rectangular tubes. Photo B illustrates the X-burn common in rectangular tubes. Under normal operation, positive charge on the inner conductive coating of the tube tends to concentrate on the corners. The strong electrostatic charge on these points combines with the varying mag-

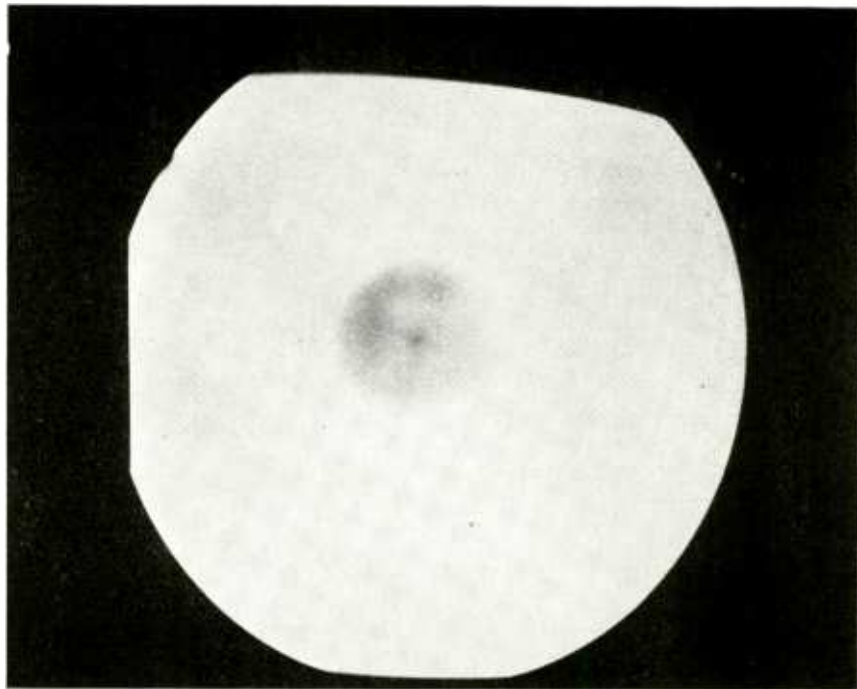

Photos A and B Courtesy General Electric Co.

Photo A—Type of burn common on round electromagnetically deflected tubes.

ION

By ROBERT F. SCOTT

netic fields produced by the deflection coils to produce the burn pattern shown. The X-burn is most common when the tube is operated with comparatively low second-anode voltage. With high voltages, the ions reach such high velocity that they are not so readily deflected by the electrostatic charges in the corners so they produce a circular burn like that on a round tube.

Ion traps

One way of eliminating ion burns is to coat the inner surface of the screen with a material which is readily penetrated by the electron stream but not by the negative ions. This method is based on the fact that an electron will pass through approximately 30,000 times the thickness of material required to stop and absorb an oxide ion of the same energy. The usual ion-proof coating consists of a very thin layer of aluminum which has been evaporated onto the inside surface of the phosphor. Another coating material which has been used with some success is potassium silicate. The aluminum backing is preferable because its reflective surface improves contrast and picture brightness. The electron stream is slowed somewhat by its passage through the metallic backing, but, with normal second-anode voltages, the loss of energy is adequately compensated for by the improved contrast and apparent increase in brightness produced by the

reflective surface immediately behind the fluorescent screen.

Most modern picture tubes have ion traps built into the gun structure. In one type of ion trap, the forward end of the first anode and the rear end of the second anode are cut so the gap between them makes an angle of approximately 75 degrees with the longitudinal axis of the tube as shown in Fig. 1. A strong electrostatic field is produced by the difference in potentials on the first and second anodes. The first anode operates with voltages between 300 and 410 and the second anode has voltages ranging from approximately 8,000 to about 19,000. This electrostatic field is at right angles to the gap. Since the electrons and ions have the same charge, the field will affect both so as to deflect them upward so they cross the gap at right angles. The angle through which the ions and electrons are deflected is great enough to cause them to strike the inner surface of the second anode where they are collected.

But, we have trapped the electrons as well as the unwanted ions. Since the electrons must strike the screen to produce the fluorescence required for the picture, a means must be provided to prevent them from being trapped along with the ions.

Remembering that electrons are easily deflected by magnetic fields while ions are not, we use a strong magnet—called an ion-trap magnet or beam

bender—to deflect the electron stream so it does not strike the wall of the second anode along with the ions. Double-field beam benders are usually used with the slashed-gun ion trap shown in Fig. 1. A strong magnet is placed so its field traverses the neck of the tube immediately behind the gap and a weaker magnet immediately in front of the gap. The purpose of these magnets is to counteract the effect of the electrostatic field on the electrons so that they continue on a straight path through the second anode structure into the fields of the focusing and deflecting coils. The solid line on Fig. 1 shows the path of ions and electrons when a beam-bender is not used and the dashed line shows the effect of the magnetic fields on the electron path when the beam-bender is correctly adjusted. The electron stream is deflected downward by the rear magnet, straightened out parallel to the axis of the tube by the electrostatic field, and deflected slightly upward by the smaller magnet so it passes cleanly on its way through the front (limiting) aperture of the second anode.

A slightly different type of ion-trap

ion burns. According to the diagrams in Figs. 1 and 2, the ions are trapped by the second anode regardless to whether or not a beam-bender is used.

Figs. 1 and 2 show the electron beam passing cleanly through the limiting aperture. This condition exists only when the beam bender is properly positioned. If the magnet is too far forward, the electron stream passes through the aperture at an angle. Some of the high-velocity electrons pass cleanly through the hole while others strike its edge. The electrons strike the metal with such speed that the heat produced by the collision vaporizes the area being bombarded. Note the ragged edge of the aperture of the top anode disc shown at the left in Photo C. Compare this with a normal anode disc shown at the right. The damage to the left-hand disc was produced by operating the tube for about 15 seconds with the brightness control turned up and the ion-trap magnet improperly placed. The metal which was vaporized was hurled onto the center of the screen and produced an ion burn. The damaged

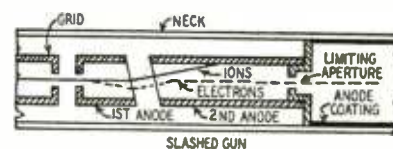

Fig. 1—Slashed-gun type of ion trap.

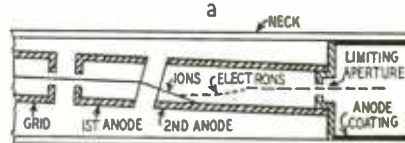
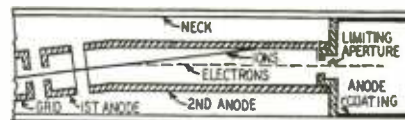

Fig. 2—Two kinds of bent-gun traps.

distorts the electron beam and makes it impossible to obtain sharp focus.

It is vitally important that the ion trap magnet be correctly adjusted immediately after the set is turned on when installed. Therefore, the beam-bender should be approximately positioned before the set is turned on.

Double-field beam-benders must always be properly polarized on the neck of the tube. We do this by placing the larger magnet or the larger pair of pole pieces toward the base of the tube. This applies to all types of double-field beam benders. The poles of the stronger magnet should be adjacent to the flags as shown in Fig. 3-a. Polarity should be as shown in Fig. 3-b. Since some of the double-magnet types come apart easily and may have been incorrectly reassembled, it is advisable to check the polarity and correct it if necessary. You can do this with a small, inexpensive pocket compass. The north pole of

BURNS

structure is used in some picture tubes. This type, shown in Fig. 2-a, is called the bent-gun assembly. The cathode, first anode, and the rearmost portion of the second anode are set at an angle to the longitudinal axis of the tube. Electrons enter the rear of the second anode at an angle which directs them toward a point on the inside surface of the element. In this type of ion trap, a single-field magnet of proper strength and polarity is used to deflect the electron stream so it passes cleanly through the limiting aperture in the second anode.

The tilted or inclined-gun ion trap shown in Fig. 2-b operates like the bent-gun ion trap shown in Fig. 2-a. This is a slashed-gun trap set at an angle to the longitudinal axis of the tube. The off-set gun assembly and the electrostatic field between first and second anodes deflect the ions and electrons so that they are directed toward a point on the inner surface of the second anode. A single-field beam bender of the correct strength is all that is necessary to realign the electron beam so it coincides with the axis of the tube and passes cleanly through the aperture.

Another source of ions

We have seen how the oxide ions released from the cathode are trapped on the second anode so they cannot reach the screen. This being the case, you probably wonder how incorrect adjustment of the beam-bender can cause

disc was taken from a tube which was operated with second-anode voltages near the design center. If the tube is operated with lower second-anode voltage, the disc may still be damaged but since the electron velocity is not so

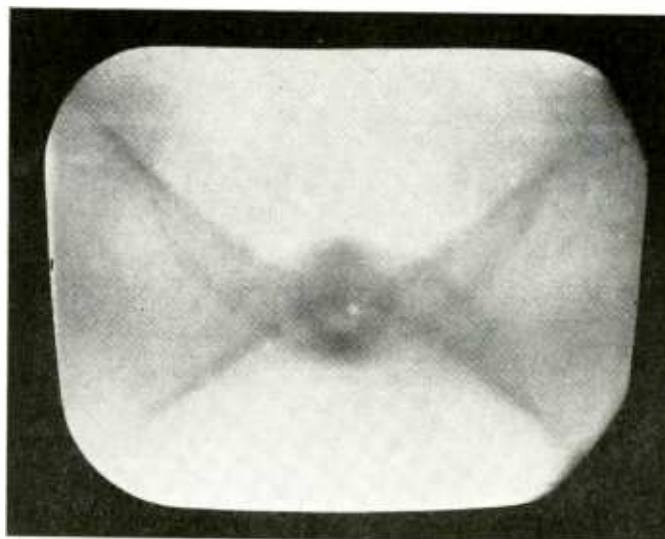

Photo B—A rectangular-tube ion burn.

great, the vaporized metal may be deposited on other parts of the tube before reaching the screen. Thus, ion burns may not be produced, although the increase in the size of the aperture

the ion-trap magnet will attract the end of the compass needle which normally points south. It is particularly important that you check the polarity of electromagnetic ion-trap magnets

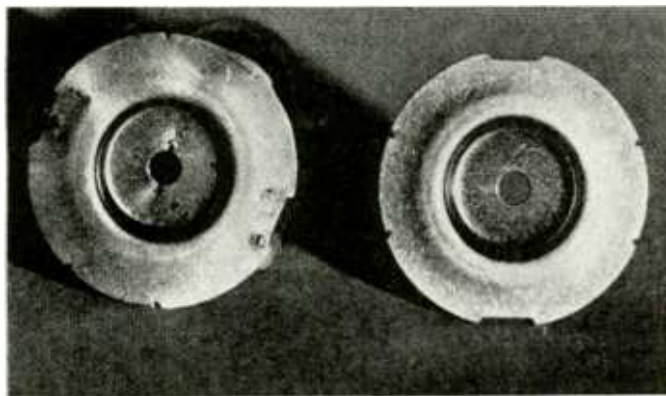

Photo C—Damage to anode's limiting aperture caused by improper alignment of the beam.

Courtesy Allan B. DuMont Labs

such as the RCA 203D1 if the set has been serviced or converted. It is usually more convenient to install this type so the magnets swing down under the neck of the tube. If polarity is incorrect with the magnet assembly in this position, reverse the connections between the coil leads and the power supply, or rotate the assembly so the magnets are on top of the neck.

One popular type of beam-bender has a strong bar magnet and a weaker ring magnet. It should be mounted so the bar magnet is on the side opposite the high-voltage connector. A unit of different construction uses two bar magnets in an assembly which holds them parallel to the neck of the tube, one on each side. This type should be mounted with the open ends of the magnets over the flags with the arrow pointing toward the high-voltage connector.

A rather unusual type of double-field beam bender has a *single* magnet which is mounted parallel to the length of the tube. The fields of different strengths and opposite polarities are produced by magnetizing the magnet crosswise instead of lengthwise and by fashioning the pole pieces so those diagonally opposite each other have the same polarity. Mount this type so the larger poles are adjacent to the flags and the magnet is on the side of the tube opposite the high-voltage connector.

A single-field beam-bender may be placed over the neck of the tube with either end on first. Slide it forward so the front edge of the pole piece is even with the rear end of the second anode as shown in Fig. 4. The *south* pole of the magnet should point toward the right side of the neck when viewed from the base end of the tube.

Adjusting the beam-bender

When adjusting a double-field beam-

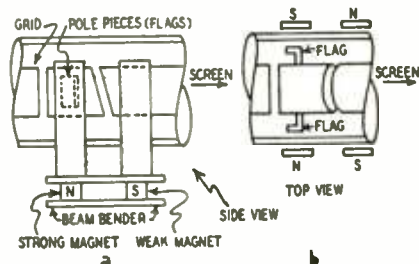

Fig. 3—Positioning of beam benders.

bender, allow the set to warm up with the brightness control in the minimum-brightness position. Slowly advance the control until a raster is just visible. Move the magnet assembly forward and backward while rotating it slightly around the neck of the tube. Slide and twist the beam-bender in the direction which brightens the raster. Turn down the brightness control as the raster grows brighter. Continue adjusting the beam-bender until the brightest possible raster is obtained. Turn off the set and note carefully the position of the stronger magnet with respect to the flags. The magnet is too weak and should be replaced if the brightest raster is obtained with the beam-bender more than $\frac{1}{4}$ inch ahead of the flags or up against the focus coil.

As a final check on the position of the beam-bender, turn up the brightness to slightly above normal and vary the focus control or setting of the focalizer for clean line structure. Adjust the focusing yoke to eliminate neck shadows if they appear. With clean, well-defined line structure and a shadow-free raster, touch up the setting of the ion trap magnet for brightest raster.

Single-field beam-benders require special care because it is possible to obtain maximum brightness with the magnet in *two* positions. The one nearer the base of the tube is correct. Turn up the brightness control about halfway or until a dim raster is obtained. Rotate the magnet assembly slightly from side to side and slide it back and forth along the neck of the tube, stopping at the point of maximum brightness. Reduce the brightness and again touch up the setting of the magnet for maximum brightness. Then, turn up the brightness control until the raster starts to expand (bloom). Again adjust the magnet for maximum brightness.

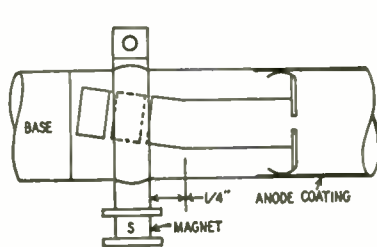

Fig. 4—Single-magnet type of bender.

If the raster does not appear with all conditions normal (with the set operating properly) turn down the brightness control, rotate the beam-bender so the magnet is on the opposite side of the neck. Repeat the adjustment procedure. Try a new magnet if the raster does not appear after rotating the assembly.

The field strength required in an ion-trap magnet varies directly as the square root of the second-anode voltage. Thus, a magnet which is satisfactory with voltages of 8 to 10 kv will not be suitable for use on the same tube with anode voltages of 14,000 or more.

Some of the new Du Mont picture tubes have a redesigned gun structure which requires a beam-bender of considerably less strength than that used on earlier tubes of the same type. Thus, if a tube has been replaced with a newer one, of the same type, you may find that the brightest raster is obtained with the beam-bender close to or directly on the base of the tube. In such cases, either replace the beam-bender with a weaker one or reduce the strength of the original unit by placing a paper clip or similar piece of metal across its poles.

Procedure will be the same for the newer electrostatic focusing tubes, since the ions are trapped and the electron beam straightened out before it reaches the focusing elements (in either magnetic or electrostatic focused tubes).

Precautions

1. Do not operate the tube before adjusting the beam-bender.
2. Do not operate the set longer than necessary while making the preliminary adjustments on the ion-trap magnet.
3. Always keep the brightness turned down as the raster brightens while the beam-bender is being adjusted. Always make the final check of the beam-bender setting with the brightness set slightly higher than normal. This insures that the limiting aperture will not be burned because of improper beam alignment.
4. Neck shadows are often encountered when adjusting the ion trap. DO NOT READJUST THE ION TRAP TO ELIMINATE THESE SHADOWS IF THEY ARE PRESENT WHEN THE ION-TRAP MAGNET IS ADJUSTED FOR MAXIMUM BRIGHTNESS. Eliminate neck shadows by adjusting the position of the focus coil or focalizer and by forcing the yoke firmly against the flare of the tube.
5. Be careful about handling and storing ion-trap assemblies. Do not store them in direct contact with each other or with metal shelves or in metal drawers. Do not drop or otherwise subject them to mechanical shock, which may weaken the magnets.
6. Always check the setting of the beam-bender immediately after readjusting the position of the focus coil or focalizer or the deflection yoke.
7. Check the position of the ion-trap magnet whenever the set has been moved from one place to another.

—end—

With the author's notes on experiences with indoor antennas for picking up hard-to-get-well stations in supposedly good signal areas. How the antenna locations are surveyed and the antennas installed, switched and matched to the receiver.

By H. E. WARRINER

THE Horse Show on channel 11 started it all. We had shopped for a television set sensitive enough to work on an indoor antenna. The idea was to control reception entirely from the living room and free ourselves from trips to the roof of the apartment house for a "better spot." (Even on our roof directional antennas and rotary equipment are not always ghost-free.) Living in a primary broadcast zone with better than 5,000 microvolts signal strength, the biggest problem was a sensitive front end—we thought! When the salesman brought a manufacturer's sales engineer to the set and the engineer said "Good down to 30 microvolts," we bought.

Upon delivery with a V-ball indoor antenna the set demonstrated its power with excellent picture contrast and sound on all seven New York City channels. But here our ghost story began. Critical adjustment was necessary to cancel out a strong multipath signal from a nearby tall building. Our first interest was the Horse Show over channel 11. Multipath effect was so strong that a horse and rider was not just a double feature but a cavalry regiment! Critical adjustment of the V arms of the V-ball in various places in the room helped, but still channel 11 would not give with a clear picture. Inquiries around the house showed that others had given up the channel (except for one neighbor whose roof antenna had been bent into pretzel shape by a hurricane. While other set owners were rebuilding their dipoles, this man would not touch his pretzel because: "Now I get channel 11 perfectly!").

The V-ball antenna showed up certain "hot spots" in the room for various channels. The best place for 4 is on the radio-phonograph; 2, 5, 9, and 13 come in best with the V-ball positioned on top of the TV set; 7 can be found on the piano keyboard; and 11 is strong on top

FEBRUARY, 1952

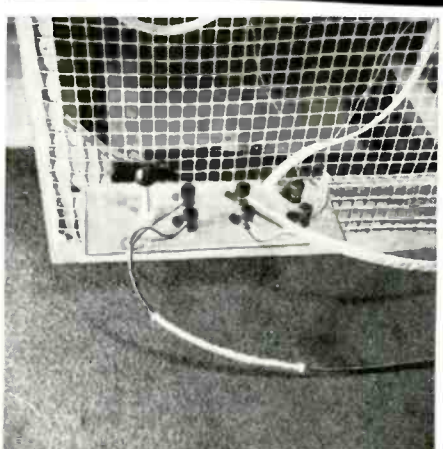

Fig. 1—Antenna switch at rear of set.

of the piano as well as in certain spots on the floor. A search of the whole apartment for the hottest spots naturally followed.

The search for signals

Two facts stand out as result of experiments with a variety of indoor antennas. Very-high-frequency wave theories to the contrary, we discovered, first, there are areas of good signal strength inside the house—you have to hunt them with the proper equipment, but they are there; second, once found, the only problem is to tap these areas and lead the signal back to the TV set without great loss or ghosts from line pickup.

The first step was to make an antenna connection panel for the back of the set, as shown in Fig. 1. (The wire screen is pet-proof.) It was constructed on a 3 x 9-inch bakelite strip with a 3-position rotary ceramic switch, wired to three sets of double binding posts for 300-ohm lead. The panel was mounted on angle brackets with the switch handle near the side of the set. The V-ball antenna, the built-in antenna of the set,

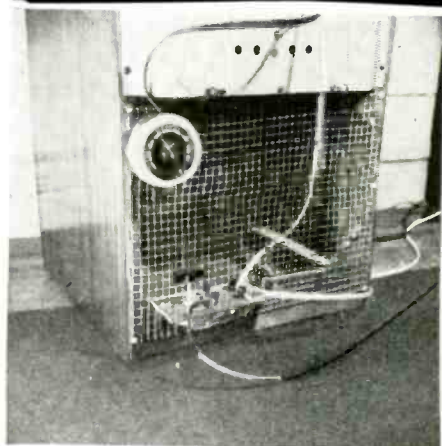

Fig. 2—Tuned antenna matching unit.

and a loose 300-ohm line were hooked into the panel binding posts. The built-in antenna is satisfactory for some channels, particularly 2 and 9. But, although signal strength is good on other channels, the position of the set causes ghost problems.

As a measure against mismatch on all lines the set was equipped with a variable matching pad box (Fig. 2).

stub rigid. A small nut was soldered on to the trimmer shaft for handling. Once the shorting bar is properly adjusted the trimmer helps with fine adjustment. This device clips firmly to the V-ball and has scared away many a ghost.

Such success with the V-ball in the living room naturally led to sounding out the rest of the apartment for ghost-free hot signal areas. The TV set rolls easily on casters, so it went along to monitor the search. A number of good spots were found, but it was awkward to leave the V-ball balanced on top of doors, on dressers, or hanging from mouldings. We decided to find the hot spots and install and orient fixed antennas there.

One such item was a butterfly window antenna which had failed to work satisfactorily in any window because of ghosts. So the butterfly was mounted on the end of a mop handle to get elevation and avoid body capacitance. It was connected to the set by a generous length of 300-ohm line and was used as a probe. Just inside the bedroom door at the ceiling moulding an excellent spot that gave strong and clear pictures on channels 2, 4, 7, 9, and 13 was discovered. A variation of 4 inches away from this spot cancelled out acceptable reception. The antenna also had to be angled away from the wall for best reception. The butterfly was extended from the top of the door in this exact location (Fig. 5) and adjusted for good reception by watching the TV screen. It was not possible to locate a clear area in the bedroom for channel 11. However, the butterfly works best for channels 2, 7, and 9 and earns its keep in those jobs.

The directional rhombic

Another device giving excellent ghost-free service is a rhombic antenna, strung from the top of the bedroom

locate signal somewhere in the house. tune the antenna to maximum gain, and

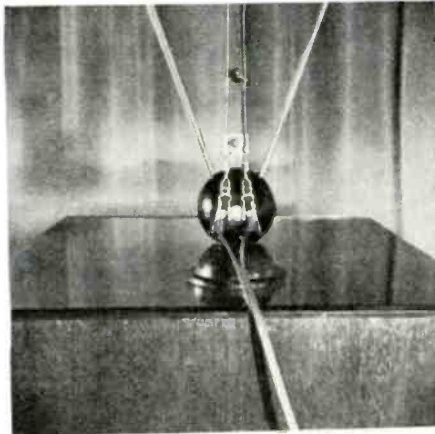

Fig. 4—Tuning stub mounting details.

then deliver it to the set without loss or mismatch.

The V-ball matching stub can be made of galvanized wire—for rigidity—or heavy copper bus bar. I used galvanized wire simply because it was at hand and would hold the shape required. Starting with 32 inches of wire a U was shaped with $\frac{3}{8}$ -inch separation between the bars of the U. At the ends of the U alligator clips were attached to bite onto the V-ball connections and hold the stub vertically in the center of the V (Fig. 4). The stub is tuned by a sliding shorting bar across the two bars of the U. The shorting bar was also made of galvanized wire. A binding post was used for a nonconductive handle. The wire was wrapped once around the post, and the ends were wrapped around the bars of the U, free enough to slide up and down but snugly enough to make a good connection.

As further modification a 36- μ mf ceramic trimmer capacitor was soldered between the alligator clips. A small square bakelite washer was tightened down on the bars of the U to make the

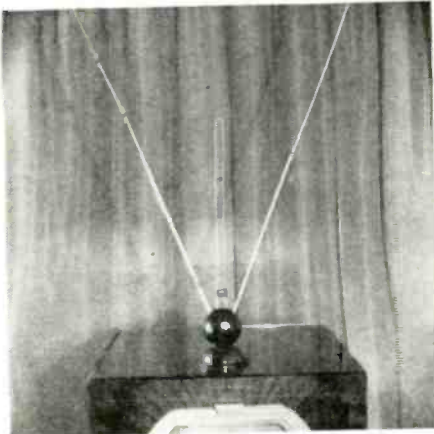

Fig. 3—Shorting stub for the antenna.

greatest on high-band channels, where position is critical.

A modified V-ball

Taking the matter of tuning still another step, an additional gain booster was devised for the V-ball itself. This is a tunable stub right at the apex of the V, attached to the line connections

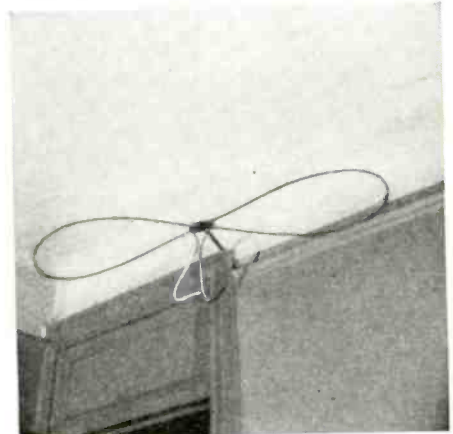

Fig. 5—Butterfly works on 2, 7 and 9.

door across the ceiling to the opposite wall moulding. This was easily constructed of bell wire, which can be purchased in many colors to harmonize with any ceiling. The rhombic antenna is a diamond-shaped rig of wire, the widest separation in the middle being one-half the length of the span. If the room is 15 feet long, the diamond should

the tubes from tuner to picture tube. After that, the items listed above should be checked before trying a new picture tube.

Afterglow

In some receivers I have noticed a bright spot in the center of the picture tube after the receiver is shut off. In one of the receivers this has left a burned spot on the face of the tube. How can this condition be corrected?—G. A., Haddon Heights, N. J.

The afterglow which you have noticed upon shutting off the receiver is common with many sets having the permanent-magnet type of ion trap. In the coil type ion traps the magnetic field collapses when the set is shut off, hence the beam does not reach the screen and leave the afterglow caused by the charged capacitors and the heated filament of the picture tube. Adjusting the brilliancy control immediately after shutting off the receiver minimizes this condition. Little can be done when the permanent-magnet type of ion trap is used because it keeps the beam traveling toward the tube screen. If the trap is properly adjusted for maximum picture brilliancy, the danger of a brown spot is minimized.

Brilliance decreases

In a Motorola 14T1 receiver the picture darkens as the brilliancy control is advanced fully. The contrast control still works though there is loss of vertical synchronization as the contrast is decreased too much. What is the cause of this condition?—J. U., Neptune, N. J.

This indicates insufficient high voltage. Advancing the brilliancy control increases beam current but with poor regulation there is a decrease in high voltage, and the beam has not sufficient velocity to overcome the space charge set up by the impact of the electron beam on the phosphor coating.

Check the high-voltage system and replace the high-voltage rectifier if it has developed low emission. The horizontal output tube should also be checked for a decrease in efficiency. Make sure the ion trap is properly placed on the neck of the picture tube.

When the contrast control is turned down it will decrease sync amplitude and may cause sync instability. Correction of the high voltage will, however, affect the operation of the contrast control because it will aid in establishing the proper relationship between contrast and brilliance.

Horizontal foldover

I have converted a Philco model 1000 from a small to a large size picture tube. I have replaced the 6AS7 with a 6W4. The set works all right but a white smear pulls in from the left side of the picture. The brightness control also seems to cause picture blooming when it is advanced. What could cause these troubles?—E. A., Woodhaven, N. Y.

The white smear on the left side in your converted Philco is referred to as "foldover" and is caused by defects in the damping circuit. Try adjusting linearity and if this does not help, try another 6W4 damper. Replacement of the 6AS7 with a 6W4 upsets circuit linearity sufficiently to cause this trouble. Try replacing the voltage-boost capacitors with others of different value.

Horizontal foldover can also be caused by defects in the horizontal oscillator section. You might try tube replacements there as well as checking the parts.

If the brightness control tends to cause picture blooming when it is advanced, you should check the position of the ion trap and increase the high voltage if possible. Insufficient high voltage will cause picture expansion as the brilliancy control is advanced.

Tunable bars

In a Westinghouse receiver there is an overly dark picture background with white bars (horizontal) when a station is tuned in. The bars do not appear in the raster when a station is not being received.—E. B., Cincinnati, Ohio

Bar interference which appears only when a station is tuned in is usually caused by a cathode-filament short in the local oscillator. The cathode-filament short will introduce hum in the i.f. stages only during the mixing process when a station is being received.

At other times the hum in the oscillator tube does not enter the i.f. stages because the oscillator frequency is much higher than the i.f. frequency. A new local oscillator tube should correct this trouble. Otherwise check lead dress in the oscillator circuit as well as for defective components.

Local oscillator drift

In a Farnsworth 260 receiver there is severe oscillator drift which cannot be corrected by the fine-tuning control. Would it be advisable to add automatic-frequency control to this receiver to stabilize the oscillator?—M. B., Philadelphia, Pa.

Pronounced oscillator drift indicates a defective oscillator tube or other part in that circuit. It would be advisable for you to find the defect rather than try adding an a.f.c. to correct this condition. When replacing components in the local oscillator make sure you get exact replacements because some oscillator parts are of the negative temperature-coefficient type and if the proper one is not installed, oscillator drift will be troublesome.

An a.f.c. circuit would not help much here. TV oscillator a.f.c. has also caused considerable trouble at times and manufacturers have discontinued its use in receivers.

Conversion troubles

I have converted a Stromberg-Carlson model TV12 to 20 inches. I have replaced the high-voltage transformer

and deflection yoke but do not get full beam focus. What adjustments are necessary?—J. M., N. Y., N. Y.

The focus coil used for 10- or 12-inch picture tubes is almost always inadequate in focusing the beam in large picture tubes when the second-anode voltage has been much raised. A larger focus coil developing greater magnetic field strength should be tried (with due consideration for the higher voltage drop across the new coil and the effect upon the receiver low voltages). Higher strength PM types are commercially available, and RCA uses a special high-strength type in some of their models.

If best focus is at the center of the picture reduce focus coil current by reducing resistance of the shunting network across it. Good focus for most of the screen can be achieved by proper placement of focus coil along the neck of the tube. The yoke must also be placed snugly against the flare of the tube. The ion trap should be properly positioned. Proper adjustment of the brilliancy and contrast controls helps. Full beam focus to the edges of the mask is rarely achieved except when special yokes are used.

Uncontrolled brilliancy

In a Transvision receiver the picture is excessively bright with retrace lines showing on the screen. The brilliancy control is ineffective and I've replaced the low voltage rectifier 5Y4 tube several times because of burnout.—A.K., Roosevelt, L. I.

Excessive brightness would indicate a defect in the brightness-control circuit or an abnormal increase in the high voltage. This would cause retrace lines to appear because the low bias would not allow the tube to cut off during blanking pulse periods. If the high voltage is excessive it may be caused by a slightly gassy high-voltage rectifier or horizontal output tube. This would also cause some picture shrinkage.

Check the brilliancy control and measure the voltage between the cathode and grid of the picture tube. See if the brilliancy control gives a substantial variation, and whether the voltage is negative with respect to the cathode through a range up to approximately 60 volts. Check all capacitors associated with both the cathode and grid of the picture tube, for a leaky one will allow B-plus to get to these tube elements and upset the bias level. This, as well as other circuits which draw excess current, can cause abnormal drain from the power supply and necessitate the low-voltage rectifier replacement that you mentioned.

After correcting the excess brilliancy condition the current drawn from the power supply should be more nearly normal. If not, take a resistance reading to localize the partial short which is causing the additional current drain. Make sure your filter capacitors are not contributing to this condition by having too low a leakage resistance.

—end—

Constant Voltage Lines

By N. H. CROWHURST

FEEDING a number of speakers from a single amplifier has caused the PA man many a headache. It's not always easy even when all the units have the same impedance and require equal proportions of the total power, though the problem is then theoretically simple. But when the problem includes units of different impedances requiring different proportions of the power it can become a real headache.

The *constant-voltage* system of distribution eases the headache considerably, and generally does a much better job than the older methods. Such systems have become very common in Europe and are fast gaining ground in America. They are usually designated by the nominal voltage used. The American standard is a *70-volt line*; the European, a *100-volt line*.

The constant-voltage system has one apparent disadvantage—a separate output transformer is required for each speaker. But this disadvantage is more apparent than real. True, when an amplifier is working only one speaker, located close to it, there is no point in using more than one transformer for matching the output to the speaker. Doing the matching in two steps adds to cost by one transformer, and also adds slightly to the audio losses. But when the amplifier is feeding a number of

speakers, matching problems may well make separate transformers worth while.

Voice-coil impedances range from 2 to about 16 ohms. (Sometimes values outside this range are met, but they are not common). Let us take 12 ohms for some examples because it makes calculating easier. Suppose eight such speakers are connected, all to receive the same power. The arrangements shown in Fig. 1 give over-all impedances of 1.5, 6, 24, and 96 ohms. It is probable that even a multi-ratio output transformer will not provide most of these matchings, so some other arrangement must be figured out, including one or more resistors as "dummies" to pad out the values. And the number of speakers in an actual installation may not be so convenient for series-parallel connection as our example of eight.

Suppose next that all speakers still have the same coil impedance, but it is desired to feed them at different levels. Fig. 2 shows two arrangements. Both give LS1 four times the power received by LS2 or LS3. These arrangements are fairly simple, but the evolution of a suitable circuit for larger numbers becomes difficult.

The constant-voltage line simplifies all these problems, makes a far more versatile system, and is well worth the extra cost of a transformer for each speaker. There is another advantage: It is always best to operate dynamic type speakers in parallel, otherwise electrical damping is lost, and peculiar effects due to interaction between LS impedances are noticed. In constant-voltage operation, all units are always parallel-connected, even when the power delivered to different units is varied. If numbers of speakers are operated in parallel by direct connection, the resulting impedance is so low that much of the output power is lost in connecting lines unless very large cable is used. In the constant-voltage system, impedances can be kept up to a reasonable figure.

A nominal line voltage is chosen, usually 70 or 100 volts. This forms the basis of all the calculations. This does not mean that there is *always* a signal of 70 or 100 volts, because it naturally fluctuates, as audio signal always does. The stated voltage represents a nomi-

nal *maximum output level*. Perhaps the easiest way to get the idea is to think in terms of a sine-wave signal, fully loading the amplifier. The amplifier then can be regarded as providing a constant voltage for all the speakers connected to the line, just as an electric line does for all the appliances connected to it. The generator at the power station has a certain maximum load capacity, and consumers' loads may be connected until that capacity is reached, the power taken by each depending on its load impedance and the line voltage. We are quite used to referring to electric lamps and other appliances as, "110-volt, 40-watt," but the same method of rating speakers may seem strange at first.

Each speaker is fitted with a transformer to match its voice-coil impedance up to an impedance which accepts the desired wattage when the nominal voltage is applied. Some speakers may be fitted with multi-ratio transformers so their power rating can be adjusted. This makes an installation very versatile, and avoids the loss of power caused when an individual volume control is used on each speaker. You simply vary the number of watts accepted by the speaker. Different voice-coil impedances are also taken care of by the speaker-matching transformer.

Fig. 3 illustrates an ideal calculation. LS1 and LS2 each have an impedance of 5,000 ohms, so they will accept 2 watts each at 100 volts. (Use Ohm's law, or the chart of Fig. 4.) LS3 has a voice-coil impedance of 2 ohms, and uses a transformer of ratio 70 to 1. From the chart of Fig. 5 this gives an impedance of almost 10,000 ohms, which from the other chart rates at 1 watt for 100 volts. The total wattage load is $2 + 2 + 1 = 5$. Using the chart again, this corresponds to an impedance of 2,000 ohms (still for 100 volts). So an amplifier to supply just this load would need to supply 5 watts matched into 2,000 ohms.

A large amplifier may be used to supply a load smaller than its own output. For example, suppose a 60-watt amplifier is used to feed the foregoing case requiring only 5 watts. The nominal voltage is used to calculate both LS and amplifier output impedances.

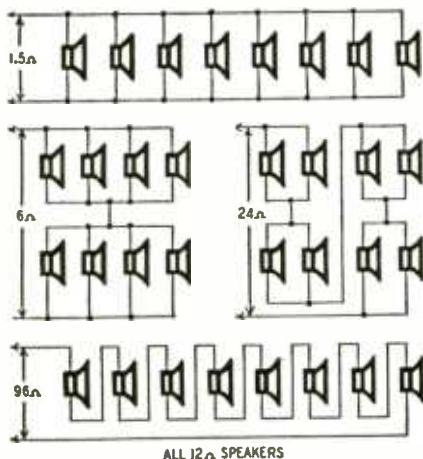

Fig. 1—Four ways of connecting eight 12-ohm speakers to receive equal power.

A 60-watt output for 100-volt operation should be matched into 170 ohms. The load actually connected is 2,000 ohms. Some amplifiers working into a light load like this will be unstable. To prevent this, a resistance load may be added to absorb the surplus power. In the example suggested, a resistance load to absorb 50 watts would be adequate, and from the chart the value required is 200 ohms. If the amplifier were to be operated continuously at maximum output, this resistor should have a dissipation rating of 50 watts,

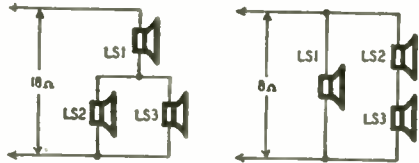

Fig. 2—These hookups give four times as much power to LS1 as LS2 or LS3.

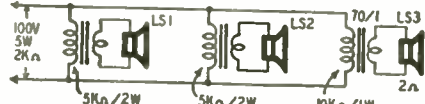

Fig. 3—A constant-voltage line, with the speakers receiving unequal power.

but in practice a much smaller (10- or 20-watt) resistor could be used.

Sometimes the reverse of the previous problem arises. The nominal load connected *exceeds* the power output of the amplifier. Here matters are adjusted by a different method. Suppose the load is made up of a number of speakers rated at 2 and 5 watts for 100-volt line, adding up to a total load of 80 watts. The load impedance of 80 watts worth of speakers will be 125 ohms. The load for a 20-watt amplifier, 100-volt working, would be 500 ohms. Applying a 125-ohm load to the output of an amplifier designed for 500 ohms would probably cut the output down to about 5 watts, and as well likely cause distortion. So

the output must be matched to the actual speaker load of 125 ohms, which, according to the chart of Fig. 4, will give 20 watts at 50 volts, instead of the original basis of calculation, 100 volts. This means the nominal 2-watt speakers, of 5,000 ohms impedance, will get ½ watt, and the nominal 5-watt speakers, of 2,000 ohms impedance, will get 1¼ watts. Note that this is a reduction of only 6 db, so quite a useful volume will be available, although the amplifier is smaller than one planned for 100 volts. Anyway, if the four-to-one mismatch were used, giving only 5 watts or so, there would be loss of another 6 db, and probably considerable distortion.

Use of the constant-voltage system does not necessarily mean special speaker transformers must be used, so a word about picking suitable transformers from stock lines is needed. Makers of speaker transformers mark them variously in turns ratio or impedance ratio. In the former case the chart of Fig. 5 enables the correct *turns ratio* to be found, but the *actual turns* on each winding must suit the job too. A mike-to-line transformer for a ribbon microphone may have the same ratio of turns as a speaker transformer, but this does not mean that either would do the other's job successfully. A good rule for checking the suitability of speaker transformers with an ordinary ohmmeter is that the winding resistance should be between 2% and 20%, of the impedance for which it is to be used. Less than 2% means its inductance will most likely be inadequate, and 20% or more means the windings will absorb an appreciable portion of the available audio power. If the resistance of the voice-coil winding is too low to register on the ohmmeter scale, the resistance of the high side should be compared with its working impedance. Thus, for example, a winding intended to work at 5,000 ohms should have a resistance that lies

somewhere between 100 and 1,000 ohms

Where transformers are specified by impedance ratio—for example, 7,000 ohms to 3.5 ohms—the maker has stated the *best* impedance at which to work the transformer. Using these impedances, it may be expected to be well over 80% efficient (probably over 90%), and have a good response at low frequencies. But these are not the only impedances at which the transformer can work. The important thing, of course, is that the *ratio* of impedances hold true, so the same transformer could be used for 4,000 to 2, 10,000 to 5 ohms, etc. As stated in the previous paragraph, the losses and response must be kept within bounds. If impedances more than two or three times the rated values are used, the transformer's inductance may prove inadequate. If it is used with impedances less than one-third to one-half the rated values it will become quite inefficient.

A few years ago the author built an amplifier with 50 watts output, using a special multi-ratio output transformer of his own design, provided with matching for load impedances of 8, 12.5, 20, 32, 50, 80, 125, and 200 ohms. It can feed a few high-power units direct, using appropriate matching, but more often it is used for 100-volt line distribution, feeding various numbers of speakers. Up to 50 watts nominal loading, the 200-ohm matching is used. If a greater load has to be fed, a lower impedance matching is selected. The outfit is extremely compact, and on various big PA jobs where the author has used it, many other engineers have been amazed that so small an amplifier, with only 50 watts output, can provide such large coverage. The secret lies in making the best use of the watts available. This is just what correct use of the constant-voltage technique enables the PA man to do.

—end—

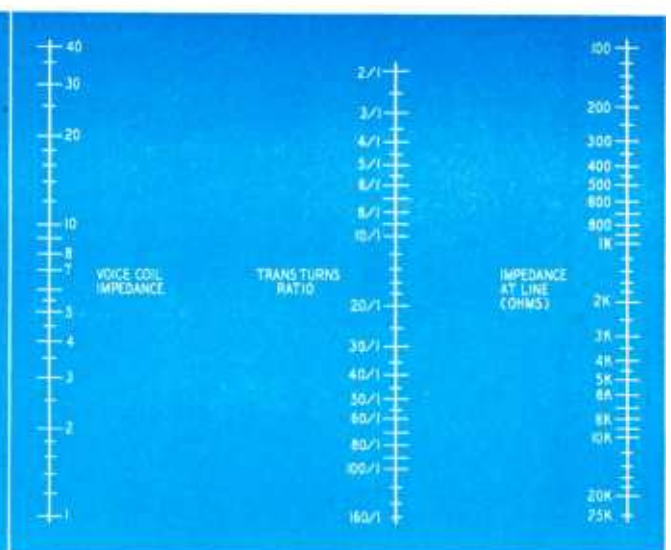
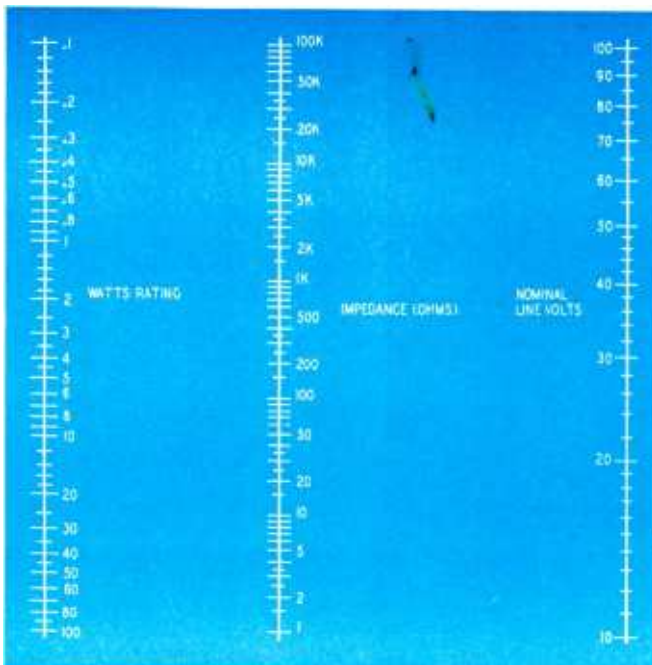

Fig. 4, Left—Constant-voltage chart, showing impedance vs. wattage.

Fig. 5, Right—A chart for obtaining line impedance from turns ratio.

AUDIO WAVEFORM ANALYSIS

By JOHN D. LEDBETTER

THE present demand for high-fidelity audio amplifiers and for better frequency response in the older units has placed the service technician in the role of "service engineer" rather than repairman. Not only is he required to service high-quality audio and sound systems, but he is often requested to improve and modify amplifiers with a poor frequency range. The frequency response of most amplifiers, provided their basic design is good, can often be considerably improved.

Modern test equipment necessarily plays an important part in this new "engineering" role.

Sine wave testing

Distortion, frequency response, overloading, etc., in the audio system can be checked with the following aids: (1) sine waves, (2) square waves, and (3) sweep-frequency records. The first method (illustrated in the setup in Fig.

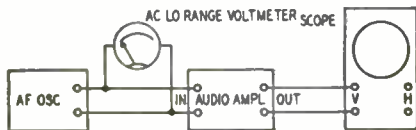

Fig. 1—Checking sine waves with scope.

1) consists simply of a variable audio oscillator and a scope. The oscillator feeds a signal into the amplifier, and the scope (across the amplifier output) indicates what has happened to the audio sine wave as it passed through the amplifier. The low-range a.c. or output meter connected across the audio oscillator output should read the same value of signal input for all applied frequencies.

Let us examine some of the waveforms which can be obtained with sine wave testing. We are familiar, it is assumed, with the sine waveforms shown in Figs. 2-a and 2-b. Suppose that a sine wave similar to that in Fig. 3-a is present at the output, *even though no signal is being fed into the amplifier input*. A logical assumption is that a.c. hum is being picked up at some point in the amplifier. Determine the frequency of the waveform by adjusting the scope frequency control until a single stationary cycle as in Fig. 2-a is obtained; then read the frequency

setting on the scope sweep control. If the frequency is 60 cycles, look for cathode-to-heater leakage in one of the tubes, or stray pickup from the filament leads, power transformer, or some external source. If the hum frequency is 120 cycles, an open or low-valued filter capacitor is indicated.

Sometimes a wide, blurred waveform may appear at the output instead of the usual thin, well-defined line. Such indication is caused by oscillation within the amplifier. *Low-frequency* feedback resulting in oscillation may be due to open plate or screen-grid bypass capacitors or to inadequate decoupling between stages. *High-frequency* oscillation may be the result of defective plate or cathode bypass capacitors, or to regeneration in one or more stages. An open plate bypass capacitor in the output stage, and output leads which are too close to the amplifier input circuit can be notorious offenders in this respect. This condition is often caused by improperly shielded grid circuits in high-gain amplifiers, or by plate and grid leads placed too close to each other. Shielding all grid and low-level leads, and properly dressing grid and plate leads almost invariably corrects this latter condition.

The waveform in Fig. 3-b is the result of modulating a 60-cycle sine wave with 400 cycles. Typical distorted waveforms are shown in, Figs. 4 and 5. Note that the relatively small amount of distortion in Fig. 4-a results in clipping of the positive peaks only, while the high distortion shown in Fig. 4-b has flattened both positive and negative peaks. Positive peak flattening is usually due to overloading or insufficient bias. Negative peak flattening can be caused by a shorted cathode bypass capacitor. The waveform in Fig. 5-a (note the distorted negative peaks) is a typical example of distortion caused by overloading. Fig. 5-b indicates presence of regeneration *and* overload. The terms positive and negative peaks are applicable literally only when checking the waveform at the plate of a particular stage. The usual stage-by-stage checks should be employed to determine the source of distortion. First, be sure that the distortion is due to a defect within the amplifier and *not* from excessive input from the signal generator. Connect the scope's vertical leads *suc-*

cessively across the plate and grid circuits of each stage, beginning with the output stage and working back toward the input until the distorting stage is located. If distortion as indicated by these scope checks suddenly disappears you can be certain that its source has just been passed. Don't forget to check the compressor, expander, and phase inverter circuits. In most cases you will find that the distortion is caused by defective tubes, leaky, open or shorted capacitors, improper grid bias, incorrect plate voltage, resistors that have changed in value, power supply hum, etc.

It is important that we positively identify the half-cycle being viewed on the scope. The first step is to check the polarity or phasing of the scope. Connect the negative side of a battery (1.5-4.5 volts) to the ground terminal of the vertical amplifier. Turn up the vertical gain, then touch the positive side of the battery to the hot vertical input terminal. If the trace moves up, the upper half of an alternating input signal will be positive and the lower half will be negative. If this alternating signal is amplified by a single stage before being fed into the scope, phase will be reversed and the positive half-cycle on the grid of the amplifier will be shown as the lower half of the trace on the scope. Thus, the polarity of the observed signal corresponds to that of the scope only when there are an *even number of stages* between the signal source and the scope.

When the signal to the scope is taken from the secondary of a transformer; e.g., the voice-coil winding, check the phasing of the winding. Apply a positive signal of known polarity to the grid of the stage feeding the transformer and note the deflection on the screen.

Keep the input to the scope low, otherwise the vertical amplifier may overload and distort the trace. When feeding high voltages into the scope, distortion in the vertical amplifier may be avoided by feeding the signal directly to the deflection plates. Before doing this, check the polarity of the plates by using a d.c. source of 20 to 45 volts.

Another method for producing waveform patterns is shown in Fig. 6. This setup differs from that in Fig. 1 in that

A 60-watt output for 100-volt operation should be matched into 170 ohms. The load actually connected is 2,000 ohms. Some amplifiers working into a light load like this will be unstable. To prevent this, a resistance load may be added to absorb the surplus power. In the example suggested, a resistance load to absorb 50 watts would be adequate, and from the chart the value required is 200 ohms. If the amplifier were to be operated continuously at maximum output, this resistor should have a dissipation rating of 50 watts,

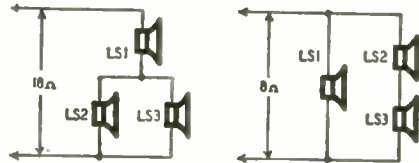

Fig. 2—These hookups give four times as much power to LS1 as LS2 or LS3.

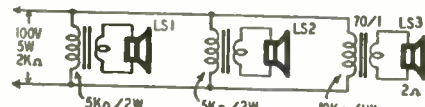

Fig. 3—A constant-voltage line, with the speakers receiving unequal power.

but in practice a much smaller (10- or 20-watt) resistor could be used.

Sometimes the reverse of the previous problem arises. The nominal load connected *exceeds* the power output of the amplifier. Here matters are adjusted by a different method. Suppose the load is made up of a number of speakers rated at 2 and 5 watts for 100-volt line, adding up to a total load of 80 watts. The load impedance of 80 watts worth of speakers will be 125 ohms. The load for a 20-watt amplifier, 100-volt working, would be 500 ohms. Applying a 125-ohm load to the output of an amplifier designed for 500 ohms would probably cut the output down to about 5 watts, and as well likely cause distortion. So

the output must be matched to the actual speaker load of 125 ohms, which, according to the chart of Fig. 4, will give 20 watts at 50 volts, instead of the original basis of calculation, 100 volts. This means the nominal 2-watt speakers, of 5,000 ohms impedance, will get 1/2 watt, and the nominal 5-watt speakers, of 2,000 ohms impedance, will get 1 1/4 watts. Note that this is a reduction of only 6 db, so quite a useful volume will be available, although the amplifier is smaller than one planned for 100 volts. Anyway, if the four-to-one mismatch were used, giving only 5 watts or so, there would be loss of another 6 db, and probably considerable distortion.

Use of the constant-voltage system does not necessarily mean special speaker transformers must be used, so a word about picking suitable transformers from stock lines is needed. Makers of speaker transformers mark them variously in turns ratio or impedance ratio. In the former case the chart of Fig. 5 enables the correct *turns ratio* to be found, but the *actual turns* on each winding must suit the job too. A mike-to-line transformer for a ribbon microphone may have the same ratio of turns as a speaker transformer, but this does not mean that either would do the other's job successfully. A good rule for checking the suitability of speaker transformers with an ordinary ohmmeter is that the winding resistance should be between 2% and 20%, of the impedance for which it is to be used. Less than 2% means its inductance will most likely be inadequate, and 20% or more means the windings will absorb an appreciable portion of the available audio power. If the resistance of the voice-coil winding is too low to register on the ohmmeter scale, the resistance of the high side should be compared with its working impedance. Thus, for example, a winding intended to work at 5,000 ohms should have a resistance that lies

somewhere between 100 and 1,000 ohms

Where transformers are specified by impedance ratio—for example, 7,000 ohms to 3.5 ohms—the maker has stated the *best impedance* at which to work the transformer. Using these impedances, it may be expected to be well over 80% efficient (probably over 90%), and have a good response at low frequencies. But these are not the only impedances at which the transformer can work. The important thing, of course, is that the *ratio* of impedances hold true, so the same transformer could be used for 4,000 to 2, 10,000 to 5 ohms, etc. As stated in the previous paragraph, the losses and response must be kept within bounds. If impedances more than two or three times the rated values are used, the transformer's inductance may prove inadequate. If it is used with impedances less than one-third to one-half the rated values it will become quite inefficient.

A few years ago the author built an amplifier with 50 watts output, using a special multi-ratio output transformer of his own design, provided with matching for load impedances of 8, 12.5, 20, 32, 50, 80, 125, and 200 ohms. It can feed a few high-power units direct, using appropriate matching, but more often it is used for 100-volt line distribution, feeding various numbers of speakers. Up to 50 watts nominal loading, the 200-ohm matching is used. If a greater load has to be fed, a lower impedance matching is selected. The outfit is extremely compact, and on various big PA jobs where the author has used it, many other engineers have been amazed that so small an amplifier, with only 50 watts output, can provide such large coverage. The secret lies in making the best use of the watts available. This is just what correct use of the constant-voltage technique enables the PA man to do.

—end—

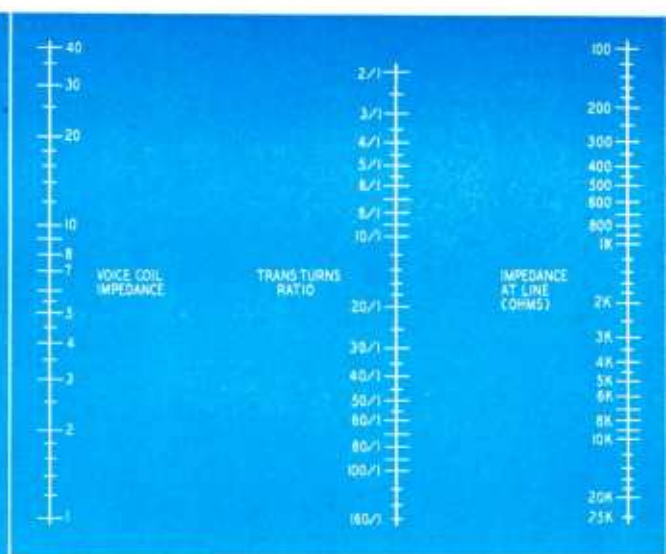
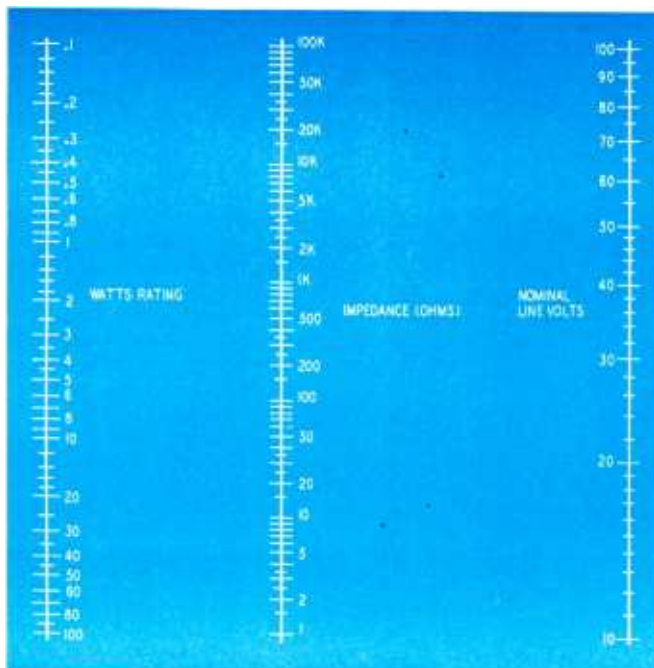

Fig. 4, Left—Constant-voltage chart, showing impedance vs. wattage.

Fig. 5, Right—A chart for obtaining line impedance from turns ratio.

AUDIO WAVEFORM ANALYSIS

By JOHN D. LEDBETTER

THE present demand for high-fidelity audio amplifiers and for better frequency response in the older units has placed the service technician in the role of "service engineer" rather than repairman. Not only is he required to service high-quality audio and sound systems, but he is often requested to improve and modify amplifiers with a poor frequency range. The frequency response of most amplifiers, provided their basic design is good, can often be considerably improved.

Modern test equipment necessarily plays an important part in this new "engineering" role.

Sine wave testing

Distortion, frequency response, overloading, etc., in the audio system can be checked with the following aids: (1) sine waves, (2) square waves, and (3) sweep-frequency records. The first method (illustrated in the setup in Fig.

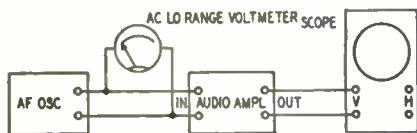

Fig. 1—Checking sine waves with scope.

1) consists simply of a variable audio oscillator and a scope. The oscillator feeds a signal into the amplifier, and the scope (across the amplifier output) indicates what has happened to the audio sine wave as it passed through the amplifier. The low-range a.c. or output meter connected across the audio oscillator output should read the same value of signal input for all applied frequencies.

Let us examine some of the waveforms which can be obtained with sine wave testing. We are familiar, it is assumed, with the sine waveforms shown in Figs. 2-a and 2-b. Suppose that a sine wave similar to that in Fig. 3-a is present at the output, *even though no signal is being fed into the amplifier input*. A logical assumption is that a.c. hum is being picked up at some point in the amplifier. Determine the frequency of the waveform by adjusting the scope frequency control until a single stationary cycle as in Fig. 2-a is obtained; then read the frequency

setting on the scope sweep control. If the frequency is 60 cycles, look for cathode-to-heater leakage in one of the tubes, or stray pickup from the filament leads, power transformer, or some external source. If the hum frequency is 120 cycles, an open or low-valued filter capacitor is indicated.

Sometimes a wide, blurred waveform may appear at the output instead of the usual thin, well-defined line. Such indication is caused by oscillation within the amplifier. *Low-frequency* feedback resulting in oscillation may be due to open plate or screen-grid bypass capacitors or to inadequate decoupling between stages. *High-frequency* oscillation may be the result of defective plate or cathode bypass capacitors, or to regeneration in one or more stages. An open plate bypass capacitor in the output stage, and output leads which are too close to the amplifier input circuit can be notorious offenders in this respect. This condition is often caused by improperly shielded grid circuits in high-gain amplifiers, or by plate and grid leads placed too close to each other. Shielding all grid and low-level leads, and properly dressing grid and plate leads almost invariably corrects this latter condition.

The waveform in Fig. 3-b is the result of modulating a 60-cycle sine wave with 400 cycles. Typical distorted waveforms are shown in, Figs. 4 and 5. Note that the relatively small amount of distortion in Fig. 4-a results in clipping of the positive peaks only, while the high distortion shown in Fig. 4-b has flattened both positive and negative peaks. Positive peak flattening is usually due to overloading or insufficient bias. Negative peak flattening can be caused by a shorted cathode bypass capacitor. The waveform in Fig. 5-a (note the distorted negative peaks) is a typical example of distortion caused by overloading. Fig. 5-b indicates presence of regeneration *and* overload. The terms positive and negative peaks are applicable literally only when checking the waveform at the plate of a particular stage. The usual stage-by-stage checks should be employed to determine the source of distortion. First, be sure that the distortion is due to a defect within the amplifier and *not* from excessive input from the signal generator. Connect the scope's vertical leads suc-

cessively across the plate and grid circuits of each stage, beginning with the output stage and working back toward the input until the distorting stage is located. If distortion as indicated by these scope checks suddenly disappears you can be certain that its source has just been passed. Don't forget to check the compressor, expander, and phase inverter circuits. In most cases you will find that the distortion is caused by defective tubes, leaky, open or shorted capacitors, improper grid bias, incorrect plate voltage, resistors that have changed in value, power supply hum, etc.

It is important that we positively identify the half-cycle being viewed on the scope. The first step is to check the polarity or phasing of the scope. Connect the negative side of a battery (1.5-4.5 volts) to the ground terminal of the vertical amplifier. Turn up the vertical gain, then touch the positive side of the battery to the hot vertical input terminal. If the trace moves up, the upper half of an alternating input signal will be positive and the lower half will be negative. If this alternating signal is amplified by a single stage before being fed into the scope, phase will be reversed and the positive half-cycle on the grid of the amplifier will be shown as the lower half of the trace on the scope. Thus, the polarity of the observed signal corresponds to that of the scope only when there are an *even number of stages* between the signal source and the scope.

When the signal to the scope is taken from the secondary of a transformer; e.g., the voice-coil winding, check the phasing of the winding. Apply a positive signal of known polarity to the grid of the stage feeding the transformer and note the deflection on the screen.

Keep the input to the scope low, otherwise the vertical amplifier may overload and distort the trace. When feeding high voltages into the scope, distortion in the vertical amplifier may be avoided by feeding the signal directly to the deflection plates. Before doing this, check the polarity of the plates by using a d.c. source of 20 to 45 volts.

Another method for producing waveform patterns is shown in Fig. 6. This setup differs from that in Fig. 1 in that

A fundamental method of tracking down and coping with the many ills that beset the amplifier is presented in this article. Goal: high fidelity.

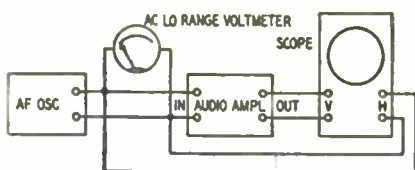

Fig. 6—Setup for checking phase shift.

the horizontal sweep voltage is obtained from the audio oscillator instead of from the scope's internal sweep. The resultant pattern with a normally operating amplifier in this setup would be a thin 45-degree line (Fig. 7-a). This method *must* be used to determine the amount of phase shift in an amplifier. This method offers several advantages over the Fig. 1 setup when checking for distortion and overload. For example, a small amount of distortion hardly enough to produce the "clipping" action in Fig. 4-a would produce the pattern in Fig. 7-b. The distorted condition in Fig. 4-b would likewise appear as shown in Fig. 7-c. Phase shift of 45 degrees is shown in Fig. 7-d. (It might be noted here that phase shift up to about 30 degrees can be tolerated in an audio amplifier provided the phase shift is the same, or nearly so, for all frequencies). To check this, feed a 1,000-cycle signal into the amplifier and note the degree of phase shift. The phase shift pattern should not vary more than 30 degrees from this value over the rest of the audio frequency range.

Square-wave testing

The main advantage of square-wave testing is that phase, distortion, and frequency response characteristics of an audio amplifier can be observed at the same time. The setup in Fig. 1 can be used except that a square-wave generator is substituted for the regular audio oscillator. If no square-wave generator is available, the regular audio oscillator may be used by adding a simple twin-diode (such as the 6H6) in its output circuit and biasing it to operate as a limiter. Experiment with the bias by feeding a sine wave through the limiter and adjusting the bias until a pattern similar to Fig 8-a is seen on the scope.

The square wave shown in Fig. 8-a is an unattainable ideal. The wave form of Fig. 8-b indicates a certain amount of distortion, accompanied by a drop in low-frequency response. Fig. 8-c shows

advantages when used for audio design or replacement work. The effect of volume controls, tone control and feedback circuits, filters, etc., on frequency response, phase, harmonic distortion, and other factors can be readily observed on the scope screen.

Frequency response

There are several methods of measuring frequency response characteristics. One of the simplest is to use a variable audio oscillator with a db meter (instead of the scope) connected across the output of the audio amplifier. As the audio oscillator is varied slowly from about 30 to 10,000 cycles (with its output kept constant as indicated on the low range a.c. voltmeter), the amplifier response can be read directly as + or - db on the output meter. If no db meter is available, the scope can be used as a response indicator. Simply turn off the horizontal amplifier, so that only a thin vertical line appears on the screen. (This line represents the amplifier output). Adjust the height of the line to cover any desired part of the screen at a certain reference frequency (usually 1000 cycles). Then vary the audio oscillator as above and note whether the vertical line decreases or increases in length. A 50% change indicates a corresponding drop or gain of 6 db. A drop of this amount would indicate the practical limit of response at that particular end of the band. (First check the linearity of the scope's response over the frequencies to be measured by connecting it directly to the a.f. oscillator output.)

Hum originating in the power supply can be traced with a 600-volt, 1- μ f capacitor in series with the scope lead to the vertical circuit and probed to points in the power supply. The amplitude of the 60- or 120-cycle sine wave at these points will indicate the effectiveness and condition of each filter component.

Much more can be said on waveform analysis of audio amplifiers. The examples cited, however, should serve to stress the importance of proper interpretation of all types of wave patterns. Lissajous figures are very helpful in determining frequency and phase relationships between several waves but were not treated in this article due to the length of time and space which would have to be allotted in a fair discussion. It might be said in passing, however, that their use in amplifier and receiver servicing is going to be more and more important as the art of audio servicing advances. Fig. 7-a and 7-d are Lissajous patterns denoting a phase shift of 0 degrees and about 30 degrees, respectively. Fig. 11-a shows a phase shift of 90 degrees; 11-b denotes 45 degrees. Fig. 11-c indicates a frequency ratio (vertical plates to horizontal plates) of 2:1; in Fig. 11-d the ratio is 3:1, and in 11-e it is 1:3. (The ratio can be determined by tracing out the pattern and counting the number of vertical loops as compared with the horizontal loops.)

—end—

ELECTRONICS and MUSIC

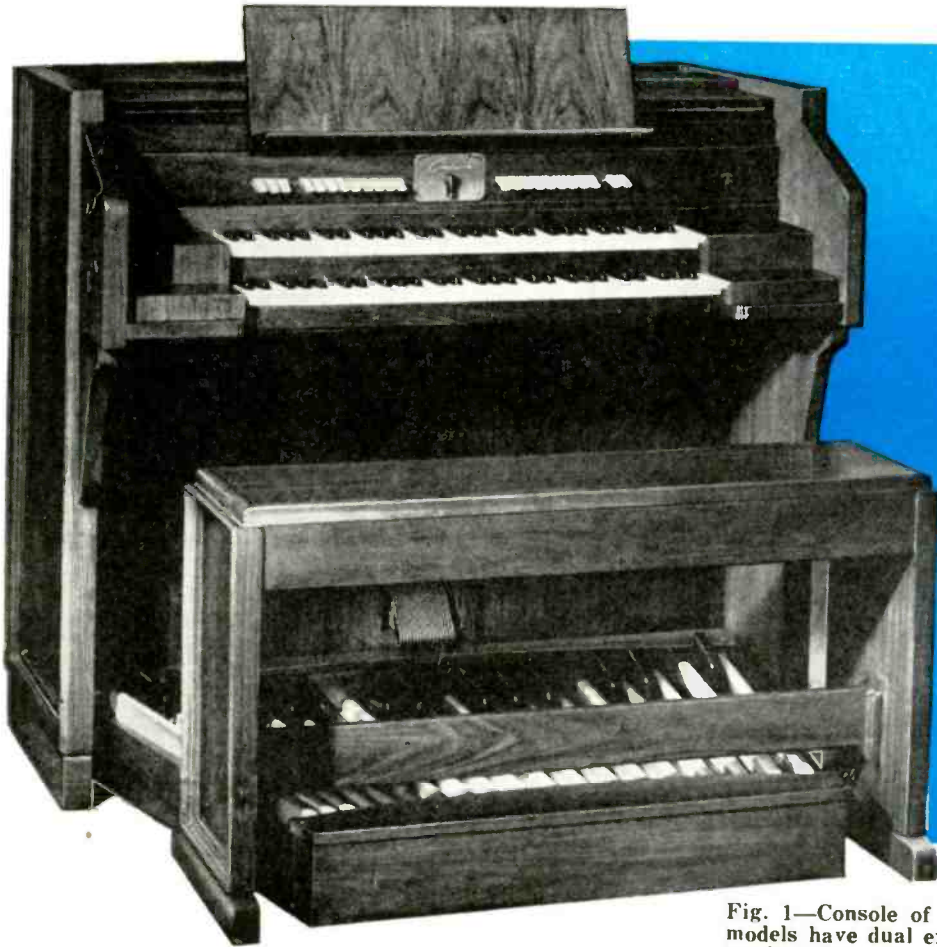

Part XX—First half of a discussion of the Connsonata—overall description and oscillato circuitry

By RICHARD H. DORF*

Fig. 1—Console of the Model 2C Connsonata. Other models have dual expression pedals and varying stop combinations, as well as different switching systems.

THE Connsonata, made by C. G. Conn, Ltd., of Elkhart, Indiana, a firm which for many years has been famous as a manufacturer of band instruments, is basically different from most electronic musical instruments in that it does not include any frequency dividers or multipliers or locked-in octave chains. Each note is generated by a separately tuned, individual L-C oscillator, which results in something of a chorus effect not possible in instruments in which the phase relations between octavely related notes are fixed.

Several Connsonata models are made, all operating on the same principles but

with variations in switching methods and tonal resources. Fig. 1 is a photograph of the console of model 2C, which has great and swell manuals, each of 61 notes, and a 32-note radiating pedal clavier. The 2C has a single expression pedal, 12 "voices" (corresponding to stops), and seven couplers for actuating the voices of one department with the keys of another and for bringing in 16-, 8-, 4-, and 2-foot registers. The technical description which follows does not necessarily apply entirely to the 2C but is a general description of the salient features of most of the Connsonata models.

Fig. 2 is a block diagram which illustrates the general sequence of oper-

ations in the Connsonata. The swell manual circuitry contains 61 oscillators, each of which may be keyed by a grid-bias system. Each key has several contacts which key the oscillators in the various registers, the registers being selected by couplers.

The outputs of all oscillators of the swell manual are integrated by a series-connection network which allows the output of each oscillator to be regulated at installation time for correct voicing or output levelling. Each oscillator provides two outputs, one a sine wave and the other a pulsed waveform; thus there are two summations for the swell department. These go into mixers which include frequency discriminating networks and amplifiers to produce the voices or tone qualities corresponding to stops. The outputs of the mixers for the swell manual are commoned (paralleled) and fed to a one-stage booster amplifier.

The great manual and the pedal clavier operate in the same way, but independently, except that two of the four pedal boosters are commoned and fed to one section of a dual-expression control whose other section controls the output of the swell booster. The other two pedal mixers are fed to a dual-expression pedal associated with

*Audio Consultant, New York City

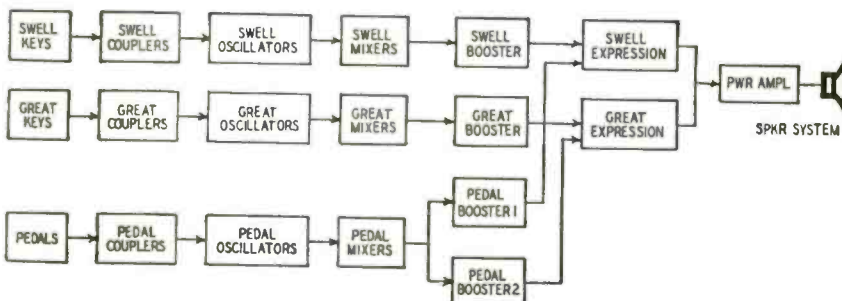

Fig. 2—Representation of the sequence of operations in the Connsonata system.
FEBRUARY, 1952

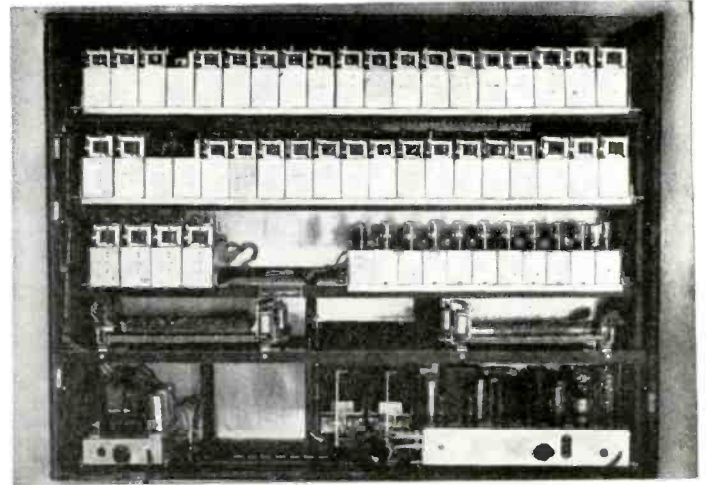
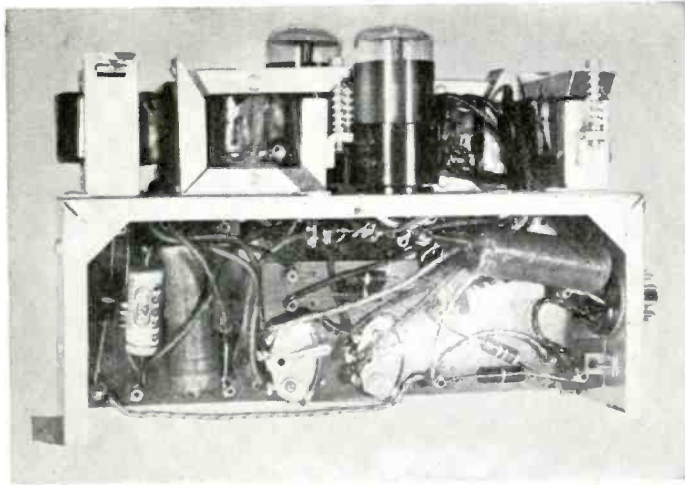

Fig. 4, left—This oscillator chassis generates four tones in the Model 2A2. Fig. 5, right—Rear view of a Connsonata shows how oscillators, power supply, boosters, preamplifier, coupler relays, and power amplifier are mounted inside the console.

the great booster. On models with separate great and swell expression pedals, each pedal also controls a part of the pedal volume.

The outputs of all the expression pedal sections are commoned and led to a power amplifier and loudspeaker located in a separate cabinet.

Oscillators

One of the oscillators used in the Connsonata is diagrammed in Fig. 3. There are four each on most of the oscillator chassis. They are simple L-C units, each using one half of a 12AH7-GT dual triode, so that there are two tubes on a generator chassis such as the one pictured in Fig. 4.

The grid of the oscillator is normally connected through series 470,000- and 100,000-ohm resistors to a negative bias supply whose voltage is sufficient to cause plate-current cutoff. When a manual key is pressed it closes a key switch which grounds the junction of the resistors, grounding the grid for d.c. and unblocking the tube without appreciably loading the bias supply. The tremolo switch may be set to ground the grid when the key is pressed or (as

shown in Fig. 3) it may be set to impress a small low-frequency voltage from a tremolo-frequency generator on the grid so that the tone varies in both volume and pitch at a tremolo rate.

Two outputs are taken from each oscillator. The output from the secondary of the tuning transformer is approximately a sine wave. Each secondary has a potentiometer across it and the potentiometer arms and one side of all the windings are connected in series as shown. Seventy-three of these flute outputs are connected in series in this way and the sum of the 73 tones is connected to all the flute-type tone-shaping circuits in parallel, as shown later.

The cathode output has a pulse wave-shape. The cathodes of all four oscillators on each chassis are commoned and the cathode line from each chassis is connected to a resistor bus, with small resistances between each two chassis for isolation. The summed cathode tones are fed to a matching transformer primary, with the transformer secondary feeding all the string-type tone-shaping circuits.

All the oscillators in the instrument have similar circuitry, except that some

do not include the paralleled resistor and capacitor between the transformer center-tap and B-plus. Unmarked-value components are those which vary from one oscillator to another for tuning purposes. There is no real provision for gradual attack in keying, but this particular oscillator has very good keying characteristics, including lack of chirp and a slight delay which softens any clicks and makes them inaudible. Several patents on different forms of this oscillator are owned by Conn. The writer judges, from hearing the Connsonata, that the attack is approximately similar to that of the Hammond organ.

Fig. 5 shows the back of the console of a Connsonata with banks of oscillator chassis similar to that in Fig. 4. The oscillators are tuned by adjusting the position of the closing portion of the core laminations across the E frame. The adjustment is plainly visible in Fig. 4, with its spring-loaded screw.

The model 2C pictured in Fig. 1 has slightly different circuits and does not have separate oscillator chassis. The rear of the model 2C is shown in Fig. 6. The tubes are miniatures.

(to be continued)

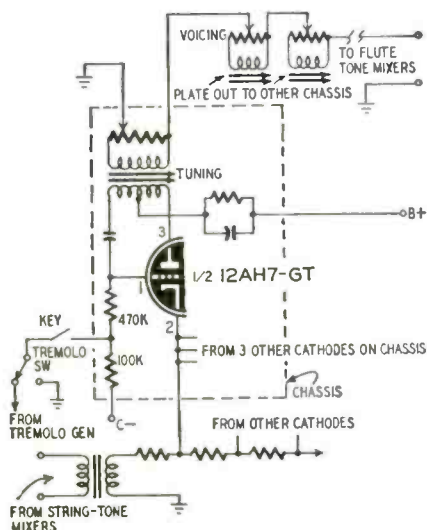

Fig. 3—Connsonata oscillators are of this type. Keying characteristics are good.

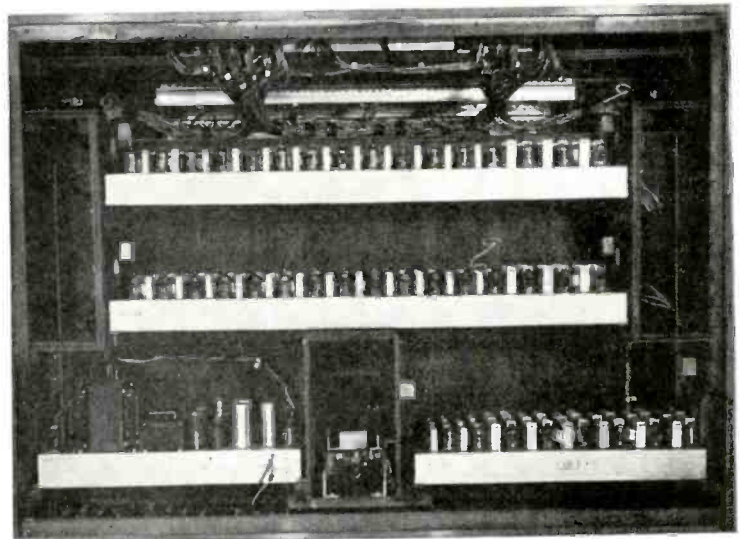
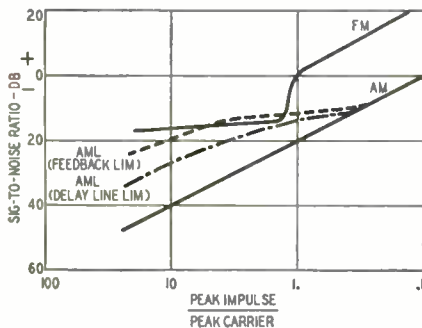

Fig. 6—A back of the Connsonata shown in Fig. 1. Miniature tubes are used.

FM Wins in British Tests

By RALPH W. HALLOWS

WRITING of the British tests of FM *versus* AM, in the October, 1951, issue of this magazine, I predicted that the BBC's report would be a very important document when it came. It is all that. It is a completely unbiased account of the results of the most thorough comparative tests ever made. And it settles once and for all the question behind the most heated controversy in the history of radio: For v.h.f. broadcasting FM is overwhelmingly superior to AM. FM deals much better with interference. For a given output power the service area with FM has a radius *nearly twice as great*. A high-fidelity FM receiving outfit need cost little if any more than an



Graph of results of laboratory test.

AM receiver. It is no harder to tune or maintain than the AM receiver.

A word about the tests themselves. At a site about 25 miles southeast of London a specially built station was equipped with AM and FM transmitters, each with a carrier power of about 20 kilowatts. These worked simultaneously into a slot antenna array 1,100 feet above sea level. The AM frequency was 93.8 mc and the FM 91.4.

In addition to laboratory and field tests by their own engineers, the BBC provided a large number of listeners—technical and nontechnical—with receiving equipment. Each listener sent in regular reports in the form of answers to questionnaires. The transmissions started in July, 1950, and the report is based on nearly a year's working.

Laboratory tests had shown that there was very much less receiver hiss with FM than with AM. This was fully confirmed by listeners. With a simple dipole antenna a well designed receiver on the average required a field strength no greater than 50 microvolts per meter to make hiss barely noticeable with FM. To produce the same effect with AM called for 1,000 microvolts.

Receiver hiss is critical particularly as its level is increased by the wide pass-band needed by high fidelity; but much more so is the impulsive interference due to automobile ignition systems. The graph shows the results ob-

tained in the laboratory. (AML stands for AM receiver with limiter.) The most important parts of the curves are those where the peak-impulse-to-peak-carrier ratio is greater than unity, because it is there that ignition interference is most annoying. Though there is a sharp fall in the effectiveness of FM from the point at which the impulse is of equal strength with the carrier to the point at which it has a little more than twice the strength, the curve levels out again. Over the whole range of signal-to-noise ratios FM is much better than AM, though AM with a feedback limiter runs about even with it for some distance.

Subjective tests employing actual listeners at receivers, and motor cars to create interference slightly exaggerate the results of practical experience, FM is at all points much better than AM or AML. In terms of field strength it was found that where x microvolts per meter was needed with FM for auto ignition interference to become negligible, AM required $10x$ microvolts to produce a comparable effect.

To enable the results to be adequately assessed and to be used for planning a nation-wide v.h.f. broadcasting service the BBC evolved a "standard listener" and worked out how he could be provided with a "standard service." The standard listener uses a simple type of antenna within 30-60 feet of a road carrying a full stream of traffic. He (or she) has good hearing and finds interfering noises objectionable if they are more than occasionally noticeable. Two grades of standard services are suggested:

1. First class. No perceptible interference from at least half of the automobiles that pass the house. No ignition system to produce more than slightly annoying interference, and such interference to be very occasional.
2. Second class. Interference from half of the passing vehicles to be no worse than perceptible. Only occasional cars to cause annoying interference.

The table shows the field strengths required with FM, AM, and AML to give the standard listener a first-class or a second-class service. Not much doubt, I think, about which system is going to do the job best! FM needs a field strength no greater than 1 millivolt per meter to insure a first-class

service or $\frac{1}{4}$ millivolt for a second-class service—and even the latter is pretty good. To serve the standard listener as well AM must have field strengths from 10 to 12 times as great. With a given output power an FM transmitter has nearly double the range of an AM one.

If you double the range of a transmitter, its service area becomes not twice but four times as great. Hence the number of FM stations needed for nation-wide coverage of Britain—or any other country—with a v.h.f. service is only about one-fourth of those that would be required in an AM system. Think of the saving in capital outlay!

The report contains several surprises. One of these is that the bogey of increased cost raised by those who oppose FM becomes a myth. It's true that the receiving set may be somewhat (though not much) more expensive than its AM counterpart. But this is largely—if not entirely—offset by the much lower price of the antenna needed to make certain of good reception. In fact, it was found that a very large proportion of listeners living within 30 miles of the transmitter could obtain all they wanted from the simplest of indoor antennas. At greater distances the smaller field strength required for good FM reception always means that the antenna is simpler and less expensive than a comparable AM antenna.

Surprise No. 2 really is a surprise! It has been stated again and again that the biggest point against the successful use of FM by the ordinary listener was that he would never be able—or would never bother—to do the accurate tuning necessary. We were assured that if the FM receiver were the smallest bit off tune, results would be horrible. Visiting the homes of non-technical listeners, BBC engineers have found that their slightly incorrect tuning of a v.h.f. FM receiver produces no worse effects than the same kind of inaccuracy does on the broadcast band.

It has been impressed on us by the anti-FM-ites that oscillator frequency drift must be fatal to good reception, unless the receiver incorporates such refinements as crystal control or automatic frequency control. For all that, the tests have shown conclusively that simple and inexpensive sets, with no such luxury fitments, give no trouble once they have warmed up a few minutes after being switched on.

—end—

System	First-Class Service Area		Second-Class Service Area	
	Field-strength (uv/m)	Miles Approx. Range	Field-strength (uv/m)	Approx. Range (Miles)
FM	1	45	0.25	60
AML	3	35	1	50
AM	10	25	3	35

Operating TV

Part I—Theory and operation of the camera and optical equipment found in the average TV studio

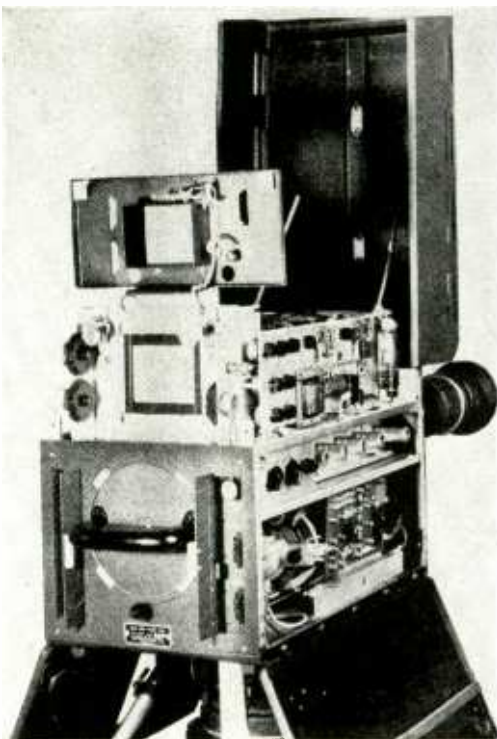

Standard TV camera, seen from rear.

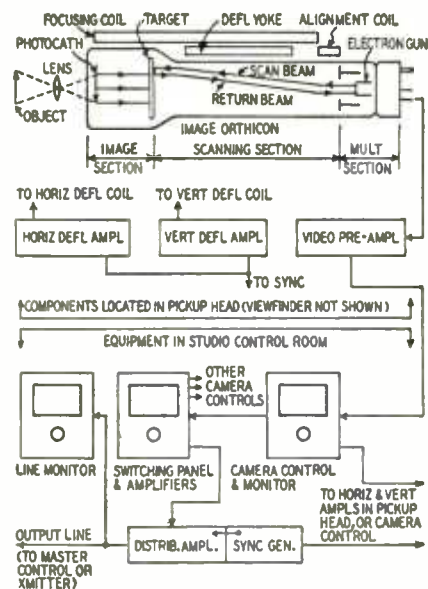

Fig. 1—Camera setup, block diagram.

NEARLY all trade schools and universities are stressing TV training to meet the need for broadcast personnel with some grounding in TV operation. There is tremendous interest in the field of television broadcasting among all who are connected with any of the varied branches of radio and TV, and among many who are looking forward to entering the broadcast field.

Strictly aural broadcasting, AM or FM, is an admittedly simple operation compared to TV broadcasting. It is a challenge to every man, either now in TV broadcasting or contemplating getting in, to understand the multitude of operations involved in this complex job in such a way as to do justice to the finely engineered equipment which is put at his disposal.

TV slanguage

Television has a slanguage all its own. It is a mixture of terms from radio, newspaper, movie lot, and theater, with some new ones peculiar to TV. *Panning* is not what we do to our mothers-in-law, but the act of sweeping a scene by swinging the camera to right or left. A *pedestal* is not the base you put your Ming vase on, but the d.c. level upon which the video signal is superimposed. The d.c. pedestal ampli-

tude sets the average brightness of a scene.

An *inky* is an incandescent lamp. *Ike* is the iconoscope tube used in televising film; it is also used, though rarely, in some studio pickups. Most studio and field cameras use the super-sensitive image orthicon which is not only more sensitive than the iconoscope, but gives a far better picture with fewer electronic adjustments.

Equipment

For clarity, Fig. 1 illustrates the equipment with which the studio operator is most directly concerned.

The pickup head includes the image orthicon tube, associated video pre-amp, horizontal and vertical sweep circuits and deflection coils, focus coil and alignment coil, and blanking-pulse circuits (negative pulses to shut off scanning beam on retrace periods). Mounted on top of the pickup head is the electronic viewfinder and associated circuits which show the camera operator exactly what the picture looks like at the output of his pickup head. Some viewfinder tubes (optical type) show about 20% greater field of view on all sides than is actually covered by the pickup tube and lens assembly. This gives the operator a chance to see beforehand what a *pan* of the camera

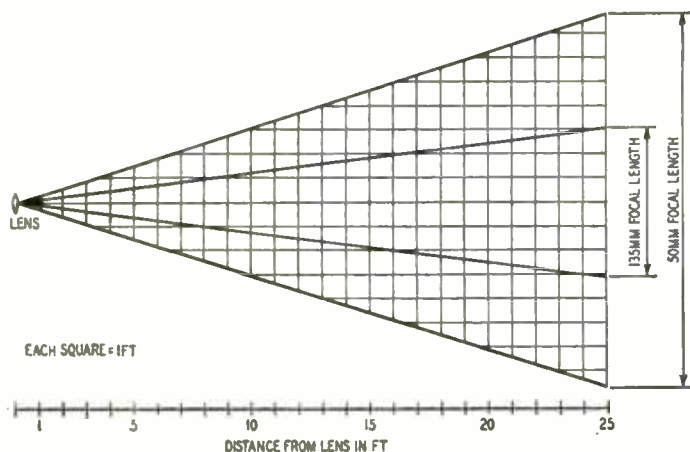
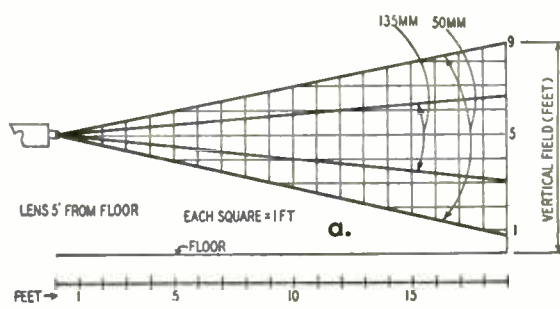

Fig. 2, left—Field width of 135 and 50 mm focal length lens, showing the area covered at various distances from the camera.



Studio Equipment

By HAROLD ENNES



Control position. Left, the audio; center, technical; and right, the program director.

will cover without removing his face from the hood of the viewfinder. The actual transmitted picture area is marked off with black lines on some viewfinder monitor tubes. The photograph illustrates a typical camera and viewfinder assembly (the upper section) with all doors opened to reveal the parts and tubes.

The viewfinder is detachable from the pickup head, and is usually removed when shipped or transported for any distance. On portable type equipment, the operator must beware of picking up the whole assembly by the handle on top of the viewfinder. The equipment is expensive.

The pickup-head sweep-circuit pulse formers, blanking-pulse generators and focus-coil current are usually initially adjusted through the camera-control unit in the control room. Initial adjustment of camera characteristics requires close co-operation between camera operator and camera-control-unit operator. There is one camera-control unit for each camera, but two camera-control units may be operated by one experienced TV operator if it becomes necessary.

Omitted in Fig. 1 is the vital intercom system that enables the producer, technical director, cameramen, and soundmen to co-ordinate their various activities.

The camera warmup period

Before the director can start barking his commands, "Take number one" and "Dolly in number two," the equipment must be checked and readied for service. No member in the entire setup can be more important than the cameraman. It has become obvious through the recent years that even with benefit of the most gifted of program directors, success cannot be achieved without a camera operator who knows his camera, lens, picture composition, depth of focus, and over-all operating technique. The director must know what he wants, but the cameraman must be able to achieve it by camera movement, choice of lens, lens iris adjustment, or camera operating characteristics adjustments. To the experienced operator, the warm-up period, or initial adjustment period, is an important phase of satisfactory performance.

A brief outline of the equipment warmup period follows:

1. All equipment is usually turned on 30 to 60 minutes before rehearsal or on-air program. The image orthicon camera contains both a heating element for the tube and a cooling blower for ventilation. The tube will warm up from ambient temperature in about 30 minutes. If time is short the heater may be turned on. The electrical re-

sistivity of the target in the image orthicon is dependent upon temperature, decreasing rapidly in value as temperature rises. Correct operating temperature of the target in the 2P23, 5769, and 5820 is 35° C. Top limit is 65° C. For the 5655, a popular studio-type tube, a 45° C temperature is optimum.

2. Camera alignment and focus checks (involving both camera operator and camera-control operator).

3. Horizontal and vertical sweep checks.

4. Check of program continuity with director, determining camera placements and choice of lenses and iris openings.

5. Final camera-control and mixer-panel adjustments.

6. Check of film or slide equipment.

7. Check of sound channels and intercom circuits.

8. Check through to master control or transmitter.

Camera alignment and focus

Alignment and focus checks are usually the first. Adjustments are not attempted until the equipment has been turned on for at least 30 minutes, with the camera lens capped to prevent any light from falling on the photocathode.

The scanning beam is aligned by regulating the current through the alignment and focusing coils (see Fig. 1). The deflection coils constitute a rotatable yoke around the neck of the image orthicon tube. Focus and alignment currents are supplied from the control room. The camera, however, includes a potentiometer used to fix the magnitude of the alignment currents. This pot, on the Du Mont pickup head, is the lower right-hand control.

For correct alignment, the operator first adjusts the *focus-coil current* to the value recommended by the manufacturer. Du Mont and RCA cameras use 75 ma for the focus coil. Alignment is facilitated by rotating the yoke with respect to the tube, and adjusting the *alignment-coil current*.

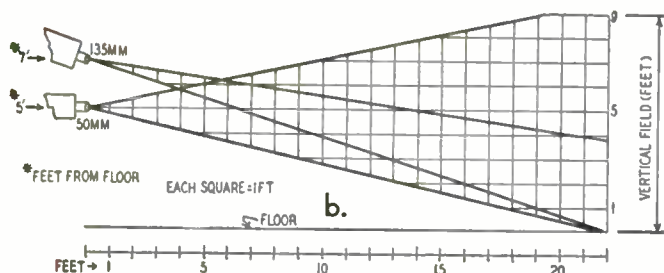

Fig. 3 (a and b)—The vertical field covered by the camera, straight and tilted.

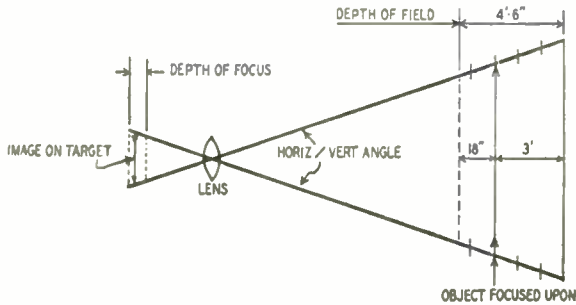

Fig. 4—Depth-of-field diagram, showing difference in field depth before and behind the point of exact focus.

Current through the yoke is supplied from the regulated focus-field power supply. The magnitude of this field is controlled by the alignment potentiometer, and its direction by rotating the yoke. The tube is fixed in position, being installed with white line on front of tube down, and white line on rear of tube up.

Alignment adjustment is used to correct electrically any slight mechanical misalignment of the electron gun with the longitudinal axis of the tube. The electron beam is out of alignment if the picture as viewed on the viewfinder screen or control-room-unit monitor rotates when the orthicon focus voltage, is varied. The optimum value for both Du Mont and RCA cameras is approximately 180 volts for orthicon focus, and 450 volts for image focus.

If a camera is found out of alignment, the camera operator first sets the alignment current potentiometer to zero (no current) and gradually increases this current while the yoke is rotated for optimum beam direction. Operators cap the lens to prevent light from falling upon the photocathode (when an adjustable iris diaphragm is used, it may be closed in some instances) and observe the "multiplier spots" appearing on the electronic viewfinder screen. A certain setting of the potentiometer and position of the yoke will be found where these spots will stand still when the orthicon focus control is varied—they will go in and out of focus in response to this control.

The lens is now uncapped (or iris diaphragm opened) and the camera is trained upon a test pattern or studio scene. The picture will go in and out of focus without tilting the picture when the orthicon focus control is varied.

What lens?

Lighting, scene composition, and scenic effects desired determine the type of lens and respective iris adjustments. With the 5655 image orthicon, often used in studios, a scene illumination of 100 to 250 foot-candles is adequate in most instances. With the newer 5820 tube, about 65 foot-candles is adequate. The 2P23 and 5769 image orthicons, popularly used in field telecasts, will operate on 15 to 30 foot-candles. Picture quality from these tubes is not

quite equal to the 5655 or 5820 signal, but a tube sensitive to the light of a match and even to infra-red rays holds an important niche in modern TV.

Lens turrets are used on all modern TV cameras, enabling the camera operator to select a different lens by simply turning a handle on the rear of the pickup head.

TABLE I

TABLE OF LENS ANGLES (When used with image orthicons)		
Lens	Horizontal Angle	Vertical Angle
35 mm (1½ in.)	50°	38°
50 mm (2 in.)	34°	25.5°
90 mm (3.5 in.)	19°	14°
135 mm (5.3 in.)	13°	10°
8½"	8°	6°
13½"	5°	3.7°
17"	4°	3°

In practice lenses vary from the 1.4-inch wide-angle lens to the 17- or 25-inch telephoto lens used in field events. In studios, the most popular sizes are: 50-mm (2-inch), 90-mm (3.5-inch), 135-mm (5.3-inch), and 8½-inch.

The width of field is the usable horizontal range of a lens, and is related to the focal length of the lens. Fig. 2 shows the comparison of the width of field for a 50-mm (2-inch focal length) and a 135-mm (5.3-inch focal length) lens. Each square represents one square foot. Ten feet from the camera lens, the width of field for the 50-mm lens is 6 feet, and is approximately 2½ feet for the 135-mm lens. Since either one will fill the picture screen, the image will be larger for the 135-mm lens, but obviously will cover less of the scene area. Thus a given camera may cover a wide angle of this particular area, or a close-up of a part of it, by using a lens turret.

Actually the above graph and Table I apply only for cameras using image orthicon tubes, now used in almost all studio cameras. The width of the photocathode in this type is about 1.2 inches. For a given lens size (focal length) the iconoscope whose mosaic is about 5.3 inches wide provides a much greater field of width than does an image orthicon.

The required illumination, however, is tremendously increased. Also the picture is not nearly as satisfactory as the more sensitive image orthicon provides. Due to size of the mosaic the iconoscope is limited to lenses whose focal lengths are not less than 5 inches.

Fig. 3-a and 3-b indicate the vertical angle of two lenses: the 50-mm (2 inch) and 135-mm (5.3 incl.). Fig. 3-b shows effect of height and tilt of camera. For example, a camera with a 50-mm lens 5 feet from the floor will cover a vertical field of approximately 10 feet at a distance of 22 feet from the camera. The second camera with the 135-mm lens, could be placed 7 feet high (crane or pedestal operation) to cover a close-up (a little over 3½ feet) of the scene from the floor. This angle would present a slightly "above" scenic effect, and is illustrated here as only one of a great number of possibilities.

Fig. 3-a shows the same two vertical angles from a given point above the studio floor.

As in the explanation of Fig. 2, this data applies only for cameras employing the image orthicon type tube.

In explanation of Fig. 4:

Depth of field is defined as follows: "The distance between the nearest object to the lens in focus and the farthest object from the lens in focus when the lens is focused on a given point." The depth of field defines the area in front of and behind the main object plane. In practice, the depth of field is almost twice as great behind the object focused upon as in front of that object.

Depth of focus is defined as follows: "The distance between the nearest image to the lens that is in focus and the farthest image from the lens that is in focus when the lens is focused on a given object." The depth of focus relates to the pickup head itself.

Fig. 5 illustrates the optical configurations required to understand these terms.

A good cameraman is thoroughly familiar with his lens characteristics. When he gets instructions through his headphones via intercom, "Number two camera—take right of sofa—bust shot of woman—" he knows exactly what to do.

Table I shows typical horizontal and vertical angles of specific TV lenses. These values vary slightly with different makes. An excellent exercise for the TV student is to cut cardboard triangles corresponding to the horizontal and vertical angles of the lenses mentioned in Figs. 3 and 4 and Table I. On large-size linear graph paper, the operator can plot his studio dimensions (or active area of studio) to scale. The student can choose arbitrary dimensions, such as 40 x 60 x 30 feet. Using the basic suggestions from Figs. 3 and 4, a clear relationship may be pictured between lens size, position, and height, and the projected area that may be covered. After considerable practice these factors are instinctively balanced in the every-day routine of telecasting.

(to be continued)

Algebra in Electronic Design

By EDMUND C. BERKELEY

IN OUR previous article, "Light Sensitive Electronic Beast," we talked about Squee and about Boolean algebra, and introduced the ideas and rules of Boolean algebra. We said that Boolean algebra had a number of important applications in the design and simplification of circuits, and that it was used in the design of Squee and proved very useful. Some of the use of Boolean algebra in the design of Squee will be given in this article; but unfortunately there will be no space here to give all the construction information for Squee. However, we shall be glad to try to help any reader who wants to learn about or construct Squee (or other small robots).

What is Boolean algebra?

In the last article we gave three interpretations of Boolean algebra: classes of things; factors of a number such as 30; and relations of contacts of switches or relays, as shown again in Fig. 1 here.

What are a, b, and c in Fig. 1? They are not actually contacts or wires; they stand for states, conditions, or reports about contacts or wires. They stand for reports such as "Current flowing" or "No current flowing." They always have just one out of two values, such as *yes* or *no*, *all* or *nothing*, *true* or *false*, *1* or *0*. They are called *binary variables*, variables which have only two values. Any letter labeling a contact or a wire has the value 1 if its contact is energized or closed or if its wire is carrying current. It has the value 0 if its contact is open or not energized, or if its wire is not carrying current. Contacts are always drawn in the unenergized (double-contact relays) or open (single-contact relays) position. This is referred to as the "not" position and is written a', b', etc.

The algebra of 1 and 0

This leads us to a fourth interpretation of Boolean algebra that is most important for our purposes. This is the algebra of propositions or statements. Suppose that P, Q, R stand for propositions or statements such as "Motor A is on," "Photocell B registers light," "Relay C is energized," etc. Let T(...), where the space ... is filled with a statement, stand for the "truth value of ...," equal to 1 if the statement is true and 0 if the statement is false. Then the 1's and 0's of truth values are a Boolean algebra.

We write $T(P) = p$, $T(Q) = q$, $T(R) = r$. In other words, a convenient abbreviation for the truth value of a statement represented by a capital letter is the corresponding small letter.

Now it can easily be shown that the following rules hold:

$$\begin{aligned} T(P \text{ AND } Q) &= p \cdot q \\ T(P \text{ OR } Q) &= p \vee q = p + q - pq \\ T(\text{NOT } - P) &= p' = 1 - p \end{aligned}$$

In the form of tables, we can list all the cases:

I		II		III		
p	q	p · q	p ∨ q	p + q - pq	p	p' = 1 - p
0	0	0	0	0 + 0 - 0	0	1
0	1	0	1	0 + 1 - 0	1	0
1	0	0	1	1 + 0 - 0	1	0
1	1	1	1	1 + 1 - 1	1	0

How do we convince ourselves of these tables and formulas? Let us first ask "When is the statement P AND Q true?" Now we know from our use of AND that this is only true if P is true (p = 1) and Q is true (q = 1). The table shows 1 for p · q only in that case. That is what we mean by AND when we put it between statements.

By OR we ordinarily mean "... OR ..." OR BOTH." Sometimes we mean OR ELSE; but in the connection of switch and relay contacts in parallel and often elsewhere, the inclusive-OR is more useful than the exclusive-OR. The table above shows 1 for p ∨ q when one or the other or both of p and q is 1.

By NOT we mean that when P is true, NOT-P is false, and when P is false, NOT-P is true. And this relationship the table of p and p' accurately summarizes.

As we see in the tables, we can easily write down formulas of ordinary elementary algebra using plus, minus, times, 1, 0, which will do the same work as Boolean formulas. In fact AND and TIMES are indistinguishable. The algebra formulas $p \vee q = p + q - pq$ and $p' = 1 - p$ are interesting and occasionally useful, but most of the time the operators ∨ (or) and ' (not) of Boolean algebra are more compact and fit more neatly with the expression of circuits.

Interpreting rectifiers

But there are many other types of circuit elements and other mechanisms that have just two states, on and off, closed or open, moved to one side or moved to the other, positioned forward or positioned back. And it is easy, logical, and efficient to represent these two-fold conditions by Boolean algebra also. Each new type of element leads to another interpretation of Boolean algebra.

For example, a fifth interpretation of Boolean algebra is in terms of rectifiers (see Fig. 2). Under the term rectifiers we include vacuum tube diodes, germanium and selenium crystal diodes, etc., any circuit element in which current flows in one direction only.

In Fig. 2, 0 represents "low voltage" and 1 represents "high voltage." In the OR circuit, the output line c will have a high voltage if and only if either a or b or both have a high voltage, because then the potential drop will be all across resistor R. In the AND circuit, the output line c will have a high voltage if and only if both a and b are at a high voltage; for only in that case is there no drop across the resistor.

There is no direct representation of NOT-a using rectifiers; but if the inputs to a rectifier network include all the

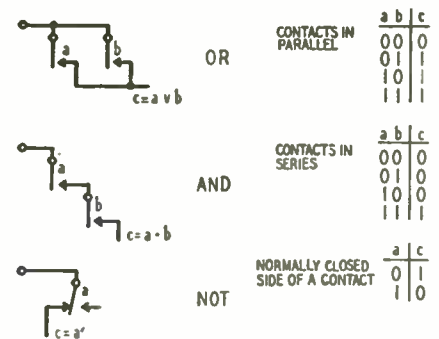

Fig. 1—Basic switch or relay circuit relations expressing Boolean algebra.

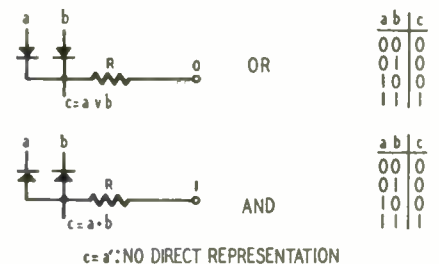

Fig. 2—Boolean relations in rectifiers.

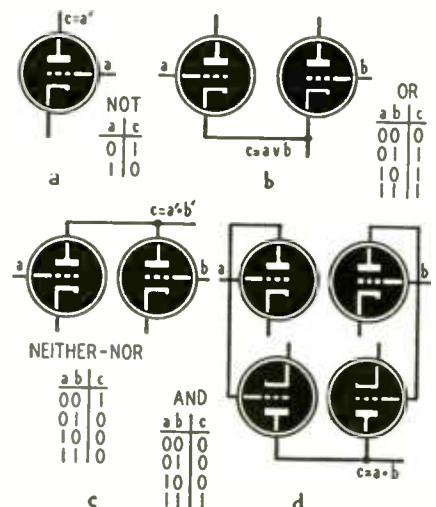

Fig. 3—How triodes fit into the picture.

binary variables needed, a, b, \dots , and their individual negatives, a', b', \dots , then the rectifier network can yield all Boolean functions needed.

A good example of the use of Boolean algebra in a rectifier network to change one set of signals into another set of signals is given in Part 12 of the series "Constructing Electric Brains," by Berkeley and Jensen, appearing in the September, 1951, issue of RADIO-ELECTRONICS, pp. 45-46.

Interpretation of triodes

A sixth interpretation of Boolean algebra is in terms of *triodes* (see Fig. 3). Fig. 3-a is a triode with a signal a on the grid, and a signal c on the plate. If the voltage of the grid is high ($a = 1$), the tube will conduct and the voltage of the plate will be low ($c = 0$). If the voltage of the grid is low ($a = 0$), the tube will not conduct and the voltage of the plate will be high ($c = 1$). The circuit expresses $c = a'$.

In Fig. 3-b, we have two triodes with the cathodes connected. If the voltage on both grids is low ($a = 0, b = 0$), then neither tube will conduct, and the voltage of the cathodes will be low ($c = 0$). In the other three cases, the

voltage of the cathodes will be high ($c = 1$). The circuit expresses $c = a \vee b$.

In Fig. 3-c, we have two triodes with the plates connected. The voltage on the plates will be high ($c = 1$) if and only if the voltage on both grids is low ($a = 0, b = 0$). The table shows the situation. What is the equation for c ?

There is a useful, general rule of Boolean algebra (which we shall call general rule No. 1) that we can use:

1. Suppose we have a complete table of 1's and 0's showing the behavior of some binary variables.
2. Suppose y is the dependent variable and a, b, c, \dots , are the independent variables.
3. Note all the cases where $y = 1$.
4. If any independent variable $a = 0$, write a' ; if any independent variable $b = 1$, write b .
5. For each case, associate a', b, \dots , with AND.
6. For all the cases, associate them with OR.

For example, suppose we have the following table:

Case	a b c	y
1	0 0 0	0
2	0 0 1	1
3	0 1 0	0
4	0 1 1	0
5	1 0 0	0
6	1 0 1	0
7	1 1 0	1
8	1 1 1	0

Now $y = 1$ in two cases: case 2 where $a = 0, b = 0, c = 1$, and case 7 where $a = 1, b = 1, c = 0$. Applying the rule, $y = a' b' c \vee a b c'$

The present instance is Fig. 3-C, and we have:

$$c = a' \cdot b' = (\text{not-}a \text{ and } (\text{not-}b))$$

In ordinary English, c here equals "neither a nor b ."

How do we connect triodes to get a AND b ? In Fig. 3-d, a manner of connection is shown. The outputs of the two upper triodes have to be negated in the two lower triodes (plate-connected) in order to give $c = a \cdot b$. Obviously, therefore, if we are using triodes and want to economize, we should prefer to work with OR and NEITHER-NOR relations, instead of OR and AND relations.

Enough has been said, perhaps, to show that many different kinds of circuit elements may be used to express AND, OR, NOT, EXCEPT, and other relations of Boolean algebra. For example, pentodes could be used to represent relations of Boolean algebra. But how can Boolean algebra simplify circuits?

Let us now take an example of a circuit and its simplification using Boolean algebra.

Suppose we have the circuit shown in Fig. 4-b, which energizes relay Z by means of contacts of relays W, X, and Y shown in 4-a. Our problem is to simplify this circuit.

Looking at 4-b, we see seven (two-way) relay contacts in this circuit, and six wire connections. This makes a total of thirteen *events* that modify information carried in the wires of the circuit. Wherever there is an *event* of this type, the effect on the information is a Boolean algebra operation, as may be seen in the isolated examples shown in Fig. 4-d, 4-e, and 4-f. In either the forking contact of 4-d or the associating contact of 4-e, change in the position of the armature may change the information in the output. In the junction of Fig. 4-f, changing the input from one conductor to the other is the "event" which changes the information in the output.

So we go back to 4-b, and draw blue lines across the circuit, in such a way as to isolate each event, from No. 1 to No. 13. Now we go down through the circuit, calculating the information which is in each wire of the network. Event 1 is the contact w ; hence the right-hand output wire contains w (contact actuated), and the left-hand one w' , or w' (contact not actuated). Event 2 is the contact x . Hence the right-hand output wire contains wx and the left-hand one wx' . Event 3 is a join. Hence the output wire contains $w' \vee wx'$, which reduces to $w' \vee x'$, by Boolean algebra. This modifies the information

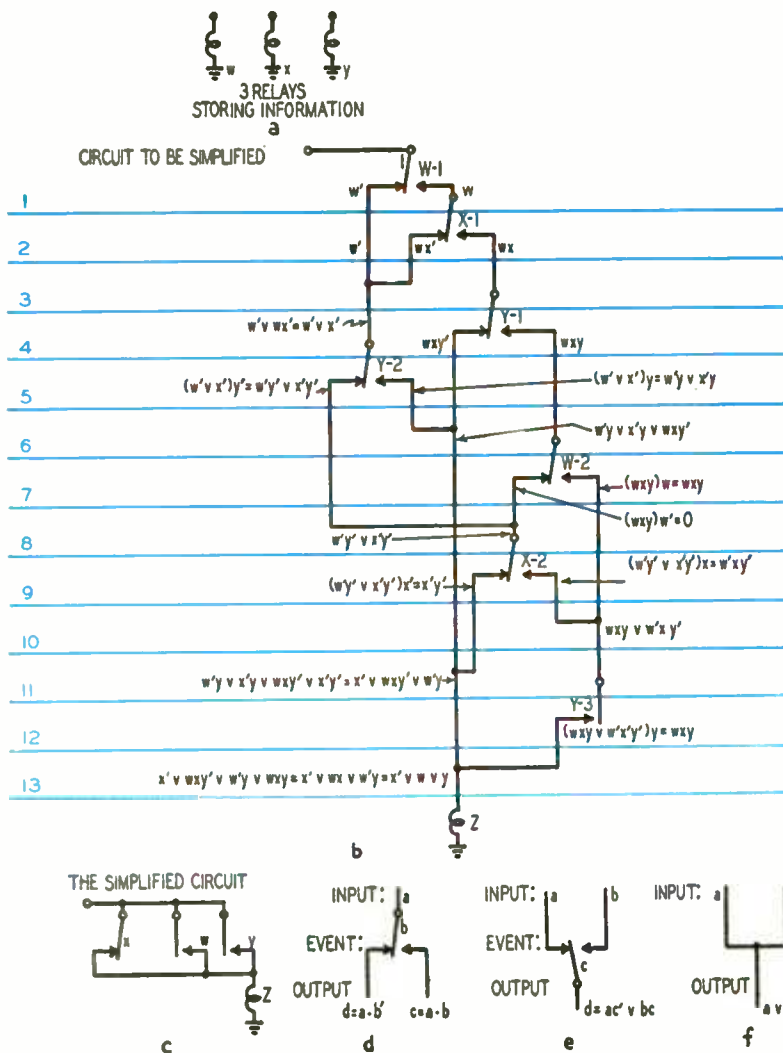

Fig. 4—Example of how circuits can be simplified with the help of Boolean algebra.

in the incoming wires, but in this present type of case, where we want to calculate what information energizes the relay W at the bottom of the diagram, it is not necessary to go back and modify the descriptions of information in the earlier wires. There are, however, circuits where this step is necessary—this is the problem of “back-circuits.”

And so we may go through the whole network, at each event computing the information in each output wire, and finally after event 13 reach the wire which energizes relay Z. The expression for the information in this wire is

$$w y v w x y' v x' v w x y$$

which simplifies into

$$w v x' v y.$$

This expression of course represents a very simple circuit, of three contacts in parallel, and is shown in Fig. 4-c. The circuit of 4-b (provided the contacts have the functions expressed by the labels) reduces to the circuit of 4-c.

The process we have illustrated here is a powerful, general method, and can be applied in many kinds of situations.

Example of circuit design

Boolean algebra may be used in more ways than just simplifying circuits. It may for example be used in the design of circuits, because it can express the “yes-no” elements in the word language describing the problem, just as well as it can express the yes-no elements in the electrical language describing the mechanism.

For an example, let's take the problem of designing the circuits for controlling the steering of Squee.

a. Associating sensations and behavior

We can work through this problem in stages. The first stage is associating the sensations of Squee with Squee's behavior.

The sensations of Squee for steering purposes are those that are derived from the two phototubes, the “right eye” and the “left eye.” In this first stage of the problem, we shall ignore distinctions about kind of light, a.c. or d.c. So, let R equal the truth value of “Squee's right eye sees light,” and let L equal the truth value of “Squee's left eye sees light.”

The behavior of Squee for steering purposes consists of three states: steering clockwise, steering counterclockwise, and no steering at all. Let:

C equal the truth value of “Squee is steering clockwise,”

U equal the truth value of “Squee is steering counterclockwise,” and

N equal the truth value of “Squee is not steering.”

Squee must choose between these three kinds of behavior depending on Squee's sensations. How do we associate behavior with sensations? In Fig. 5 we see the various cases displayed; and we can see what we want to arrange. This is summarized in the following table:

Case	R	L	C	U	N
1	0	0	1	0	0
2	0	1	0	1	0
3	1	0	1	0	0
4	1	1	0	0	1

Using our general rule No. 1, we have:

$$C = R'L' \vee RL'$$

$$U = R'L,$$

$$N = RL.$$

Translating these equations into words: Squee should steer clockwise when the left eye does not see light; Squee should steer counterclockwise when the left eye sees light but the right eye does not see light; and Squee should not steer at all when both eyes see light.

Suppose that we had relays corresponding to C steering clockwise, U steering counterclockwise, and N no steering, the schematic for the behavior of Squee would be as in Fig. 6.

b. Associating behavior and action

But Squee does not have “acting organs” corresponding directly to the three states of behavior. Instead, Squee has a steering motor, whose normal direction is such that Squee steers clockwise, and a relay, by means of which the motor may be run in either direction. See Fig. 7. So, let X equal the truth value of “The motor is running” and let W equal the truth value of “The reversing relay is energized.”

How do we associate actions X and W with behavior C, U, N? The logical association is shown in the following table:

R	L	C	U	N	X	W
0	0	1	0	0	1	0
0	1	0	1	0	1	1
1	0	1	0	0	1	0
1	1	0	0	1	0	0 or 1

which expresses the conditions:

(1) The motor is running if and only if C or U;

(2) The motor is reversed if U, and may or may not be reversed if N.

From this table and general rule No. 1, we obtain:

$$X = C \vee U = L \vee R'L = R' \vee L'$$

W = either U, or $U \vee N =$ either R'L, or $R'L \vee RL$, which latter reduces to L. Since we may use either one of the two expressions for W, we can of course use the simpler one, $W = L$. The schematic circuit that corresponds to these equations is shown in Fig. 8.

c. Taking into account a.c. or d.c. light, and homing on the nest or seeking nuts

We have proceeded thus far ignoring the distinction between a.c. and d.c. light, and whether Squee should be homing on the nest, or seeking nuts. But at this stage, we need to take the distinction into account, and we need to translate the previously assumed R and L sensations into appropriate sensations of a.c. and d.c. light depending on Squee's program.

The information reported by the amplifying circuits attached to the photocells is shown schematically in Fig. 9.

Four relays labeled Ra, Rb, La, Lb, are energized in the plate circuits running from the amplifier tubes. The labels are also used for truth values:

Ra: the truth value of “The right photocell sees a.c. light”;

Rb: the truth value of “The right photocell sees any light”;

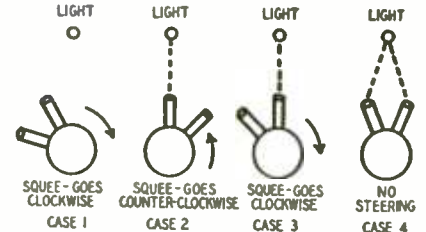

Fig. 5—The sensation circuits of Squee.

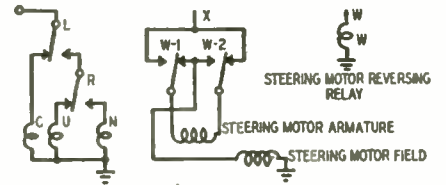
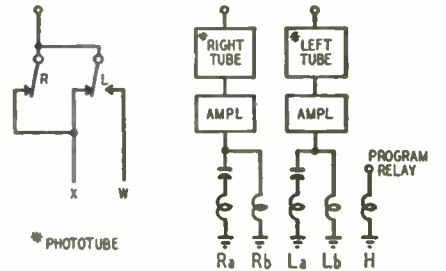

Fig. 6, left—Hypothetical steering circuit. Fig. 7, right—Motor circuitry.



Figs. 8 and 9—Diagrams of light scanning and motor control circuits in Squee.

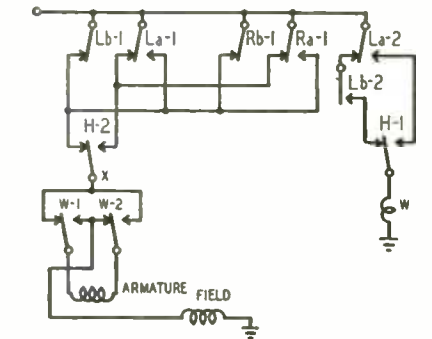

Fig. 10—Steering motor control circuit.

La: the truth value of “The left photocell sees a.c. light”;

Lb: the truth value of “The left photocell sees any light.”

Looking at Fig. 9, we can see that the amplifying circuit does not report directly “the photocell sees d.c. light.” This information must be obtained indirectly.

The H relay shown is the “program” relay which remembers whether Squee is homing on the nest or seeking nuts. If the relay is energized, Squee should pay attention only to a.c. light. If the relay is not energized, Squee should pay attention only to d.c. light. Whether or not it is energized depends on other sensations of Squee (the “tongue” switch, etc.). The letter H, taken from the first letter of “homing,” is used to label the relay and also to stand for the truth value of “Squee is homing on the nest”.

Now, how do we convert the assumed

sensations R and L that we used earlier, into the actual sensations Ra, Rb, La, Lb, with due regard to the program H? We can make two tables and fill in the cases according to our understanding of what is to happen:

Case	Ra	Rb	H	R
1	0	0	0	0
2	0	1	0	1
3	1	1	0	0
4	0	0	1	0
5	0	1	1	0
6	1	1	1	1

Case	La	Lb	H	L
1	0	0	0	0
2	0	1	0	1
3	1	1	0	0
4	0	0	1	0
5	0	1	1	0
6	1	1	1	1

We can see from Fig. 9 that the case Ra equals 1 and Rb equals 0 is impossible, and so it does not have to be listed. Using general Rule 1 to summarize the table we have:

$$R = Ra' \cdot Rb \cdot H' \vee Ra \cdot Rb \cdot H$$

$$L = La' \cdot Lb \cdot H' \vee La \cdot Lb \cdot H$$

Since Ra · Rb' is impossible, Ra is the same as Ra · Rb. Therefore,

$$R = Ra' \cdot Rb \cdot H' \vee Ra \cdot H$$

$$L = La' \cdot Lb \cdot H' \vee La \cdot H$$

Now,

$$X = R' \vee L'$$

$$= (Ra' \cdot Rb \cdot H' \vee Ra \cdot H)' \vee (La' \cdot Lb \cdot H' \vee La \cdot H)'$$

Using the Boolean algebra rule:

$$(mk \vee nk')' = m'k' \vee n'k,$$

we have:

$$X = (Ra' \cdot Rb)' \cdot H' \vee Ra' \cdot H$$

$$\vee (La' \cdot Lb)' \cdot H'$$

$$\vee La' \cdot H$$

$$= (Ra \vee Rb)' \cdot H' \vee Ra' \cdot H$$

$$\vee (La \vee Lb)' \cdot H' \vee La' \cdot H$$

$$= (Ra \vee Rb' \vee La \vee Lb') \cdot H'$$

$$\vee (Ra' \vee La') \cdot H$$

Also,

$$W = L$$

$$= La' \cdot Lb \cdot H' \vee La \cdot H$$

We now have precisely the Boolean expressions that we want, to write down a circuit for controlling the steering of Squee. We obtain X by using four R and L contacts in parallel, running to the negative side of an H contact, and two more R and L contacts in parallel running to the positive side of the same H contact. Similarly we obtain W. See Fig. 10.

This brings us to the end of our short introduction to Boolean algebra, and its use in the design and simplification of circuits involving "yes" and "no" elements. We shall be glad to hear from any reader who is interested in Boolean algebra or in the design and construction of small robots or computers.

—end—

BRAIN SENDS MORSE CODE

The *Codetyper*, a 40-tube brain which sends perfect Morse code as the operator types the message on standard typewriter keys, has been announced by N. Dorfman, New York inventor and electronic technician.

Electronic FLAME CONTROL

By THOMAS L. BARTHOLOMEW

Knowledge of flame controls is needed for their maintenance. Here is how they work.

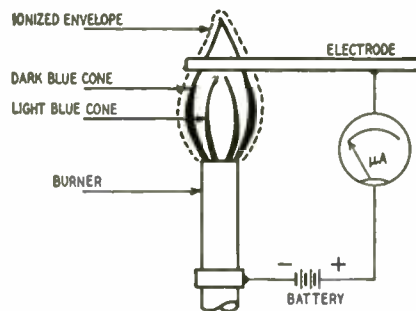

Fig. 1—Diagram of a flame rectifier.

FOR the service man interested in adding maintenance of new electronic devices to his work, here is a device that is right in line with his regular job. With the exception of one new theory, this type of circuit is generally known to most radiomen.

Electronic flame-control devices are found where automatic gas- or oil-fired equipment is used. Their function is to prevent the continued flow of unignited fuel into the combustion space during a flame or ignition failure. An additional important safety function is the prevention of any attempt to relight the burner until a predetermined time has elapsed. This time period allows the fumes to escape and the combustion chamber to be refilled with fresh air—thus preventing an explosion.

The flame is controlled by a flame rod or phototube connected to a twin-

triode. The tube in turn operates a relay which—along with a timing arrangement—is the basis of the whole operation.

The rectifying action of a flame electrode depends first of all upon the fact that the chemical action of combustion results in ionizing some of the molecules of gas. The presence of these electrically charged particles enables the flame to conduct a current between two electrodes in contact with it, as indicated in Fig. 1. A steady d.c. voltage is applied across the flame electrode and grounded burner, and a corresponding direct current flows through the flame. Fig. 1 is a schematic diagram intended to suggest, in a very simple way, the way that current flows through the flame. In Fig. 2-a are shown two electrodes of equal size. If electrode X is at a positive potential, and electrode Y negative, the negative ions (free electrons) will be attracted to X and positive ions (molecules positively charged by the loss of electrons) to Y. Electrons reaching X will be absorbed, to replace some of those that have surged through the external circuit to create the negative charge on electrode Y. Positive ions that reach Y will absorb electrons from it and thus become electrically neutral.

With the combustion process continuing, and with a continuous flow of freshly ionized gases through the space between the electrodes, it is apparent that the flow of current in the circuit can also be continuous while an electric



Front view of the Wheelco Flame-otrol.

voltage exists between the two electrodes. In the system represented in Fig. 2-a it does not matter which electrode is positive or which is negative; the process will work either way. Thus if an alternating voltage is applied as indicated, the resulting alternating current in the external circuit will be the same in both halves of the cycle.

The second fact on which rectification by a flame electrode depends is that current will flow more readily in one direction than the other, if one electrode surface is larger than the other. A simple but essentially accurate explanation is suggested in Fig. 2-b, where electrode X is shown as approximately one-fourth the size of Y. Remember:

1. Positive ions are much larger and heavier than free electrons, and
2. Each electrode is at or near peak voltage during only half, or less than half, of each cycle (1/150 second, perhaps, with 60-cycle current).

In the small fraction of a second during which each ion is subjected to a definite electrostatic attraction from the oppositely-charged electrode, the light electron can move considerably farther than the heavy positive ion. With a large difference in electrode areas, the number of heavy positive ions "within traveling distance" of the larger electrode will be greater than the number of electrons within traveling distance of the smaller one. Thus, when X is positive, a large number of

electrons will reach it, and a correspondingly large (not necessarily equal) number of positive ions will be drawn to Y. But in the other half-cycle, although a great many electrons may reach the large electrode Y, the number of positive ions reaching X will be relatively small. The effective current in the external circuit is directly dependent on the number of electrons "withdrawn from circulation" by reunion with positive ions (that is, poured into the flame at the negative electrode). Consequently, the flow of current in one direction in the external circuit is substantially greater than that in the other. The difference is measurable as a direct current; a d.c. microammeter will register only the net surplus of current in the one direction. Likewise, a voltage meter would register a small d.c. voltage, as if the burner Y and flame electrode X together made up a voltaic battery with X the negative pole.

The electrical reaction is the same for the phototube and flame rod. Thus in practical installations the two can be interchanged without any change in the electrical circuit. Sometimes the

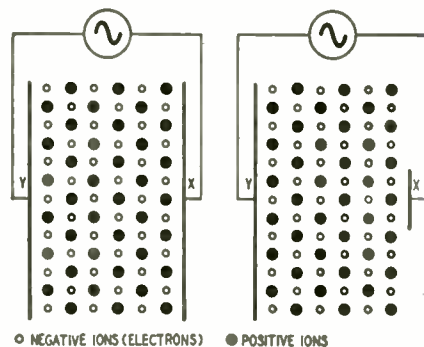

Fig. 2-a (left)—Currents in the circuit are equal for both half-cycles. Fig. 2-b (right)—Currents are unequal in this circuit where electrodes vary in size.

flame rod and phototube are connected in parallel to control one flame.

Throughout the country there are six or eight manufacturers of electronic flame-control devices. All use the same basic principles of operation. The two most popular are Wheelco Instruments Company's *Flame-otrol* and the Brown Instruments *Protectoglo*.

Fig. 3 shows the electrical layout of the Flame-otrol up to the point of the first relay. The flame rod or phototube is brought to the circuit by a shielded single-conductor cable and connected at points marked ELECTRODE and SHIELD.

The tube used in the Flame-otrol is comparable to the 53. However the

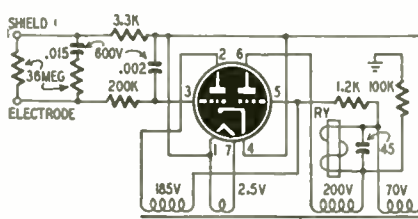

Fig. 3—Basic circuit of the Flame-otrol.

Flame-otrol tube is held to such close tolerances in manufacture and inspection that if we were to attempt to replace it with a 53 we would find only about one out of six of the 53's which would work.

In the Protectoglo circuit of Fig. 4, a 12SN7 is the controlling tube. This is a recent change made within the last year. The models previous to this used two 7N7's with a slightly changed circuit. Still older models used two 6V6's. Here again we encounter the problem of selecting tubes with very close tolerances to operate the delicate circuit. The manufacturer has set very rigid requirements and the percentage of rejected tubes at inspection is high. Therefore, not all stock radio tubes can be expected to give satisfactory results.

The electrical circuit of the Protectoglo is very simple, yet highly efficient. The triode section operating the relay would normally operate with a positive grid and relay energized. However, with the first triode connected to the grid of the second triode as shown, the grid of the second triode will become negative whenever the first triode is conducting (flame out). With the flame lit, a negative voltage is created on No. 1 grid. This blocks the current to the No. 1 plate, allowing No. 2 grid to go positive and current to flow in the second triode.

Maintenance of these instruments is very similar to any circuit where a tube, transformer, and a couple of relays are involved. The tubes, if replaced when recommended, are rarely a source of trouble. Probably the most common fault is the insulator of the flame rod, or the lens of the phototube (which becomes covered with soot or smoke). Of course the cure is to remove the tube or rod or wipe off the soot. If the soot problem becomes too annoying, a pipe plug is provided on the side of the phototube and flame rod housing for the purpose of piping in a small blast of dry air to drive the soot away.

Another common fault is that the flame sometimes is blown away from the burner by a strong draft, thus breaking the circuit to the flame rod. This can be overcome by welding a rod to the burner that will extend out into the flame. A more practical solution to the problem is to install a pilot burner manufactured by either Wheelco or Brown. These pilot burners are especially designed to overcome this difficulty. Where spark ignition is used, always keep the spark plug as far away from the flame rod as possible.

—end—

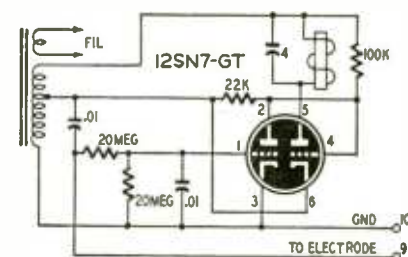
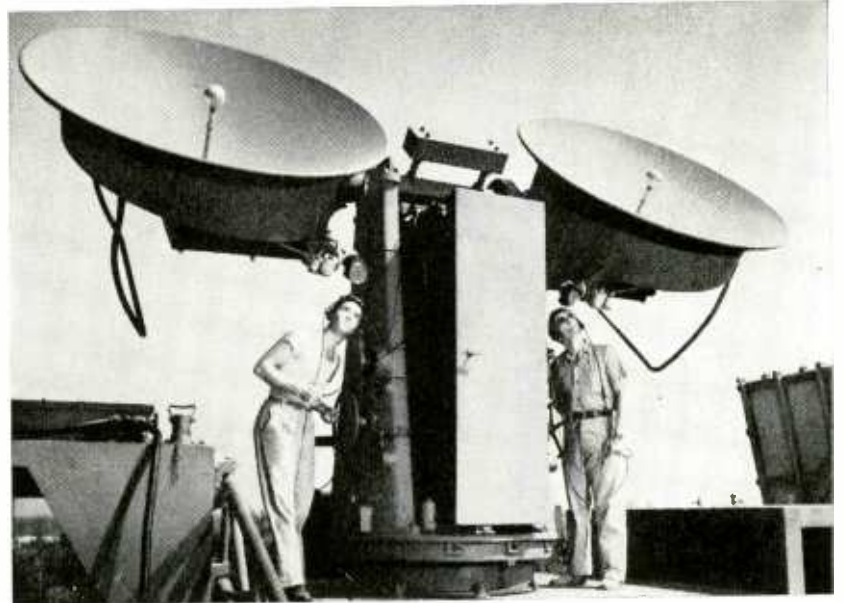

Fig. 4—Protectoglo uses 922 phototube.

RADIO and RADAR AID AIR RESEARCH



Doppler velocity radar tracks the rocket-powered models and records their speed.

FIVE years from now our skies will be filled with new types of aircraft. They will streak across the skies faster than sound, making today's jets seem slow by comparison. Data needed for designing these very-high-speed aircraft is already being compiled with the help of radio and radar on an isolated sand island off the Virginia coast.

The Wallops Island station was established by the National Advisory Committee for Aeronautics (NACA) in 1945, at a time when information on transonic flow conditions was virtually non-existent and could not be obtained in wind tunnels. The information was needed by men who were designing supersonic research airplanes, jet fighters, and guided missiles. Since then, more than 1,500 research models have been fired at Wallops.

A rocket propels the test vehicle to the desired supersonic speed. Radar determines the location of the model in space and its velocity at any time during the flight. A special type of radio telemetering system obtains a record of the aerodynamic reactions of the model as measured by instruments carried inside it.

The rocket vehicles are launched from stands on the beach. They quickly attain high speeds, passing through the transonic range and into the supersonic within a few seconds. The data sought by NACA are obtained during the entire flight of the model, and especially while it is flying at transonic and supersonic speeds. Some useful information is picked up while the model is accelerating above 600 m.p.h. and considerably more while the model is decelerating through the transonic range, after the rocket power has been exhausted.

The rocket-propelled research models soar to great heights and travel five to ten miles before plunging into the sea several miles off shore. Most attain an altitude of 15,000 to 30,000 feet; some fly as high as 100,000 feet. Top speeds range from 15 to 40 miles per

minute; most of the models attain a speed of 20 miles per minute (1,200 m.p.h.). Usually the entire flight is completed in less than two minutes—sometimes in only 30 or 40 seconds.

During the first half or third of that period, all the data required from a given model are obtained by an array of electronic devices, radio apparatus, and automatic recorders. Pressure-measuring devices, a radio telemeter transmitter, and other miniature instruments are carried aloft in the model. Radio receiving sets, recording apparatus, and a control panel for firing the rocket are housed in a concrete building at the launching site. Our cover shows two of the antennas used for tracking the model and receiving information from it.

Most of the records are made photographically on fast-moving strip film, so that all results of the test are recorded graphically on the same film, and can be compared in relation to time and distance. Data obtained at any point in the flight can be seen clearly in relation to all other test conditions. Even the distance the rocket has traveled from the launching stand can be calculated within a few feet, at any point in the film.

During its flight, the model can be put through a series of programmed maneuvers simulating a wide range of flight conditions. It can roll, climb, dive, and turn like an airplane, exerting varying forces on the wing and tail surfaces. These maneuvers are initiated by setting an automatic control mechanism for the desired program before take-off.

The recorded reactions of the model to these maneuvers are used to determine the maneuverability, stability, and control characteristics of the airplane which the scale model represents. Measurements of lift and drag also are obtained in this test.

Although it soon flies out of sight, the model is tracked by radar and the desired information is radioed from the

model over ten telemeter channels. The telemeter unit, powered by tiny batteries, is turned on just before the rocket is fired. Motion pictures are made of all launchings, but the most valuable technical information is that telemetered back to earth from the model itself in full flight.

The telemeter transmits readings given by numerous pressure pick-ups and other instruments. These include a running record of acceleration, position of the controls, forces on the controls, aerodynamic forces (such as lift and drag) acting on the model, pressures acting on the surface of the model, attitude of the model in respect to the air stream, and sometimes temperature.

A Doppler velocity radar and a flight path radar are used. Radar tracking provides comparative data that can be matched with the data telemetered. In the brief span of a minute or so, all the information needed for research purposes is recorded automatically on drums of graph paper or photographic film, to be analyzed later by scientists and computers.

Usually the model does not resemble any specific airplane, but occasionally it is a dynamic scale model of some extremely fast plane or missile that is still in the design stage.

It has not been found practical to attempt to recover the models. From the start, every effort has been made to obtain as much useful data as possible from a single flight. The techniques which have been devised permit obtaining complete measurements of lift, drag, stability, and control over the complete speed range from a single model. Sometimes several variations of a model are flown in order to obtain more data.

All the test data needed from one model for a certain phase of research can be obtained in those few seconds. Seldom is it necessary to fire more than one model of a specific design. The model is expendable and falls into the ocean.

—end—



NOW-Be a Fully Trained, Qualified RADIO TELEVISION TECHNICIAN IN JUST 10 MONTHS OR! LESS!

**I Send You
18 BIG
KITS
OF RADIO-
TELEVISION
EQUIPMENT**

**New "Package" Unit Training Plan
PAY AS YOU LEARN-YOU SET THE PACE!**

**No Monthly Payment Contract
to Sign!**

Now . . . be ready for Radio-Television's big pay opportunities in a few short MONTHS! Frank L. Sprayberry's completely new "Package" training unit plan prepares you in just 10 MONTHS . . . or even less! Equally important, there is NO monthly payment contract to sign . . . thus NO RISK to you! This is America's finest, most complete, practical training—gets you ready to handle any practical job in the booming Radio-Television industry. In just 10 months you may start your own profitable Radio-Television shop . . . or accept a good paying job in this fascinating expanding field at work you've always wanted to do. Mr. Sprayberry has trained hundreds of successful Radio-Television technicians—and stands ready to train you in less than one year, even if you have no previous experience. You learn by DOING . . . actually working with your hands with equipment of special design to illustrate basic theory instead of relying on books alone.

VALUABLE EQUIPMENT INCLUDED WITH TRAINING

The new Sprayberry "package" plan includes many big kits of genuine, professional Radio-Television equipment. While training you actually perform over 300 demonstrations, experiments and construction projects. In addition, you build a powerful 6-tube standard and short wave radio set, a multi-range test meter, a signal generator, signal tracer, many other projects. All equipment is yours to keep . . . you have practically everything you need to set up your own service shop. The interesting Sprayberry book-bound lessons and other training materials . . . all are yours to keep

EARN EXTRA MONEY WHILE YOU LEARN!

All your 10 months of training is AT YOUR HOME in spare hours. Keep on with your present job and income while learning . . . and earn EXTRA CASH in addition. With each training "package" unit, you receive extra plans and ideas for spare time Radio-Television jobs. Many students pay for their entire training this way. You get priceless practical experience and earn generous service fees from grateful customers. Just one more reason why the Sprayberry new 10 MONTH-OR-LESS training plan is the best Radio-Television training in America today. If you expect to be in the armed forces later, there is no better preparation than good Radio-Television training.

FREE 3 BIG RADIO-TELEVISION BOOKS

I want you to have ALL the facts about my new 10-MONTH Radio-Television Training—without cost! Act now! Rush the coupon for my three big Radio-Television books: "How to Make Money in Radio-Television," PLUS my new illustrated Television Bulletin PLUS an actual sample Sprayberry Lesson—all FREE with my compliments. No obligation and no salesman will call on you. Send the coupon in an envelope or paste on back of post card. I will rush all three books at once!

TRAIN AT HOME IN SPARE HOURS!

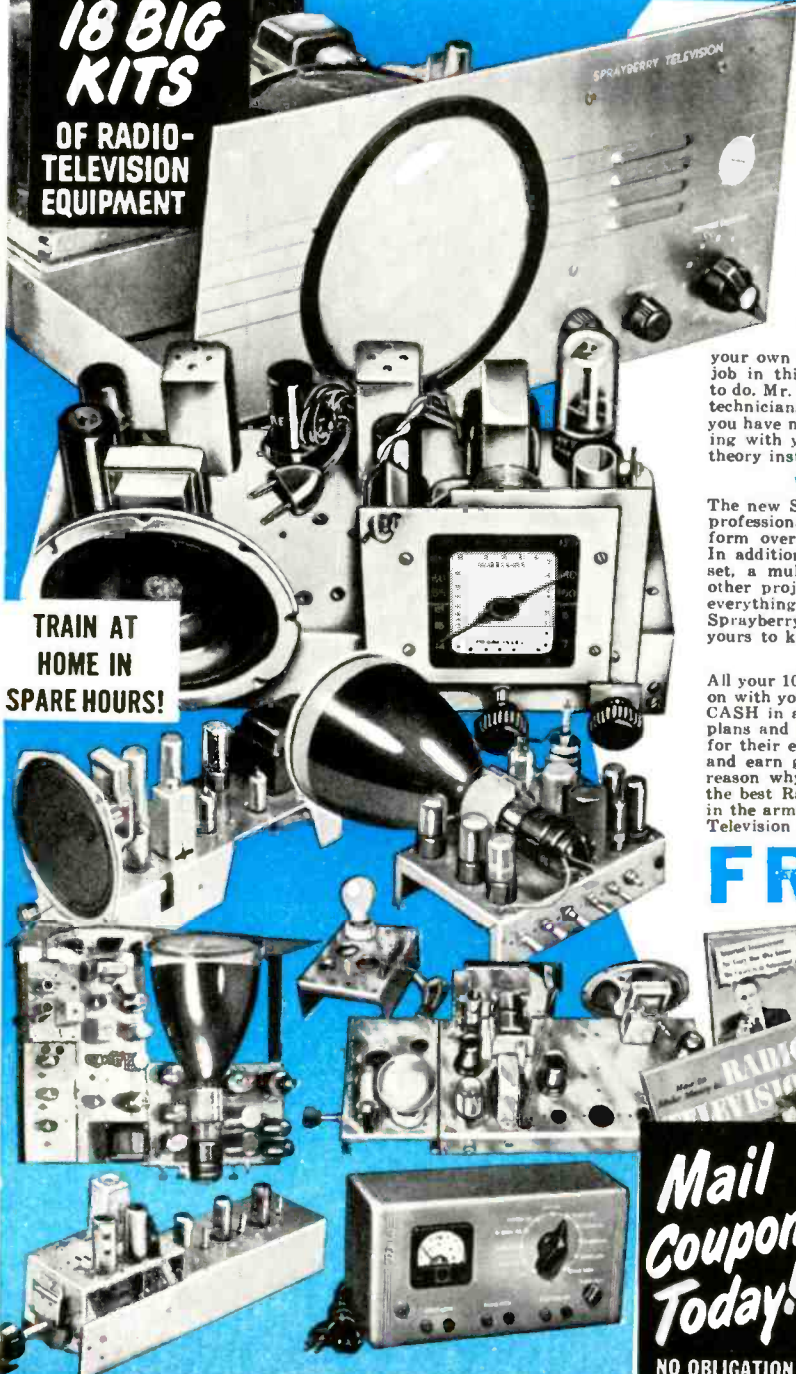

IF YOU ARE EXPERIENCED IN RADIO

Men already in Radio who seek a short intensive 100% TELEVISION Training with FULL EQUIPMENT INCLUDED are invited to check and mail the coupon at the right.

Mail Coupon Today!
NO OBLIGATION
No Salesman Will Call

SPRAYBERRY ACADEMY OF RADIO, Dept. 20F
111 North Canal St., Chicago 6, Ill.

Please rush to me all information on your 10-MONTH Radio-Television Training Plan. I understand this does not obligate me and that no salesman will call upon me.

Name..... Age.....

Address.....

City..... Zone..... State.....

Please check Below About Your Experience

Are You Experienced? No Experience

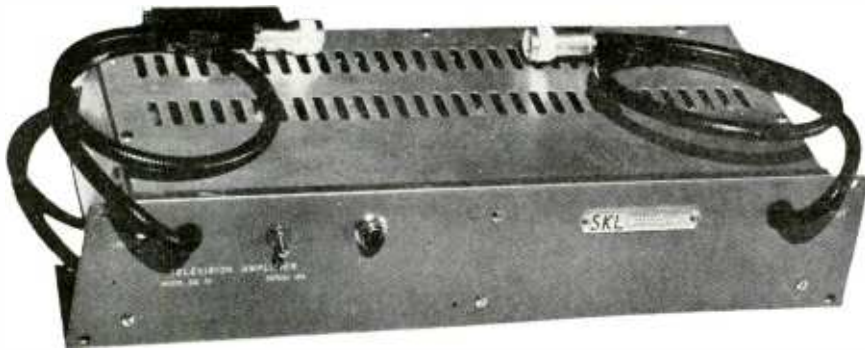

The wide-band amplifier above provides a 21 decibel gain flat from 40 to 225 mc.

Amplification of a wave along a wave delay line makes possible the boosting of signals over an extended frequency range.

Wide-Band Chain Amplifier By ROBERT L. GISH

DURING the 1951 IRE Convention in New York City, many people learned of a new type of wide-band television amplifier. This device, which incorporates the new principle of chain amplification, is so unusual in its design and so unconventional in its method of operation as to be of wide interest.

This amplifier is being produced, in this country, by the Spencer-Kennedy Laboratories, Inc., of Cambridge, Mass. Although the model currently available (and described in their Bulletin 212-3) is designed specifically for television use, the principle appears to be applicable to many other wide-band amplifier problems.

The accompanying simplified schematic diagram (Fig. 1) shows the arrangement of circuit components. There are no r.f. circuits to switch or tune, since the entire TV band is amplified simultaneously. This design avoids loss of picture resolution due to frequency drift or inadequate bandwidth. The device is said by the manufacturer to have a nominal gain of 21 db, a flat response characteristic (± 1.5 db) from 40 mc to 225 mc, and a very low noise figure.

Theory of operation

The amplifier consists of two stages, each incorporating six 6AK5 tubes with grids connected at equal time intervals along an artificial delay line, and plates

connected at corresponding time intervals along another delay line. The lines consist of a series of lumped inductances and the input and output capacitances of the tubes.

R.f. entering the input travels along the grid delay line, exciting each grid in turn, until it is finally absorbed by the line-terminating resistor (R1). When the r.f. signal voltage reaches the grid of V1, a corresponding voltage wave produced at the plate begins to travel down the plate delay line toward the output. This amplified wave reaches the plate of each succeeding tube at the same time the amplified signal through that tube appears on its plate; thus the wave traveling along the plate delay line increases in amplitude until it reaches the output of the first stage, where it is coupled to the external load (the grid delay line of the second stage) through capacitor C2. Those components of the wave which travel backward along the plate delay line are of no value (since they are predominantly out of phase), but cause no ill effects, and are absorbed by the plate delay line terminating resistor (R2).

The second stage operates exactly like the first, except that its output is coupled, through capacitor C3, to a matched external load.

The limits of the frequency band which can be amplified by this type of amplifier are largely determined by the value of the coupling capacitors in the

circuit, and by the characteristics of the delay line. The low-frequency response is limited by the impedance of the coupling capacitors; the high-frequency response is limited by the low-pass filters formed by the series inductance and effective shunt capacitance of the delay lines.

Advantages and uses

Since each tube in the amplifier provides a gain of about 1.6 db, independently of all other tubes, the failure of a single tube does not result in amplifier failure or distorted output, but simply a slight loss of amplification. The amplifier may operate for long periods of time without attention. The amplifier is housed in a case well suited for installation in rack type equipment. As a remote booster for commercial TV demonstration, it would not need individual channel tuning or adjustment. As a pre-amplifier for TV field strength meters or other applications, it would provide uniform gain over a wide range. Transformers are available to match the input and output to a variety of commonly used circuits.

According to the manufacturer, this device may be used to drive a number of TV receivers from a single antenna, to feed long transmission lines for systems in valleys or in the shadows of mountains, or to feed a single TV set in a fringe area.

—end—

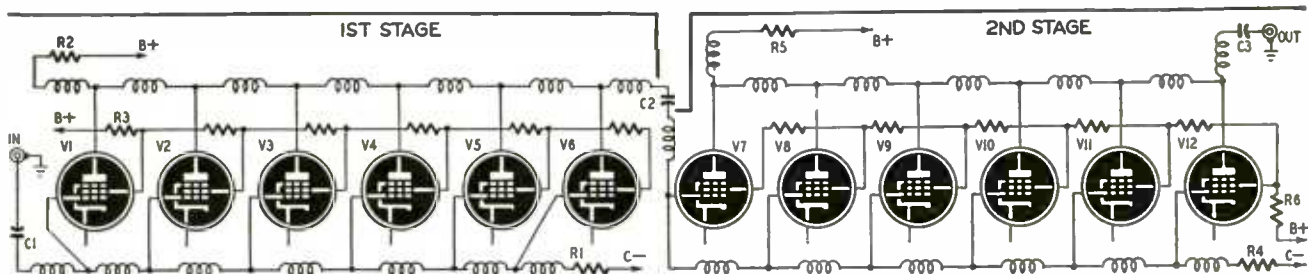

Schematic of the TV booster which uses 12 tubes in cascade, 6 per stage. Note that screen bypass capacitors are not needed.

This TV team is what you need



for sure television capacitor replacements

When you replace television capacitors you want to *know* that your replacements won't cause "headaches" in unnecessary call-backs because of premature failure. You *can* be sure that these Sangamo TV replacements will live up to their reputation. Used as original equipment, they're "tops" for dependable replacements.



THE REDSKIN is a molded paper tubular, especially adapted to television. It's easy to work with—the leads are securely imbedded in a hard plastic case and have been especially designed to resist breakage. The REDSKIN is strong and it's dependable at 85° C, even under extreme humidity.

THE CHIEFTAIN is a dry electrolytic that fits anywhere! Tiny, but durable, it is ideal for application in tight spots beneath a chassis. Bare tinned-copper wire leads make it easy to mount. Maintains uniform capacity when subjected to high ripple currents at 85° C.

REMEMBER . . . these are only two of a complete line of mica, paper and electrolytic capacitors that will take care of practically any replacement requirement in the radio and television field.



Your Assurance of



Dependable Performance

SANGAMO ELECTRIC COMPANY

MARION, ILLINOIS

IN CANADA: SANGAMO COMPANY LIMITED, LEASIDE, ONTARIO

2 new exclusive imp

GET THEM NOW
ON THE **N**ational
TELEVISION

1 A MAGNETICALLY FOCUSED TUBE
WHICH ELIMINATES A COSTLY
FOCUSING COIL

2 A BETTER GLARE-PROOF FACE
WHICH ELIMINATES PRACTICALLY
ALL DISTURBING REFLECTED LIGHTS

A clearer better picture tube than
any other made...for conversion
and replacement in every standard set.

Write for name of Representative nearest you
3019 West 47th Street, Chicago, Ill.

Three plants with over 17 acres of co-
ordinated machinery and personnel,
producing the world's finest tele-
vision picture and receiving tubes.



National Video Corporation

3019 W. 47th St.
Chicago

Grays Lake
Illinois

901 W. Huron St.
Chicago

Important advancements

V *ideo* C *orp.*

BOTH ADVANCEMENTS YOURS —
BECAUSE OF N.V.C.'S INDEPENDENT
UNHAMPERED AND FORWARD
THINKING ENGINEERING.

N PICTURE TUBES

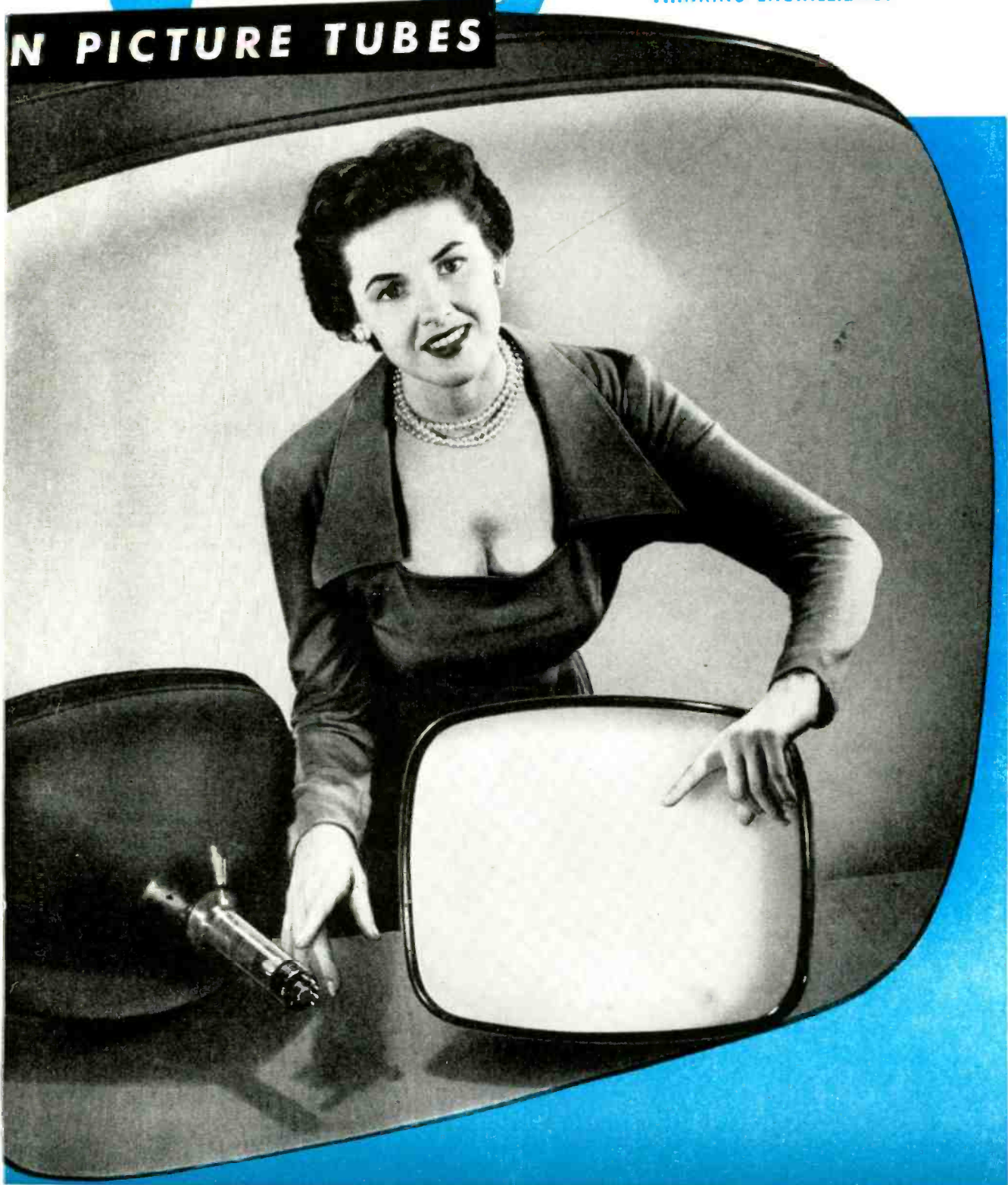

Beginners V. F. Oscillator

The author discusses oscillator characteristics which cause instability and shows how these may be overcome

By GILBERT L. COUNTRYMAN

DO those v.f.o.'s you read about appear too complicated? Don't be discouraged. This article will show how you can design your own v.f.o. to add to your present rig, and build it from scratch without denting your pocketbook. Practically everything needed may be found among surplus parts.

There is nothing mysterious or complicated about variable-frequency oscillator control. Any vacuum-tube oscillator circuit may be adapted for v.f.o. operation. This includes the Hartley, Colpitts, e.c.o., t.p.t.g., dynatron, etc. Some have inherent frequency stability while others do not. A few are easy to key, and some can be made to operate effectively only with careful tailoring or by the use of exact component values.

One important point should be borne in mind from the start: no v.f.o. should go on the air that is not equal to crystal control in frequency stability, keying, tone, and absence of drift. This standard of performance is not difficult to attain with a good v.f.o.

Before discussing the factors contributing to good v.f.o. design let us first consider the various methods used for changing the frequency. It is possible to use any method of continuously varying either the inductance or the capacitance to obtain a desired change in frequency. The inductance may be varied by changing the position of an iron core within the coil or with a variometer in which the angular position between two series-connected coils is varied. Both methods require careful tailoring, which is generally possible only at the factory or laboratory. A variable capacitor, in series with the coil, across all of the coil windings or across only a portion of them, is both a simple and convenient method.

Frequency drift

Let's see what makes an oscillator drift in frequency. There are two factors—both having to do with changes in temperature. First of all, materials expand or contract with changes in temperature. Unfortunately these materials may be wire, coil forms, capacitor plates, or any of the elements that go to make up your frequency determining circuit. Taking an absurd example, let us assume that a component 10 inches long expands 10% when heat is applied.

We will assume that the one inch increase in length causes a 2-kilocycle change in frequency. The first remedy would be to cut down the physical size—which can readily be done at the lower frequencies used by amateurs. Let's cut it down to one inch—now the expansion is only 1/10 of an inch and the resultant drift is only 200 cycles instead of 2,000 cycles. The reduced drift can be canceled out by effectively using the property of certain materials which shrink rather than expand when heated.

The other change due to temperature rise is in the tube itself. The elements of a tube represent the plates of small

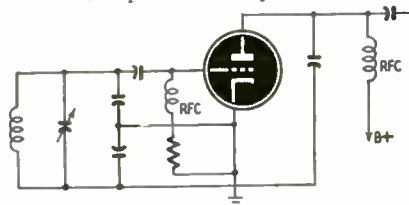

Fig. 1—The Colpitts oscillator circuit.

capacitors and some of these capacitances are across the v.f.o. frequency determining coil-capacitor circuit and affect the frequency. What happens when filament and plate voltages are applied to the tube? With the resultant heat these elements change in size and position, and there is a gradual change in capacitance until the maximum temperature has been attained, say, after 60 minutes.

Again, to use an absurd example: let's say a coil has a 100- μ f capacitor across it, and the tube capacitance across it is also 100 μ f. When the tube heats up, the tube capacitance reduces to 50 μ f, making the new total capacitance 150 μ f—resulting in a big change in frequency.

If we redesign the tank circuit, changing the coil until it requires 2,000 μ f of capacitance to resonate at the desired frequency, the tube capacitance will still change 50 μ f when heated, but the change is now only 2½% of the total instead of 25%.

Summarizing our findings:

1. Use the smallest components possible. This means a coil ¼ inch in diameter instead of 3 inches. Use physically small capacitors and resistors, and miniature tubes.
2. Use a circuit requiring lots of fixed capacitance across the tube grid

and cathode so that changes in the tube capacitance will not materially affect the frequency.

3. Use zero temperature coefficient fixed capacitors, or silver micas paralleled with small negative temperature coefficient types.

(Reducing the size of the coil form does not apply to high-C oscillators like the Clapp and Colpitts. Such circuits require high-Q inductors for efficient operation over their tuning range. This requirement is met by using large diameter wire and a form having a diameter approximately equal to the winding length. Such a coil is used in the v.f.o. shown in Fig. 3.—Editor)

Oscillator stability

The common term for piezoelectric crystals is "rocks," not only because they are made of rock (quartz) but probably also because their notes are as steady as a rock.

The variable-frequency oscillator note can also be as steady as a rock, but only if it is constructed so that its mechanical rigidity is rock-like. The only parts in an oscillator that should move in the slightest degree are the rotor plates in the variable capacitor—without any axial displacement. The wire must be so tight on the coil form that it cannot be moved with the fingernails. All parts must be fastened down with heavy machine screws and lock washers; strain-free, solid bus wire connections should be used, and a variable capacitor with double bearings is necessary. After a joint is soldered, touch the iron to it again. This lets the wires "relax" and shift to a less strained position before the solder hardens again.

All leads from the v.f.o. should be cabled with lacing cord so that the wires cannot shift position. Don't forget to use cable clamps to lash down the cable to the chassis. Leads which move alter the capacitance to other parts and ground.

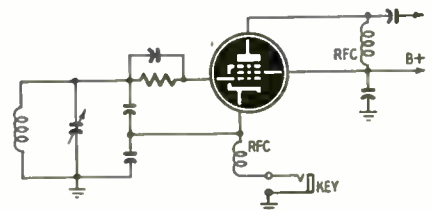
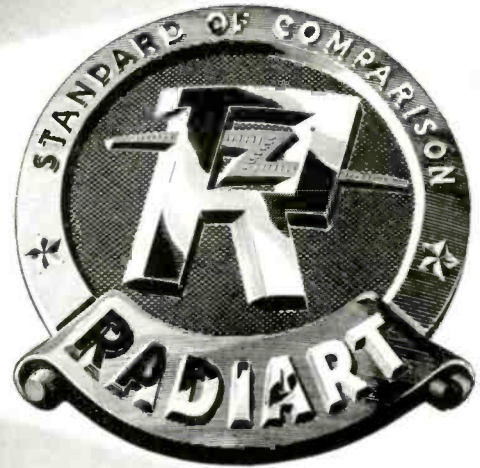

Fig. 2—Modifications in the oscillator.

A Guiding Beacon For Quality Electronic Parts



Your Local
RADIART
Distributor



RADIART Sales Offices Across The Nation



These Are The Cities With RADIART Distributors in Iowa, Kansas, Minnesota, Nebraska, North Dakota, South Dakota and Wisconsin. Served By RADIART SALES CO., Minneapolis, Minnesota.

IOWA

- Burlington
- Cedar Rapids
- Council Bluffs
- Des Moines
- Davenport
- Dubuque
- Fort Dodge
- Ottumwa
- Sioux City
- Waterloo

MINNESOTA

- Duluth
- Mankato
- Minneapolis
- St. Paul

NEBRASKA

- Lincoln
- Omaha

NORTH DAKOTA

- Fargo
- Mandan
- Minot

SOUTH DAKOTA

- Rapid City
- Sioux Falls
- Watertown

WISCONSIN

- Appleton
- Chippewa Falls
- Eau Claire
- Green Bay
- Hudson
- Marinette
- Wausau

BUY OF THE MONTH

The RADIART "SEAL-VENT" vibrator is the most important change in vibrator design in 17 years! The famous Radiart "Red Seal" is intact prior to placing the vibrator in use preventing the oxidation of the points. BUT, with the vibrator in use, the wax seal melts permitting the circulation of air into the vibrator extending the performance and life of the vibrator even further.

See your RADIART distributor, or write us

FOR NAME OF YOUR NEAREST RADIART DISTRIBUTOR

USE COUPON BELOW

RADIART SALES CO. 437 Oliver Avenue So., Minneapolis 5, Minnesota

..... Please send names of the Radiart Distributors in my area stocking the following Radiart products in which I am interested: Tele-Rotors, Vibrators, TV and FM Antennas, "Spee-Dee" Chimney Mounts, Lightning Arresters, Auto Aerials, Power Supplies

..... Please have a Radiart Distributor call on me.

Name _____

Address _____

City _____ State _____



THE RADIART CORPORATION CLEVELAND 2, OHIO

VIBRATORS • AUTO AERIALS • TV ANTENNAS • ROTATORS • POWER SUPPLIES

No fuss



When you use Centralab's Exact Replacement Controls



Why waste time "tinkering" with kits . . .



when you can get exact, quickest-for-servicing,
custom replacement controls for TV - AM - FM . . .

There's a Centralab Custom Control — or Standard *Blue Shaft* Unit that's Quickest for Service.

Service Engineers! Centralab's famous Blue Shaft and Custom Controls are exclusive service items. You'll find Blue Shafts available in a complete line of plain and switch types with resistance ranges from 500 ohms to 10 megs. in a wide variety of tapers and

tapped units! All Centralab controls are packaged singly. Blue Shafts are also available in handy plastic boxes of 12 and in a special metal cabinet containing 22 controls. NO EXTRA charge for the cabinet.

Check These LOW PRICES on Popular Blue Shaft Controls!

Cat. No.	Ohms Max. Resistance	Taper	Circuit Location	List Price
B-60	500,000	C-2 (audio)	Volume or Tone	\$1.00
B-60-S*	500,000	C-2 (audio)	Volume or Tone	\$1.50
B-70	1 megohm	C-2 (audio)	Volume or Tone	\$1.00
B-70-S*	1 megohm	C-2 (audio)	Volume or Tone	\$1.50

*Switch Type

Ask your jobber or write direct for Bulletin 42-106 on Blue Shaft Controls. Send 25c for Centralab's TV and Custom Control Guide.

Centralab

Division of GLOBE-UNION Inc.

922 E. Keefe Ave. • Milwaukee 1, Wisconsin

RADIO-ELECTRONICS for

No CUSS



Blue Shaft Controls with attached switches are your smartest service buy! Why? Because they save you valuable bench-working time — by being truly your quickest-for-servicing replacements. These factory attached and tested switches are high amperage, universal units. That means they can be used as SPST — DPST or 3 wire.

For quickest servicing, standardize on Centralab Blue Shaft and Custom Controls.

REMEMBER THESE CBS-HYTRON TV FIRSTS?



16RP4
original *studio-matched* rectangular picture tube.



12BH7
twin-triode sweep amplifier with superior efficiency.



1X2A
compact, high-voltage TV rectifier.



6BQ6GT
25BQ6GT
extra-performance deflection amplifiers.



← **NEW 12BY7**
Very - high - gain miniature pentode amplifier. Gives gains — within its power capabilities — equal to those of 6AG7. As video amplifier, provides better contrast in high-quality TV receivers. And in low-cost receivers, adequate amplification at low plate voltages.



← **NEW 12BZ7**
High-mu, 9-pin miniature dual triode. Especially designed for sync. separators and sync. amplifiers, high-gain audio amplifiers, and gating circuits.



NEW 12A4 →
High-efficiency, medium-mu, 9-pin miniature triode. Used as vertical amplifier, class C oscillator, or low-distortion audio output amplifier in push-pull.



NEW 12B4 →
High-efficiency, low-mu triode with 6/12 volt heater. Designed for vertical amplifiers with limited B supply voltages. Gives more sweep than 6W6GT. In proper circuit, sweeps any 70° rectangular.

**Meet 4 more
CBS-HYTRON
TV Firsts!**

YOU'LL BE SEEING THEM . . . BUYING THEM SOON
Because these tubes are specifically designed for high-performance, low-cost TV for the mass market. Watch for them in new models of famous TV sets. When you buy these CBS-Hytron TV firsts, follow leading set manufacturers. Buy the original. Buy CBS-Hytron!



MAIN OFFICE: SALEM, MASSACHUSETTS

RADIO-ELECTRONICS for

Slight variations in the plate supply voltage will result in frequency change and instability. This must be eliminated; fortunately it's easy with our old friend the VR tube.

Last but not least, put rubber feet on the v.f.o., and place it on a felt pad on the operating table. Now you can pound the key, or the cat can stomp across the floor without that tell-tale "wheep-wheep" on the air!

The v.f.o. circuit

The simplest oscillator is the most satisfactory. There will be fewer adjustments, fewer factors to contend with. Examine the Colpitts circuit and what do we find? A simple coil with no taps, a few capacitors, a resistor and an r.f. choke. On paper it looks like a good bet—and it is. The Clapp circuit is fundamentally a Colpitts even though its proponents may give you a big argument on that score.

Any oscillator can be made to work well. I prefer the Colpitts because it is simple, requires no careful tailoring, and has fewer components. Keying is clean without objectionable clicks or chirps, and the large capacitances used make it easy to obtain excellent frequency stability.

Let's look over Figs. 1 and 2. Fig. 1 is a triode Colpitts oscillator. For stability we want an isolation tube so that any changes reflected back to the oscillator as the amplifier is tuned through resonance will not affect the frequency. Fig. 2 is easy to construct and provides adequate isolation as well. Here, the screen acts as the plate in the frequency determining part of the circuit. The

is unnecessary. Just use an untuned coil with or without an iron core, but tailored for the center of the band in which you want output. For operation on several bands, it is advisable to use a tapped coil with a shorting switch. For single-band operation a common r.f. choke will do the trick. The 6AQ5 will not act as a frequency multiplier unless its output circuit is broadly tuned to the desired harmonic.

Your hoard of parts will probably supply the miniature sockets, resistors, and r.f. chokes needed. Since you will need some silver micas, at least one negative temperature coefficient capacitor, and a .01- μ f bypass, one of the "bargain" assortments of fixed capacitors would be a good investment. A screw-driver adjusted ceramic trimmer, perhaps 2 to 9 μ f, will aid in hitting the correct tuning range. Under no conditions should a compression type trimmer be used as its capacitance varies widely with changes in temperature or humidity. If you buy any new components get the smallest that you can, including the double-bearing midget tuning capacitor—about 50 μ f capacitance depending on the frequency coverage and band spread desired.

The grid-circuit frequency determining inductance is important. Don't use an air-wound coil. Even the B & W Miniductors lack the necessary rigidity in this application. If your parts hoard lacks a substantial coil wound on a form, either look over the magazine advertisements or visit your local surplus store. You can obtain an assortment of factory-wound coils for thirty to fifty cents, or, with luck, at from three to ten cents each. Something about an inch in diameter and with perhaps twenty turns is needed. Be sure that the coil form can be securely fastened to the chassis. An assortment is a good investment, as many uses can be found for them and you will have several to experiment with when designing your v.f.o. If you use the Colpitts circuit no tap on the coil is necessary. Feedback voltage comes from the tap between the two series-connected capacitors.

Referring to Fig. 3, C2, C3, and C5 should be silver mica and C4 a negative temperature coefficient type; and C6, C7, C8, and C9 may be those dime-size disc ceramic capacitors. If C1 is much larger than 35 μ f, C3 may have to be

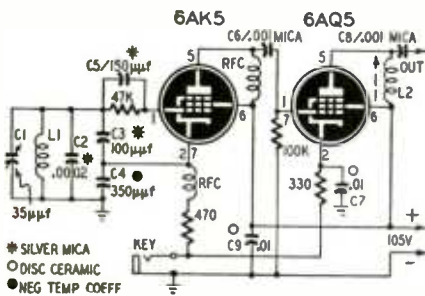

Fig. 3—Complete circuit of the v.f.o.

isolation stage is electron coupled to the oscillator through the electron flow from the cathode to the screen and plate. What tube to use? My choice is the miniature 6AK5, whose low filament current and adequate output at low plate voltage makes it a "natural" for my money.

My v.f.o. is constructed for frequency determination and not for power. To drive the grid of an 807 a little more power is needed than can be obtained from a 6AK5 with 105 volts on the plate and screen. A 6V6 is good, but too large physically. The optimum choice seems to be the 6AQ5, a miniature 6V6. This tube, with only 105 or 150 volts on the plate and screen, will adequately drive the grid of an 807 regardless of whether it is amplifying straight through, doubling, tripling, or quadrupling.

A tunable plate circuit for the 6AQ5

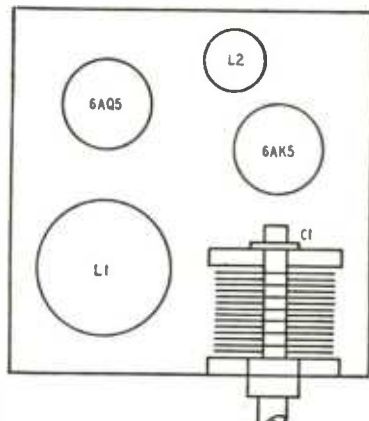
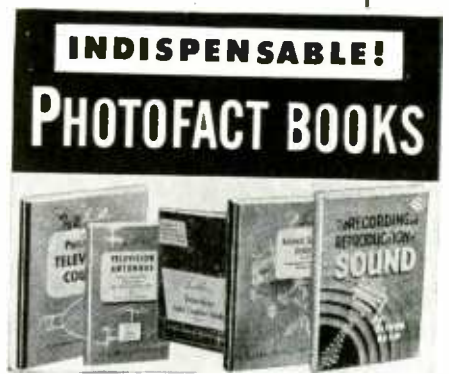

Fig. 4—Top view of the chassis layout.



- Photofact Television Course.** Covers TV principles, operation and practice. 216 pages; profusely illustrated; 8 1/2 x 11". Order TV-1.....Only \$3.00
- Television Antennas.** New 2nd edition. Describes all TV antenna types; tells how to select, install, solve troubles. Saves time; helps you earn more. 200 pages; illustrated. Order TAG-1.....Only \$2.00
- Television Tube Location Guide.** Volume 2. Accurate diagrams show position and function of all tubes in hundreds of TV sets; helps you diagnose trouble without removing chassis. 224 pages; pocket-size. Order TGL-2. Only \$2.00
- Television Tube Location Guide.** Vol. 1. Over 200 pages of TV receiver tube position diagrams on hundreds of models. Order TGL-1.....Only \$1.50
- Making Money in TV Servicing.** Tested proved methods of operating a profitable TV service business. Covers all important phases. Authoritative, valuable guide to success. Over 130 pages. Order MM-1.....Only \$1.25
- Servicing TV in the Customer's Home.** Shows how to diagnose trouble using capacitor probe and VTVM. Short-cut methods help save time, earn more on outside service calls. Order TC-1.....Only \$1.50
- 1949-1950 Record Changer Manual.** Vol. 3. Covers 44 models made in 1949, including multi-speed changers and wire and tape recorders. Original data based on actual analysis of equipment. 286 pages; 8 1/2 x 11"; paper-bound. Order CM-3.....Only \$3.00
- 1948-1949 Changer Manual.** Vol. 2. Covers 45 models made in 1948-49. Paper bound. Order CM-2. Only \$4.95
- 1947-1948 Changer Manual.** Vol. 1. Covers 40 post-war models up to 1948. Order CM-1.....Only \$3.95
- Recording & Reproduction of Sound.** A complete authoritative treatment of all phases of recording and amplification. 6 x 9". Order RR-1.....Only \$5.00



- Audio Amplifiers.** Vol. 3. Clear, uniform, accurate data on 50 important audio amplifiers, plus full coverage of 22 FM and 10 AM models covered during 1950. 362 pages, 8 1/2 x 11". Order AA-3.....Only \$3.95
- Audio Amplifiers.** Vol. 2. Clear, uniform, accurate data on 104 well-known audio amplifiers, plus full coverage of 22 FM and 10 AM models covered during 1950. 362 pages, 8 1/2 x 11". Order AA-2.....Only \$3.95
- Audio Amplifiers.** Vol. 1. 102 amplifiers and 10 AM models made through 1948. 352 p. Order AA-1.....Only \$3.95
- Auto Radio Manual.** Complete service data on more than 100 post-war auto radio models. Covers over 24 mfrs. 350 pages, 8 1/2 x 11". Order AR-1.....Only \$4.95
- Communications Receiver Manual.** Complete analysis of 50 popular communications models. 246 pages, 8 1/2 x 11". Order CR-1.....Only \$3.00
- Radio Receiver Tube Placement Guide.** Accurate diagrams show where to replace each tube in 5500 radio models, covering 1938-1947 receivers. 192 pages, pocket-size. Order TP-1.....Only \$1.25
- Dial Cord Stringing Guide.** Vol. 2. Covers receivers made from 1947 through 1949. Shows you the one right way to string a dial cord in thousands of models. Pocket-size. Order DC-2.....Only \$1.00
- Dial Cord Guide.** Vol. 1. Covers sets produced 1938 through 1946. Order DC-1.....Only \$1.00

Order from your Parts Jobber or write direct to
 HOWARD W. SAMS & CO., INC., 2201 E. 46th St., Indianapolis 5, Indiana
HOWARD W. SAMS & CO., INC.

AGAIN AVAILABLE!
At No Increase in Cost

OHMITE Little Devil
1/2-WATT RESISTOR ASSORTMENT
—In Plastic Cabinet For Cost of Resistors Alone!

COST OF RESISTORS ALONE
\$1250
NO CHARGE FOR CABINET

Again you can get this handy, all-plastic resistor cabinet with the OHMITE Little Devil 1/2-watt resistor assortment—at the regular price of the resistors alone. This handsome cabinet is a real timesaver in your shop... makes it easy to find the right resistor in seconds, and you have a

visual control of your stock—eliminating duplicate inventories and unnecessary trips to your distributor. Extremely compact (9" x 5 1/4" x 4 3/4") the sturdy cabinet has five drawers, with eight compartments in each drawer—a separate compartment for each resistance value.

TIME-SAVING CABINET CONTAINS 125 RESISTORS IN 40 COMPARTMENTS

NO MORE GUESSWORK!

RESISTANCE AND WATTAGE CLEARLY MARKED ON EVERY UNIT

Each one of these tiny, rugged, Little Devil units is not only color coded, but clearly imprinted with resistance and wattage values. No more mistaken identity!

Little Devils are available in 1/2, 1, and 2-watt sizes, $\pm 5\%$ or $\pm 10\%$ tolerance, in standard RTMA values from 10 ohms to 22 megohms. In the 1-watt size, $\pm 10\%$ tolerance, values as low as 2.7 ohms are available.

The forty compartments are factory-packed with a selected servicemen's assortment of 125 individually marked, 1/2-watt Little Devil Insulated Composition resistors, in 40 values from 10 ohms to 10 megohms, $\pm 10\%$ tolerance. These tiny, dependable units are known the world over by servicemen, amateurs, and engineers as the ultimate in ruggedness, stability, and current-carrying capacity.

ASK YOUR DISTRIBUTOR—TODAY!

OHMITE MANUFACTURING CO.
4895 Flournoy St., Chicago 44, Ill.

Be Right with **OHMITE**
RHEOSTATS • RESISTORS • TAP SWITCHES

increased and C4 decreased for stable operation over the tuning range. Coil L1 has 20 turns of No. 14 enameled wire on a 1 1/2-inch form for the 3500-to-4000-kc range. L2 is wound with No. 20 enameled wire on a 1/2-inch diameter form. For 80, 40, and 20 meters, respectively, the windings are 40, 20, and 9 turns close-wound and doped with a low-loss material such as Polyweld 912, Q-Dope, Quartz-Q, etc.

Find the approximate inductance from the coil table in the handbook, and determine from the chart what capacitance is needed for 3750 kc (or the center of the band that you want the v.f.o. to operate on). Juggle your capacitors on the coil until you hit the right frequency range as determined by a grid-dip meter or a calibrated re-

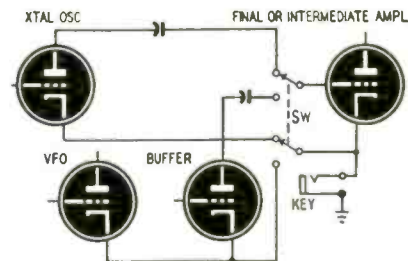

Fig. 5—The switching and keying circuit.

ceiver with the antenna disconnected. A good starting point is 100 μf for C3, 300 μf for C4, and 200 μf for C2. The variable tuning capacitor and the optional ceramic trimmer should parallel C2. One of the fixed capacitors, preferably C3, should be a negative temperature coefficient type.

Fig. 3 shows the schematic of the unit constructed by the author from his collection of parts. Component values are given. All the parts can be mounted on a little chassis 3 inches square and 3/4 inch high. Your local tinsmith can cut and bend a piece of 1/16-inch sheet aluminum of the proper size which should fit in an odd corner of your present driver stage. Fig. 4 shows the approximate placement of the components on top of the chassis. Others not shown are underneath. It may seem like *mucho* work, but don't forget that there's a lot of self-satisfaction in designing and building your own gear.

Constructional hints

When you tailor your 6AQ5 plate coil to resonate in the center of the band, or bands desired, check it with your grid-dip meter after it is connected in the circuit, as tube and stray capacitances affect it considerably.

To trim up the frequency determining tank adjust the ceramic trimmer (about 2 to 9 μf , not shown in Fig. 3 or 4), mounted on top of the tuning capacitor, so that there is equal dial space above and below the band. This trimmer is, of course, in parallel with C1 and C2 in Fig. 3.

Have the rig well shielded, and don't forget the shields for the miniature tubes and the coils. If you drive an 807, it must be well shielded. To eliminate any tendency for it to take off as a t.p.t.g. oscillator, one or more of the

following procedures may be adopted as necessary:

1. Run the output lead from the v.f.o. in large-diameter shielded wire (well grounded) to the 807.
2. Insert a 1-watt resistor, 50 or 100 ohms, wound full of No. 26 wire, in the plate lead.
3. Insert a 47-ohm 1/2-watt resistor in the screen lead at the socket.
4. Add a 47-ohm 1/2-watt resistor in the lead to the 807 control grid.

If you wish to retain your present crystal oscillator for network use, add a switch to throw the keying and output to either the crystal or the v.f.o. unit. A d.p.d.t. rotary switch connected as shown in Fig. 5 will give you more versatile operation.

Unless fixed bias is used on the 807, its cathode should be keyed simultaneously with the cathode of the v.f.o. (or the crystal stage). It is generally simpler to key the 807 cathode than to provide the 45 or so volts of negative bias to cut off the 807 plate current in the absence of excitation.

The most important thing to remember in v.f.o. construction and design is *mechanical rigidity*. If you bear that in mind every time you fasten down a component or solder a connection, all your troubles will be little ones.

(The actual value and coefficient of C4 will depend on the average temperature of the room, the temperature within the v.f.o. enclosure, and temperature variations of the oscillator tube under varying line voltages. Room-temperature variations can be licked by enclosing the oscillator in an air-tight aluminum shield can lined with thermal insulating material.—*Editor*)

—end—

HARMONIC XTAL OSCILLATORS

Several of the commonly used harmonic-type crystal oscillators have a tuned circuit in series with the cathode return. This tuned circuit must be shorted out to prevent damaging the crystal when fundamental output is desired. Forgetting to short this coil often results in damaging the crystal.

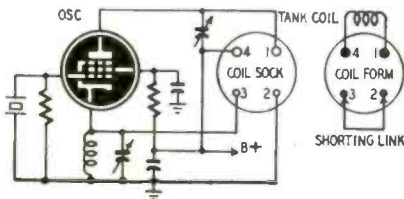

I have minimized this danger by making the circuit connections shown in the drawings. A lead from the oscillator cathode is run to one of two unused terminals on the socket for the plug-in plate coil. The other unused terminal is grounded. A jumper is connected between corresponding pins on the plug-in coil used for *fundamental output*. Now the cathode coil is automatically shorted out when the fundamental tank coil is plugged in. This trick is useful only when all the available crystals are in the same band.—*S. H. Beverage, W1MGP*

FEBRUARY, 1952

Directronic

MOTORLESS TV AERIAL SYSTEMS

360° ELECTRONICALLY SWITCHED BEAM

GIVES SAME CLEAR PIX AS MOTOR DRIVEN AERIALS AT 1/3 THE COST

SIMPLE FLICK OF SWITCH
CLEARS PICTURE **INSTANTLY**
NO WAITING

OPENS BIGGEST REPLACEMENT MARKET IN TV HISTORY

MAIL THIS COUPON TO-DAY!

SNYDER MFG. CO.

23rd & Ontario Sts., Phila. 40, Pa.

Please send me free copy of authoritative booklet TENNA TIPS on Directronic and all other types of aerials, plus catalogs.

NAME _____
ADDRESS _____
CITY _____ ZONE _____ STATE _____

Life-like window displays and counter cards!



Bright exciting streamers!



Personalized postal cards. Giant mailers! Radio announcements and reminder stickers!

STOP! DON'T PASS THIS PAGE

... until you've read about SYLVANIA'S power-packed Service-Dealer Campaign

Talk about an exciting, sales-building Radio-TV Service Dealer campaign! Mister, this is it! Featuring personal endorsements of some of the most glamorous and newsworthy people in the entire country, this campaign ties you in with big-space ads in *Life*, *The Saturday Evening Post*, *Collier's* and *Better Homes and Gardens*.

Just see what you get: . . . brilliant life-like cut-outs of the celebrated stars . . . counter cards, streamers, appealing mailers . . . also radio spot announcements, and reminder stickers. You pay only two cents per prospect per month for the mailers. The rest is FREE. Don't delay! Call your Sylvania distributor or mail coupon N-O-W!



Sylvania Electric Products Inc.
Dept. R-2702, Emporium, Pa.

I'd like full details about Sylvania's big 1952 Campaign for Service Dealers.

Name _____

Street _____

City _____ Zone _____ State _____

SYLVANIA

RADIO TUBES; TELEVISION PICTURE TUBES; ELECTRONIC PRODUCTS; ELECTRONIC TEST EQUIPMENT; FLUORESCENT TUBES, FIXTURES, SIGN TUBING, WIRING DEVICES; LIGHT BULBS; PHOTOLAMPS; TELEVISION SETS

GIANT TV SALE

Save on Chassis, Tubes, Cabinets, Accessories, etc.

NEW—THE SENSATIONAL 630-DX CHASSIS

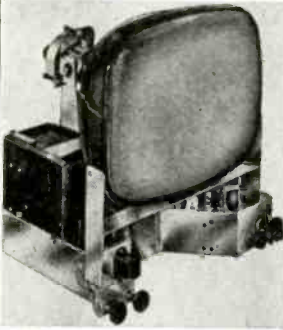

Amazing Low Price!
30-Tubes—RCA lic.—For 16" to 24" Picture Tubes. **FINEST CHASSIS AVAILABLE At Any Price!** For long range and best reception up to 200 miles without a complicated booster or antenna, this new, advanced 630 DX Chassis gives 3-times normal reception. Special extra-high gain standard coil tuner offers greater sensitivity, top performance on any channel; aligned & tested for 5 hours; molded condensers; 4 microvolts sensitivity; Armstrong FM sound system; horizontal & linear lock and is directly adaptable for color and UHF. This is the very best Chassis buy—order NOW at this low-low price! You can't beat it!

RMA Guaranteed—Factory Wired \$159.95 (Incl. Fed. Tax—less CRT)
Complete, ready to play including 12" speaker, hardware and knobs:

630 Standard Chassis, complete \$144.50 (Incl. Fed. Tax—less CRT)

FREE! With any chassis, a copy of the famous "TV Trouble Shooting Method," locate all troubles in a jiffy. Complete with illustrations and hundreds of rapid checks. Get yours **NOW—FREE!**

TV TUBE ACCESSORIES—ANTENNAS

Each Specially Priced!

Universal Mounting Bracket, \$6.97	All Aluminum Conical Antennas \$3.29 ea.
Sleeve & Ring for 16" Metal 3.85	Lots of 12—\$2.69 ea.
Sleeve & Ring for 19" " 4.04	All Aluminum "Vee" Type Antenna \$3.29 ea.
Sleeve & Ring for 24" " 7.95	Lots of 12—\$2.69 ea.

LUXURIOUS, NEW TV CABINETS

For 630 Chassis, 17", 19", & 20" Picture Tubes

Model 100 Reduced to \$39.95



Save 45%! Custom Styled



Model 200 Now only \$49.50

Blonde finish add \$10

Every beautiful cabinet, in richly finished, hand rubbed mahogany will stand out in any room. Made special to house the 630 chassis, they will carry a 17", 19" or 20" picture tube. Every cabinet is custom styled, made by craftsmen and guaranteed perfect. Includes safety glass, mask & mounting brackets. Order Now and Save 45%!

All Prices Reduced! CRYSTAL CLEAR LUCITE MASKS

Framed in Rich Gold Leaf Finish
RO—Round Tubes
RE—Rect. Tubes

14" RE 10 1/2" x 13 1/4"	\$4.49
16" RE 12 1/4" x 15 3/4"	5.79
16" RO 13 1/4" x 17"	5.89
17" RE 13 1/4" x 17"	5.89
18" RO 15 1/4" x 20"	7.69
20" RE 16 1/4" x 20 1/4"	7.69
24" RO 21" x 25"	13.95

TV PICTURE TUBES

6-Months Guarantee—non pro-rata
Black Face—Brand New—Standard Brands—

Sealed Cartons			
10BP4 RO-G	\$24.95	16HP4 RO-G	\$33.95
12LP4 RO-G	24.95	17BP4 RE-G	29.95
14BP4 RE-G	24.95	19AP4A RO-M	37.95
16GP4 RO-M	31.95	20CP4 RE-G	37.95
		24AP4 RO-M	69.95

NOW! Write for FREE Catalog including new complete line of tubes, parts, accessories for radio & TV, plus test instruments.

MINIMUM ORDER: \$5.00. 25% deposit with order, balance C.O.D. Include postage with order. All merchandise subject to prior sale, F.O.B. New York City. Prices subject to change without notice.



THE ROSE COMPANY

100 Park Place

Dept. E-2, New York 7, N. Y.

COrtlandt 7-6195

Get This Valuable Book

Just for Examining COYNE'S New 6-Volume Set

FREE



"Applied Practical Radio-Television"

Yes, you get this big, brand new book, "150 Radio-Television Picture Patterns and Diagrams Explained", absolutely FREE! Just off the press! Gives complete wiring circuits and diagrams on the latest Radio and Television Sets. Easy-to-read, large 8 1/4 x 11" pages, with full instructions on how to read and use the diagrams. A "must" in every Radio and Television service-man's repair kit. You get this valuable book as a FREE Gift for asking to see Coyne's great new 6-book set, "Applied Practical Radio-Television"!

Here's "Know How" that Makes You Worth More!

You'll get into the big money faster in TELEVISION-RADIO if you know where to find the answer to servicing problems. Coyne's great new 6-volume set gives you all the answers—quickly! For basic "know-how" that is easy to understand, you'll find everything you want in volumes 1 to 5 which contain over 5000 practical facts and data. They cover every step from principles to installing, servicing, trouble-shooting and aligning all types of radio and TV sets. So up-to-date it includes COLOR TV and UHF, adapters and converters.

And then, for speedy on-the-job use, you get volume 6—the famous Coyne TELEVISION CYCLOPEDIA. It answers today's television problems on servicing, alignment, installation and others. In easy-to-find ABC order, cross indexed. Use this 6 volume TV-RADIO LIBRARY free for 7 days; get the valuable Servicing Book ABSOLUTELY FREE!

ON 7 DAYS FREE TRIAL!



SEND NO MONEY! Just mail coupon for 6-volume set on 7 days free trial. We'll include book of 150 TV-Radio Patterns & Diagrams. If you keep the set, pay \$3 in 7 days and \$3 per month until \$23.00 plus postage is paid. (Cash price \$22.00). Or you can return the library at our expense in 7 days and owe nothing. **YOU BE THE JUDGE. Either way, the book of TV-Radio Patterns is yours FREE to keep!** Offer is limited. Act NOW!

FREE BOOK—FREE TRIAL COUPON!

COYNE ELECTRICAL & TELEVISION-RADIO SCHOOL, Dept. 22-T1
500 S. Paulina St., Chicago 12, Ill.

YES! Send 6-volume "Applied Practical Radio-Television" for 7 days FREE TRIAL per your offer. Include TV-Radio Patterns & Diagram Book FREE.

Name..... Age.....

Address.....

City..... Zone..... State.....

Where Employed.....

() Check here if you want library sent COD. You pay postman \$22 plus COD postage on delivery. 7-day money-back guarantee.

COYNE ELECTRICAL & TELEVISION-RADIO SCHOOL
500 S. Paulina St., Dept. 22-T1 Chicago 12, Ill.

Safety ALL WAYS

with **AMPHENOL**

INLINE ANTENNA

Because your TV antenna is continually being exposed to the rigors of Mother Nature—wind, ice and storm—choosing an antenna that is structurally strong is very important. The Amphenol Inline Antenna is engineered to repeatedly withstand winds of 70 miles per hour and one-half inch annular ice loadings. It is clean in design and presents no surface unduly exposed to wind. Its aluminum construction is strong and light in weight. In addition, the aluminum is rust and corrosion resistant and is especially suited for use in sea coast areas and other places where salt or other corrosive conditions are encountered.

LIGHTNING ARRESTOR

The National Electric Code states that every unshielded outdoor antenna lead-in should have an approved lightning arrester. The Amphenol Lightning Arrestor is approved for this purpose and also carries the Underwriters' Laboratories seal of approval. It eliminates the danger of lightning causing damage to your TV set or home and also carries off the minor static discharges that interfere with good picture reception.



AMERICAN PHENOLIC CORPORATION
1830 SOUTH 54th AVENUE • CHICAGO, ILLINOIS

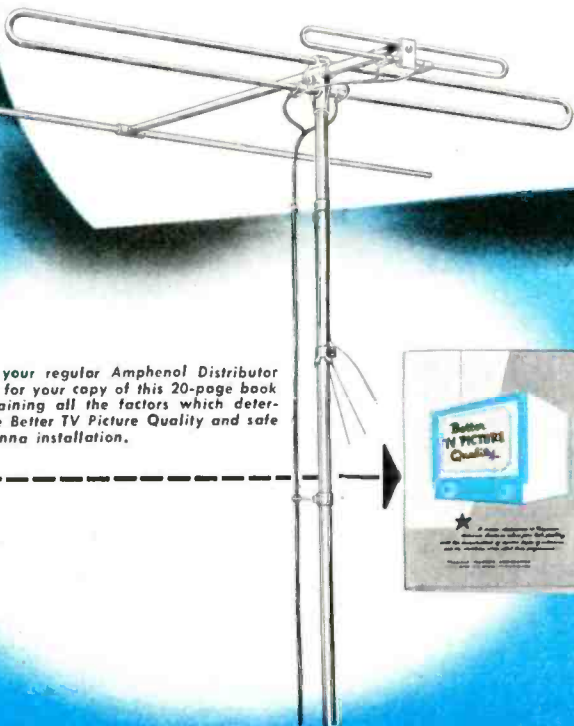

See your regular Amphenol Distributor now for your copy of this 20-page book containing all the factors which determine Better TV Picture Quality and safe antenna installation.



New Devices

COMPACT RELAY

Advance Electric and Relay Co., 2435 North Naomi St., Burbank, Calif., has announced production of a light-weight, precision built relay to strict military specifications for the U.S. Signal Corps. It is designed to operate over a temperature range of minus 60°F to plus 150°F at continuous duty, breaking motor loads up to 50 amperes at 28 v.d.c. Coil windings for operation at from 3 to 230 v.d.c. are available. Weighing only 9¼ ounces, the relay measures 1⅞ x 1½ inches wide x 2¾ inches long.

HI-VOLT CAPACITORS

Aerovox Corporation of New Bedford, Mass., has added a line of new tubular ceramic capacitors rated at 6,000 volts breakdown. The type SI-TV are of the Hi-Q brand manufactured by The Electrical Reactance Corp., an Aerovox subsidiary, available in eleven capacitance values from 4.7 to 47 µmf for jobber distribution to the service and experimenter trade. These, as the other Hi-Q ceramic capacitors, come packed five to a special window carton.

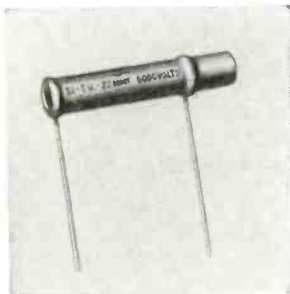

METAL CABINETS

Insuline Corp. of America, 36-02 35th Ave., Long Island City 1, N. Y., announces a new line of small utility metal cabinets which feature removable front and back covers. Especially intended for amplifiers, monitors, test sets, control units, miniature receivers and transmitters, etc., the cabinets range in size from 4 x 2 x 4 inches to 12 x 11 x 8 inches, and are available in natural and gray aluminum, and in black ripple steel. The covers are fastened with self-tapping screws, which are included.

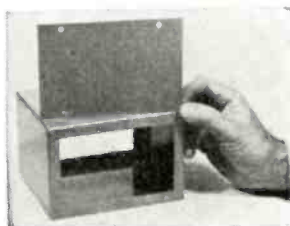

TV COMPONENTS

Standard Transformer Corporation, 3580 Elston Ave., Chicago, announces two new television components, a high-efficiency deflection yoke DY-10, and a high-voltage flyback transformer A-8131. These are companion units used in direct-drive circuits. They are exact replacements in 34 RCA, 30 Emerson, and 7 Capehart TV models.

The DY-10 is an anti-astigmatic yoke with cosine windings and nylon insulation, designed to provide a sharp, well focused picture over the entire tube face.



TWO YAGI ANTENNAS

Ward Products Corp., Division of The Gabriel Co., 1523 East 45th St., Cleveland 3, Ohio., has introduced two new Yagi type antennas for the 450-470 mc band. Both units are of painted, copper-plated steel, equipped with matching harnesses, and shipped pre-assembled for rapid installation.

The model SPP-161 (illustrated is a 12-element antenna) matches 52 ohms with a voltage standing-wave ratio of less than 2 to 1, can handle up to 250 watts of power, and is vertically polarized for commercial communications. There is provision for horizontal polarization if needed.

The model SPP-172 is a 24-element antenna having a forward gain of 14.5

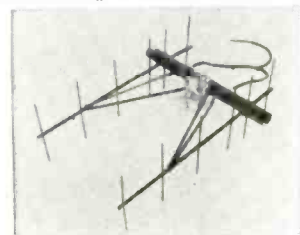

db. It is constructed like the SPP-161 which has a forward gain of 11 db.

CRYSTAL R.F. PROBE

Precise Development Corp., Oceanside, L. I., N. Y., has introduced a new r.f. probe, model 912, 6½ inches long and housed in a specially constructed non-porous case. It uses a germanium crystal rectifier. The probe handle terminates in an Amphenol connector while the other end of the RG59U



shielded cable is available with either an Amphenol phone plug or phone tip type of fitting at an additional cost. This probe may be used with vacuum-tube voltmeters, multimeters, or oscilloscopes as an adjunct for experimenting or trouble-shooting.

The useful frequency range is from low audio frequencies through 250 mc; practically flat through 100 mc. It reads the r.m.s. value of a sine wave. A.C. readings are linear up through 20 volts peak. D.C. blocking permits measurements of the r.f. voltage present in circuits having up to a peak of 600 volts, d.c. Approximate input capacity is 3 µmf while the input resistance is 200,000 ohms at one megacycle, 150,000 ohms at 10 mc and 25,000 ohms at 100 mc. (Input resistance figures are approximate.)

SWITCHING BOOSTER

Tel-a-Ray Enterprises, Inc., of Henderson, Ky., has introduced an antenna switching booster which amplifies the signals from any one of four selected single-channel antennas, for improved fringe area reception.

Four sets of terminals supplying 6.7 volts a.c. for operation of up to four antenna-mounted preamplifiers, are mounted adjacent to the four antenna input terminals and are gang-switched from the front. The 6J6 amplifier gives high gain with a low noise level with full bandwidth on all channels. The booster is automatically switched on and off with the receiver, and if the antenna pickup is naturally high the amplifier may be bypassed.

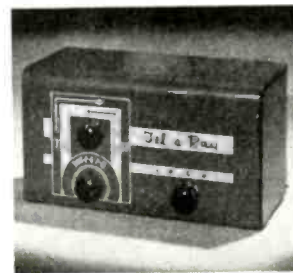

RADIO-ELECTRONICS for

TELEMETER RECORDER

Ampex Electric Corp., Redwood City, Calif., announces another special magnetic tape recorder, model 307, designed to record original telemetered data from aircraft and missiles. The new recorder has a frequency range of from 100 to 100,000 cycles per second, thereby permitting the recording of all FM/FM telemetering channels recommended by the Telemetering Panel of The Research and Development Board. A tape speed of 60 inches per second in addition to the usual 30 and 15 inches per second aids in extending the frequency range and permits the recording of data previously handled only by a cathode-ray oscilloscope and moving film camera.



ACOUSTIC SPEAKER LENS

James B. Lansing Sound, Inc., 2439 Fletcher Drive, Los Angeles 39, Cal., is producing the type 175 DLH acoustical lens designed for use with the type 175 high-frequency driver unit. The lens distributes a uniform sound wave over the entire audio spectrum while smoothing out the highs. The lens is not frequency-sensitive because its bandwidth is wider than the audio spectrum in which it is used.



All specifications given on these pages are from manufacturers' data.

NEW V. T. V. M.

The Hickok Electrical Instrument Co., 10531 Dupont Ave., Cleveland 8, Ohio, has announced a v.t.v.m., model 215, in a heat, shock, and acid resistant case with a 5-inch meter in a Lucite case. The unit features a dual purpose a.c.-d.c. probe with built-in switching. The ranges are:

D.c. volts in seven ranges to 1,200 volts at $\pm 13\%$ with 10 megohms input resistance. Zero center scale adjustment.

A.c. volts (r.m.s.) in seven range to 1,200 volts seven ranges (peak-to-peak) to 3,200 volts. Frequency response flat from 40 cycles to 3.5 mc with optional crystal probe for use up to 250 mc. Accuracy $\pm 5\%$ with 30



megohms shunted by 150 μ f input impedance.

Ohmmeter ranges 0 to 1, 10, 100, 1000, 10,000, 100,000, and 1 megohm with readability from .2 ohms to 1,000 megohms. Scale center is 10 ohms.

Weight is 4 1/2 lbs. net, and case is 8 3/4 x 5 3/4 x 4 1/2 inches. The handle is of neolite.

ANTENNA ROTATOR

Viking Tool and Machine Corp., of Belleville, N. J., has announced an impulse motor type antenna rotator. Corrosion resistant materials and a starting torque of 50 inch-pounds assure trouble-free performance under icy and adverse weather conditions. It is supplied with an attractive remote control box and an optional antenna direction indicator.

—end—

SAVE

THAT GOOD LOOKING OLD CONSOLE—
REPLACE THE OBSOLETE RADIO

with a modern, easily installed

ESPEY AM/FM CHASSIS

and your favorite console is "right-up-to-date"



Rated an excellent instrument by America's foremost electronic engineers. Fully licensed under RCA and Hazeltine patents. The photo shows the Espey Model 511-C, supplied ready to play. Equipped with tubes, antenna, speaker, and all necessary hardware for mounting.

NEW FEATURES—Improved Frequency modulation circuit, drift compensated • 12 tubes plus rectifier, and pre-amplifier pick-up tubes • 4 dual purpose tubes • High quality AM-FM reception • Push-pull beam power audio output 10 watts • Switch for easy changing to crystal or variable reluctance pick-ups • Multi-tap audio output transformer supplying 4—8—500 ohms.

Write Dept. RC-2 for literature and complete specifications on Model 511-C and others.

Makers of fine radios since 1928.

ESPEY
MANUFACTURING COMPANY, INC.
578 EAST 72nd STREET, NEW YORK 21, N. Y.

PLEASE MENTION RADIO-ELECTRONICS
WHEN WRITING ADVERTISERS

RADIO COURSE

\$2.50
COMPLETE

SPECIAL OFFER
READ THE DETAILS

WORTH MUCH MORE

"You should get more money for your course. The first week I studied it, I made \$10.00 repairing sets. I built my own test outfit from details given in this course. I have repaired 100 radios to date. . . ."
Signed: Robert C. Hammel, 120 W. 13th, Davenport, Iowa.

COMPLETED IN 8 WEEKS

"I am very satisfied with the course. When I was at the twelfth lesson I started repairing radios. It took me two months to master your course."
From a letter written by Roger Lanziois, 1679 Poupart, Montreal, Canada.

AMAZING BARGAIN IN HOME TRAINING

Here is your practical home-study course at a give-away price. The 22 lessons cover all topics just like other correspondence radio courses selling for over \$150.00. Our amazing offer permits you to obtain the course complete for only \$2.50, nothing else to pay. Course covers fundamentals, modern circuits, practical radio repairs. Includes hundreds of diagrams, thousands of repair hints, many trouble-shooting short-cuts.

RADIO TRAINING FOR HOME-STUDY

The easy-to-follow lessons of this home-study course will show you quickly how to repair all types of radio sets. Every lesson is well illustrated, interesting to read, really easy to understand and apply. No special previous knowledge is needed. The early lessons explain important principles. Other lessons cover test equipment, trouble-shooting, circuit tracing, television, and every important topic or radio servicing.

PRACTICAL ON-THE-JOB MATERIAL

Learn new speed-tricks of radio fault-finding, case histories, servicing short-cuts, extra profit ideas. Included are many large lessons on the use of regular test equipment, explanation of signal tracing, use of oscilloscope, transmitters, P. A., television, recorders, etc.

EASY TO UNDERSTAND AND APPLY

The practical lessons of this course-manual are easy to follow and apply to actual radio jobs. Hundreds of radio and television facts that puzzled you will be quickly cleared up. Every new radio development of importance and thousands of time-saving facts are packed into this giant-size complete course-book recently published.

YOUR SATISFACTION GUARANTEED

Use the no-risk coupon below to order Course for 10-day examination in your own home. Look over this material, read a few lessons, use this aid to fix a few radios. Only then decide to keep the lessons at the bargain price of \$2.50 (full price), or return the material for a cash refund.

NO-RISK TRIAL ORDER COUPON

SUPREME PUBLICATIONS, 3727 W. 13 St., Chicago 23, ILL.

Send the manuals checked below and at right. You guarantee satisfaction or money back.

- Radio Course, complete full price only . . . \$2.50
- New 1951 Television Service Manual . . . \$3.
- 1950 Television Manual, \$3. 1949 TV, \$3.
- 1948 TV, \$3. 1947 TV & FM only \$2.

- I am enclosing \$ Sent postpaid.
- Send C.O.D. I am enclosing \$. . . deposit.

Name:

Address:

- Radio Diagram Manual's
- New 1951 Manual } Each Only
- 1950 Radio Manual } \$2.50
- 1949 Radio Manual }

PRICED AT ONLY \$2 EACH



Supreme Radio & TV Manuals

Your complete source of all needed RADIO and TV diagrams and service data. Most amazing values. Still sold at pre-Korean prices. Only \$2 for most volumes. Every Radio manual contains large schematics, all needed alignment facts, parts lists, voltage values, trimmers, dial stringing, and service hints. Each TV manual is a practical treatise on servicing the year's sets, with giant blueprints, patterns, waveforms, charts, suggested changes. See coupon at right for a complete list of these low-priced manuals.

Supreme Publications

Sold by All Leading Radio Jobbers



● THAT CAN'T BE DUPLICATED

Workshop Associates' pioneering leadership individualizes all products to a superlative degree that defies duplication. Laboratory-tested engineering confirmed by field technicians everywhere. Like fingerprints, you can always tell the difference.

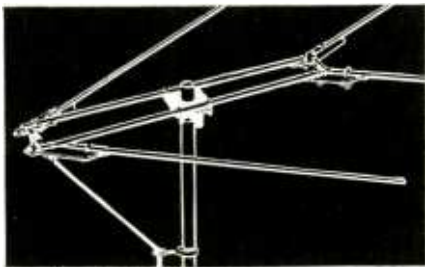

the WORKSHOP DUBL·VEE TV ANTENNA

Developed and Patented by Workshop

Widely imitated. . . never equalled . . . preferred everywhere. Rugged, durable, extra strength to withstand the toughest weather conditions . . . assures clearer pictures . . . higher gain . . . high signal strength . . . no ghosts. Write for catalog.

*Specialists in High Frequency
Electronics*



**THE
WORKSHOP
ASSOCIATES**
Division of the Gabriel Co.
135 Crescent Road
Needham Heights 94, Mass.

1-Tube Loudspeaker Radio

By H. W. SECOR

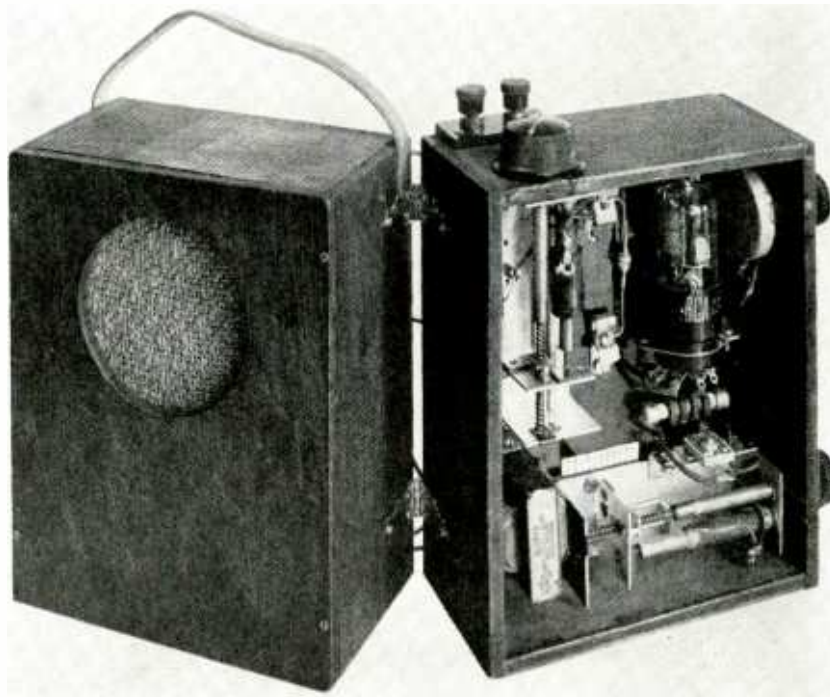

Tuning arrangement, controls, and parts layout are easily seen in this photo.

This latest attempt at a 1-tube radio which will operate a speaker uses some new circuits.

DESIGNING a 1-tube receiver for the broadcast band has long been a favorite sport of the advanced constructor (and even of some would-be manufacturers). In spite of the new tubes developed in recent years, the task is still not easy. A great deal more gain and power is needed for even a small speaker than for excellent head-phone reception.

This circuit was evolved after experiment with a host of tubes. Best results were obtained with the 1D8-GT, though a 3Q5-GT pentode worked reasonably well. Hookups for both tubes are shown. Both tubes were worked in a reflex circuit, with a 1N34 crystal detector.

The 1D8 requires only a single flash-light cell for the filament and about 67.5 volts on the plate. Up to 110 volts was tried—with and without bias—but there was not enough increase in gain to justify the extra voltage.

The circuit action

The signal from the antenna—selected by slug tuner A—is first applied to the 1D8's triode grid, is amplified by that section of the tube and is passed on to the 1N34 detector through a 100- μ f capacitor. (See Fig. 1.) Slug tuner B in the triode's plate circuit maintains it at a high level. The rectified signal is again applied to the triode grid through the two 470,000-ohm resistors. The 15- μ f capacitor bypasses any remaining r.f. to ground.

Reappearing at the triode plate, the signal—now at audio frequency—passes through the primary of the a.f. transformer. Its secondary is across the control grid of the pentode section.

Regeneration helps to strengthen the signal, and may be adjusted to some extent with slug tuner B. However, with the present component values, there is no oscillation. Additional control of vol-

RADIO-ELECTRONICS for



LEARN PRACTICAL RADIO AT HOME!

COMPLETE, FOR ONLY **\$19⁹⁵**

Build 15 Radios

Build a Professional Signal Tracer
Build a Code Oscillator
and Learn Code!



FREE!

- ELECTRICAL AND RADIO TESTER
- RADIO TELEVISION SERVICING LESSONS
- BOOK ON TELEVISION
- MEMBERSHIP IN RADIO-TELEVISION CLUB
- ELECTRIC SOLDERING IRON
- CONSULTATION SERVICE
- QUIZZES

10-DAY MONEY BACK GUARANTEE

ABSOLUTELY NO PREVIOUS TRAINING NEEDED • FREE TOOLS • NO ADDITIONAL PARTS REQUIRED
YOU KEEP ALL PARTS, TOOLS, INSTRUCTIONS • AN EXCELLENT BACKGROUND FOR TELEVISION

LEARN TROUBLE SHOOTING . . . THEORY . . . WIRING . . . CODE!

WHAT THE NEW IMPROVED 1952 PROGRESSIVE RADIO "EDU-KIT" OFFERS YOU

The Progressive Radio "Edu-Kit" offers you a home study course at a rock bottom price. Our kit is designed to train Radio Technicians, with the basic facts of Radio Theory and Construction Practice expressed simply and clearly. You will gain a knowledge of basic Radio Principles involved in Radio Reception, Radio Transmission and Audio Amplification. You will learn how to identify Radio Symbols and Diagrams; how to build radios, using regular radio circuit schematics; how to mount various radio parts; how to wire and solder in a professional manner. You will learn how to operate Receivers, Transmitters, and Audio Amplifiers. You will learn how to service and trouble-shoot radios. In brief, you will receive a basic education in Radio exactly like the kind you would expect to receive in a Radio Course costing several hundreds of dollars.

THE KIT FOR EVERYONE

The Progressive Radio "Edu-Kit" was specifically prepared for any person who has a desire to learn Radio. The Kit has been used successfully by young and old in all parts of the world. It is not necessary that you have even the slightest background in science or radio.

The Progressive Radio "Edu-Kit" is used by many Radio Schools and Clubs in this country and abroad. It is used by the Veterans Administration for Vocational Guidance and Training.

The Progressive Radio "Edu-Kit" requires no Instructor. All instructions are included. All parts are individually boxed, and identified by name, photograph and diagram. Every step involved in building these sets is carefully explained. You cannot make a mistake.

THE PROGRESSIVE RADIO "EDU-KIT" IS COMPLETE

You will receive every part necessary to build 15 different radio sets. This includes tubes, tube sockets, variable condensers, electrolytic condensers, mica condensers, paper condensers, resistors, tie strips, coils, tubing, hardware, etc. Every part that you need is included. In addition these parts are individually packaged, so that you can easily identify every item.

TROUBLE-SHOOTING LESSONS

Trouble-shooting and servicing lessons are included. You will be taught to recognize and repair troubles. While you are learning in this practical way, you will be able to do many a repair job for your neighbors and friends, and charge fees which will far exceed the cost of the Kit. Here is an opportunity for you to learn radio and have others pay for it. You build a professional Signal Tracer which alone, is worth more than the price of the complete Kit.

THE PROGRESSIVE TEACHING METHOD

The Progressive Radio "Edu-Kit" comes complete with instructions. These instructions are arranged in a clear, simple and progressive manner. The theory of Radio Transmission, Radio Reception, Audio Amplification and Servicing by Signal Tracing is clearly explained. Every part is identified by photograph and diagram; you will learn the function and theory of every part used.

The Progressive Radio "Edu-Kit" uses the principle of "Learn By Doing." Therefore you will build radios to illustrate the principles which you learn. These radios are designed in a modern manner, according to the best principles of present-day educational practice. You begin by building a simple radio. The next set that you build is slightly more advanced. Gradually, in a progressive manner, you will find yourself constructing still more advanced radio sets, and doing work like a professional Radio Technician. Altogether you will build fifteen radios, including Receivers, Amplifiers, Transmitters, Code Oscillator & Signal Tracer.

THE PUBLIC APPROVES!

COMMENTS FROM SATISFIED USERS OF THE PROGRESSIVE RADIO "EDU-KIT"

VETERANS ADMINISTRATION,
PHYSICAL MEDICINE REHABILITATION SERVICE,
WASHINGTON, D. C.

"This morning I was showing the Progressive Radio 'Edu-Kit' to one of our representatives from our Branch Office in Richmond, and already he wants me to purchase some for his hospital. . . . As indicated in previous correspondence, I took the Progressive Radio 'Edu-Kit' to our Veterans Administration Hospital at Fort Thomas, Kentucky. Both instructors and patients worked them, and they proved quite satisfactory."
ROBERT L. SHUFF,

1534 Monroe Ave., Huntington, W. Va.

"Thought I would drop you a few lines to say that I have bought a Progressive Radio 'Edu-Kit' and was really amazed that such a bargain can be had at such a low price. I have already started repairing radios and radio-phonographs. Friends were really surprised to see me get into the swing of it so quickly. The trouble-shooting tester that came with the kit is really swell, and finds the trouble if there is any to be found. Everything you say about your kit is true."
DOMINICK STRACUZZA,

111 Clarence St., London, Ontario

"I am very satisfied with the Progressive Radio 'Edu-Kit' which I bought from you. I did not know anything about radio, but now I feel as though I have been in the radio business for years. Your kit is simple and educational. I enjoy working with it."

Order your Progressive Radio "EDU-KIT" Today, or send for further information.

Postage prepaid on cash orders—C.O.D. orders accepted in U. S. A.

BECOME A RADIO AMATEUR



GET A WELL-PAYING JOB

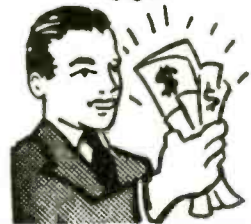

GO INTO A PROFITABLE BUSINESS



PROGRESSIVE ELECTRONICS CO.

497 UNION AVE., DEPT. RE-56

BROOKLYN 11, N. Y.

TEK-FILE



THE ONLY SOURCE For *Exact* SERVICING DATA

Make your servicing job faster — easier — and more profitable by using the new Tek-File: The only monthly service that gives you complete, factory-authorized data which exactly matches the set you're working on.

You buy only what you need — when you need it. Each Tek-File pack has at least 128, 8½ x 11" pages bound in one or more file folders — containing *complete* servicing data for the manufacturer's sets you specify. Easy to file, easy to use in shop or field.

THE MAN WHO USES
RIDER TEK-FILE — MANUALS
MAKES MORE MONEY.

See your jobber today.



JOHN F. RIDER

PUBLISHER, INC.
480 Canal St., N. Y. 13, N. Y.

ume is provided by the 50,000-ohm potentiometer in the screen supply lead.

The slug tuners vary and it may be necessary to try different sizes of capacitors across them till the broadcast band is covered satisfactorily. With the tuners used in this set, a 100- μ f padder was connected in series with the antenna tuning coil, and a 50- μ f trimmer across the combination. A 50- μ f trimmer across the plate coil was found satisfactory.

The slug tuners were picked up at surplus supply stores. If suitable types are not at hand, coil-capacitor combinations will work at least as well. While coil-capacitor tuning gave good results on breadboard tests, slug tuners were adopted for the final model on account of the greater compactness.

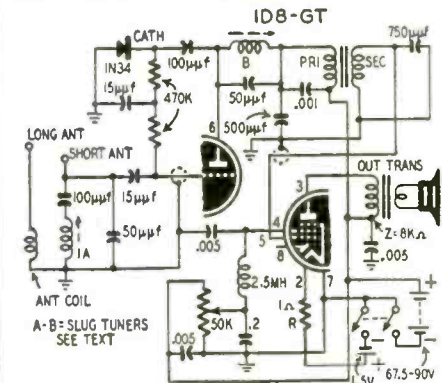

Fig. 1—The 1D8-GT circuit proved best.

Several speakers and types of output were tried. Best was a sensitive 4-inch PM speaker with a voice-coil impedance in the order of 3 or 4 ohms. The output transformer primary impedance was high—8,000 ohms.

Layout and design

It is desirable not to crowd parts. The two slug tuners were kept as far apart as possible. Size of the bakelite panel is 5¼ x 7 inches. The 1N34 was mounted in two spring binding posts, making it easy to try different units and unnecessary to solder it. This is useful, as soldering can destroy the crystal's sensitivity. Various crystals should be tried, as some produce much greater volume than others. The one finally chosen in this set was of the latest glass-enclosed type.

The layout is rather critical, and should be followed exactly, as shown in the photographs. If the experimenter desires a different type of layout, he will be well advised to get the set working on a breadboard first, as the set

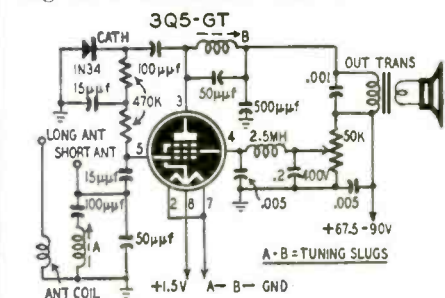

Fig. 2—Hookup which used a 3Q5-GT.
RADIO-ELECTRONICS for



Into your home, through the miracle of television, comes a new world of entertainment, news, education, and sports.

They can still go out while staying home

Now "homebodies" who seldom leave their neighborhoods can view programs from distant cities—with all the comforts of home. Drama, comedy and variety shows are brought into the living room. Sports, news events as they happen can be viewed by all. Now television is open coast to coast . . . Those in the East may look in on the West, and the West may look in on the East.

Television is enjoyed in more than

15 million homes, as a result of research at the David Sarnoff Research Center of RCA at Princeton, N. J. Today's image orthicon TV camera was perfected there. Dr. V. K. Zworykin of RCA developed the *kinescope*—which is the screen of television receivers. And RCA scientists have also perfected electron tubes, circuits, sound systems, phosphors, and antennas to make television part of everyday life.

The development of all-electronic television is only one example of RCA research. This leadership assures you high quality performance from any product or service of RCA and RCA Victor.

See the latest wonders of radio, television, and electronics at RCA Exhibition Hall, 36 West 49th St., New York. Admission is free. Radio Corporation of America, Radio City, New York 20, New York.



RADIO CORPORATION of AMERICA

World Leader in Radio — First in Television



PERFECTION ION TRAPS

- Simplest to Install
- No Wobble

Now Standard Equipment
on All Leading TV Sets

Write Today for Prices!

PERFECTION ELECTRIC COMPANY

2637 SOUTH WABASH AVENUE, CHICAGO 16, ILLINOIS



PEN-OSCIL-LITE

Extremely convenient test oscillator for all radio servicing; alignment • Small as a pen • Self powered • Range from 700 cycles audio to over 600 megacycles u.h.f. • Output from zero to 125 v. • Low in cost • Used by Signal Corps • Write for information.

GENERAL TEST EQUIPMENT
38 Argyle Ave. Buffalo 9, N. Y.

PARTS—TUBES—KITS

50L6—68; 35Z5—50; 6SN7—88; 5V4G—99; 6J6—\$1.06. Standard Brand—Fully Guaranteed. Stanczyk TV Coil Kit—List \$12.95—Special \$3.95. 20" TV Kit \$65.00 Less Tubes. Write for free catalogue. Minimum order \$5.00 F.O.B. N. Y. Money-back guarantee. Send 20% with order.

CERTIFIED TELEVISION LABORATORIES
Dept. C, 5507-13th Ave., Brooklyn 19, N. Y.

may not work well if parts are too crowded.

The cabinet is unique. It is divided into halves, one of which holds the speaker and batteries, the other the receiver proper. When in use, the rear

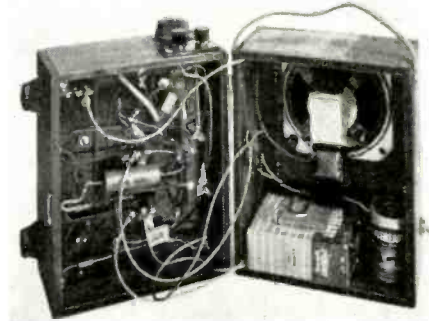

A view of the "inside" of the receiver.

half-cabinet is swung around so the speaker faces the operator. The cabinet was made of 1/2-inch plywood, though lighter wood might have been used. It is planned to cover the front with a piece of plastic. The tuning scale, made of Bristol board, will then be visible, but the parts will be protected from damage. Ganging the two tuners would be too complex a problem to be practical.

Different antennas were tested. A 50-foot antenna worked well connected to an antenna coil of 15 turns at the ground end of the antenna coil. A 3 1/2-foot telescopic type connected to the SHORT ANT post was also used with excellent results. A ground connection should also be used, as it increases stability as well as sensitivity. The set was tried in New York City and at a point 25 miles away.

A 3Q5 circuit

Other tubes—including a double triode—were tried in the same general type of circuit, but the only one that gave any worthwhile results was the 3Q5-GT, whose circuit is shown in Fig.

Largest Selling Booster

AT ANY PRICE !



Regency



to tell the truth

there is no finer magazine in
the field than

RADIO - ELECTRONICS

Gives full technical coverage on

RADIO • TELEVISION • AUDIO

**Servicing • Installation • Construction • Operation
Theory • New Developments • Circuits**

It's no lie . . .

You save money (up to eight cents a copy over the newsstand price) and you assure yourself of getting your copy of RADIO-ELECTRONICS every month when you subscribe at these

LOW SUBSCRIPTION RATES

Three Years \$8.00

Two Years \$6.00

One Year \$3.50

*Check this list of features
scheduled for publication
in coming issues.*

- ✓ Servicing TV Control Circuits
- ✓ TV Antennas Simplified
- ✓ Maintaining Two-way Radios
- ✓ Multi-range Milliammeter
- ✓ Using Variable Line Voltage in Servicing
- ✓ New Recording and Reproducing System
- ✓ Tuning the Audio System
- ✓ Practical Multi-tester

25 West Broadway

New York 7, N. Y.

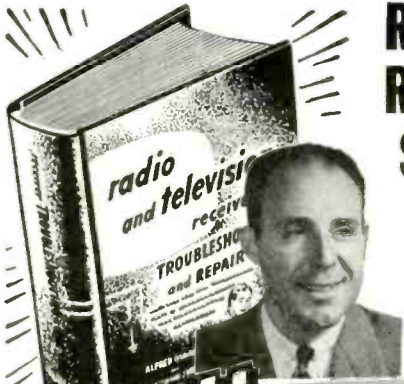

RADIO and TELEVISION RECEIVER TROUBLESHOOTING and REPAIR

by A. A. Ghirardi and J. R. Johnson
820 pages, 417 illustrations, 6x9, price \$6.75

The complete know-how of service procedure by the most modern time-saving professional methods

NOW! GHIRARDI'S Complete New Service Training Course

Helps you lick the toughest service problems!
Paves your way to the big-money jobs!

22 COURSES IN ONE!

Here is what this big book covers:

- 1—Receiver Components and Their Troubles; 2—How to Develop a Systematic Troubleshooting Procedure; 3—Basic Methods: Preliminary Questions and Checks; 4—Static Tests; 5—Dynamic Testing; 6—Practical Direct-Approach Troubleshooting; 7—Special Problems in AC/DC and 3-Way Portables; 8—Special Battery Set Problems; 9—Servicing Communications Receivers; 10—Troubleshooting Television Receivers; 11—Taking Performance Data; 12—Re-aligning AM Receivers; 13—Re-aligning FM; 14—Re-aligning TV; 15—Replacing Defective Resistors; 16—Replacement and Repair of R-F and I-F Inductors and Transformers; 17—Power, A-F and Deflection—Frequency Inductors and Transformers; 18—Defective Capacitors; 19—Servicing Tuning-Drive Mechanisms, Station-Selector and Band Switches; 20—Testing, Replacing and Repairing Loudspeakers; 21—Servicing Record-Playing Equipment; 22—Servicing Home Recorders.



MONEY-SAVING COMBINATION

Make your service library complete—save money in the bargain. Get the above great new Ghirardi book PLUS the new Ghirardi RADIO AND TELEVISION RECEIVER CIRCUITRY AND OPERATION (issued only a few months ago) at the special price of only \$12.00 for the two. (Regular price for the two books is \$12.75.)

Ghirardi's RECEIVER CIRCUITRY & OPERATION brings you complete, easy training on the basic circuits and operating principles of all radios, TV sets, record players, etc. Makes you far less dependent on service manuals, mfrs' data—helps you go right to the seat of troubles in 1/2 the usual time! SEE COMBINATION OFFER IN COUPON!

BRAND NEW... Just off the Press!

Here's the big book you've been waiting for... the new Ghirardi guide to modern Radio-TV servicing by professional methods... a book that can help give your earning power a big boost by teaching you to work faster, more efficiently on every receiver service job!

RADIO AND TV RECEIVER TROUBLESHOOTING AND REPAIR starts with a full analysis of radio-TV components and why they fail. Next you learn how to work by the most modern service methods—from quick analyses to static tests of electrical characteristics to dynamic signal tracing and signal injection. Special problems in ac/dc, battery sets and others are clearly explained. A big TV service section is arranged so that you can find answers to specific problems in a jiffy. Complete chapters greatly simplify alignment procedure for each type of receiver. Six chapters cover every phase of component replacement, testing, tuning problems, speaker troubles, etc. Over 400 illustrations make things doubly easy to understand—including dozens of unique step-by-step charts that explain complicated details of the work almost at a glance.

Nowhere else will you find servicing explained so clearly or in such handy form for either study or on-the-job reference. Read this great book for 10 full days of our risk. MAIL COUPON TODAY!

FLASH! SHOULD SERVICEMEN BE LICENSED?

No matter how any of us may feel about it, the fact remains that many cities and states are now preparing laws requiring servicemen to undergo rigid licensing tests. Let these two Ghirardi books help prepare you today for any such test you might have to pass!

10-DAY EXAMINATION

Dept. RE-22 Rinehart Books, Inc., Technical Division, 232 Madison Ave., New York 16, N. Y.

Send the new Ghirardi RADIO & TELEVISION RECEIVER TROUBLESHOOTING & REPAIR for 10-day examination. If I like book, I will then promptly send \$6.75 in full payment. If not, I will return book postpaid in good condition and owe you nothing.

RADIO-TV SERVICE COMMUNICATION OFFER—Send above book PLUS RADIO & TV RECEIVER CIRCUITRY AND OPERATION on same examination basis. Special price for both books only \$12.00 (To be paid in 10 days, or books returned.)

Name
Address
Employer's name & address
City, Zone, State

2. Incidentally these small battery tubes vary considerably, and if anticipated results are not obtained, you will be well advised to try another tube of the same type. This is particularly true if old tubes are used. It is also worth while to get the set going with a pair of headphones at first.

If you are not used to working with battery tubes, be careful! Check all



Closed, the set becomes a neat portable.

connections, and hook the B-battery in circuit only after you are sure you are right. The 1D8-GT filament requires only 50 ma at 1.4 volts, and is very easy to burn out. A 1-ohm resistor R in the filament circuit reduces the cell's 1.5 volts to 1.4 for the filament. It may be shunted out as the A-cell runs down.

Bill of Materials

- 2 slug (iron core) tuners; to cover broadcast band.
- Capacitors: 2—50, 2—15, 2—100, 1—500, 1—750 μ mf; 1—.001, 3—.005, 1—.02 μ f.
- Resistors: 1—1 ohm, 1/2 watt, 2—470,000 ohms, 1/2 watt; 1—50,000-ohm potentiometer.
- R. f. choke: 1—2 1/2 mh
- 1 Antenna coil (see description in text).
- 1 PM loudspeaker, 4-inch, 3.2 ohms (approximate) impedance.
- Transformers: 1 interstage, 3-1 ratio, with about 10,000-ohm primary impedance. 1—output transformer, 8,000 ohm impedance primary, 3 to 4 ohm impedance secondary.
- Batteries: 1—67 1/2 volt B-battery; 1—1.5-volt flashlight cell; 1—bias battery (if used).
- Miscellaneous: 1—d.p.s.t. battery switch. Binding posts and spring connectors as required; pushback hookup wire; bakelite or similar panel; cabinet, made from 1/4-inch plywood, stained and waxed, with necessary hardware.

—end—

NEW MAGNETIC FOCUS TUBE

Apparently inspired by the wave of developments in low-voltage and automatic-focus electrostatic focusing tubes, a new magnetic focus tube which requires a much smaller focusing magnet than present types has been announced. Its inventors, Edgar W. Morse and C. V. Fogelberg, of the National Video Corporation, Chicago, say that the new tube, by retaining the principle of magnetic focusing, permits sharper focus and better contrast between black and white. They declare further that the new tube can save up to 4,500 tons of copper per year by replacing electromagnetic focus coils, or a considerable quantity of magnetic metal by replacing large Alnico V magnets with smaller ones of Alnico III.

GANGING PLUG-IN COILS

Recently I constructed a receiver which used plug-in coils in the detector and oscillator stages. After the novelty wore off, I found it very disagreeable to have to change two coils every time I changed bands. The obvious solution appeared to be to plug in both coils with one motion.

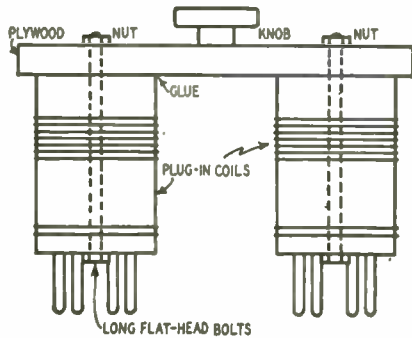

Small receivers like mine without an r.f. stage have very little shielding in the front end; in my receiver the shield between the stages is only as high as the coil. I saw that if I cut about a quarter of an inch from the shield I could couple the two coils together with a piece of wood. I cut a piece of 1/4-inch plywood wide enough to fit across the tops of the coils and bolted it onto the tops of the coils as shown in the drawing.

Use bolts with flat heads at the bottoms of the coils so that the coil will plug all the way into the sockets, and tighten the nuts on top while the coils are sitting in their sockets. After the nuts are tightened and the coils have been plugged and unplugged a few times without strain, put a drop of liquid solder on the nuts at the top and on the bolt heads under the coil. Liquid solder or a strong glue around the rims of the coils where they meet the wood will give added solidarity to the assembly. A knob or handle mounted at the center of this wooden support piece will improve the appearance and ease in handling of the plug-in units. The relatively small diameter bolts in the forms do not significantly affect the tuning range or Q of the coils.—*B. W. Welz*

EMERGENCY VIBRATOR TRANSFORMER

Standard power transformers can be used as vibrator transformers for emergency or experimental work if they have a center-tapped 5- or 6-volt heater

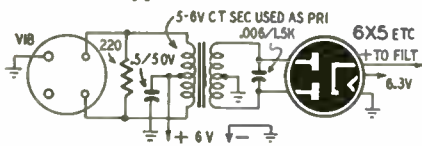

winding. Simply connect the filament winding as you would the primary of a standard vibrator transformer. A typical circuit is shown.—*Fred Ellard*

(The output voltage will be nearer normal and the power losses will be lower if you select a transformer having two high-current 6-volt windings. They need not be center-tapped. Connect the windings in series-aiding and use their junction as the center-tap.—*Editor*)

High-Fidelity • TV • Radio
Phonographs • P.A. • Parts
Test Equipment • Tools • Books
Ham Gear • Electronic Tubes



31st year

New Lafayette Catalog NOW READY!

IMMEDIATE SHIPMENTS
★
COMPLETE STOCKS
★
TECHNICAL SERVICE
★
30-DAY MONEY BACK GUARANTEE
★

A practical encyclopedia used by economy-minded servicemen, hams and technicians throughout the world because they know they have a complete "one-source" guide. For quality equipment, for hard-to-get items, for nationally-advertised merchandise, for low prices, it's Lafayette.

Lafayette RADIO & TELEVISION
DIV. RADIO, WIRE, TELEVISION, INC.

RUSH THIS COUPON AT ONCE

VISIT LAFAYETTE SHOPPING CENTERS at
100 Sixth Ave. New York 13, N. Y.
•
110 Federal St. Boston 10, Mass.
•
24 Central Ave. Newark 2, N. J.
•
542 E. Fordham Rd. Bronx 58, N. Y.

Lafayette Radio, Dept. JB
100 Sixth Avenue
New York 13, N. Y.

I need the 1952 catalog. Please rush!

Name

Address

City Zone.....State

FREE!



PASTE ON POSTCARD

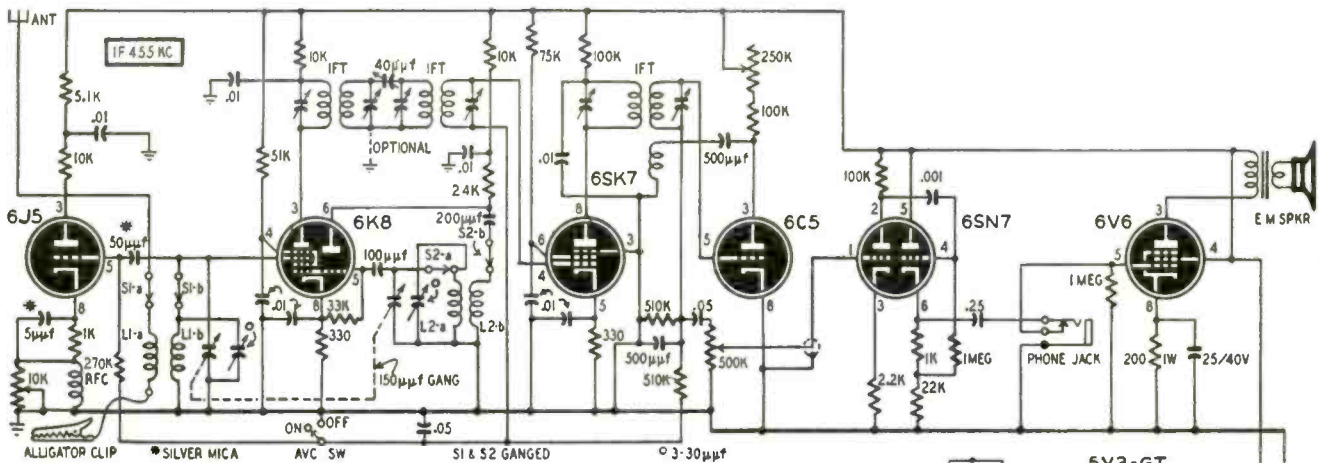
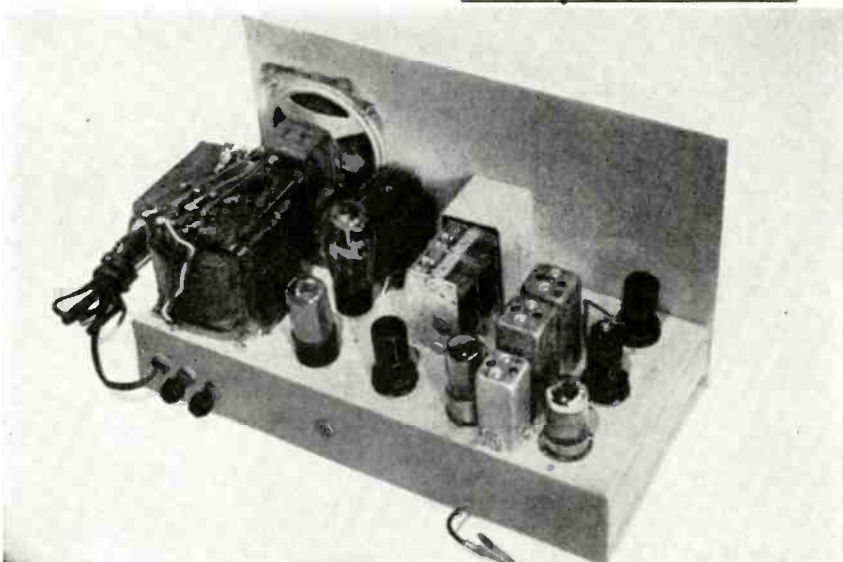

Fig. 2—A low-noise, all-band communications receiver for serious operators.

A COMMUNICATIONS RECEIVER FOR HAMS

By T. W. DRESSER



View of chassis showing position of parts. Power transformer is at left.

IN THE course of a long career as a radio engineer the writer has designed many receivers, both commercially and for his own entertainment. He has yet to be wholly satisfied with any completed job. They fulfilled the purpose for which they were intended and listeners generally let them get by without too many derogatory remarks. Yet to me, as the proud parent of each

new development, there was always some flaw—a little too much noise, perhaps; the volume control could have been placed better, or something like that.

To a great extent this feeling arises from the natural enthusiasm with which a designer approaches every new job. This will always be the best ever of its type! When it is finished, however, there is almost always some point which he feels he could have improved upon (given a little more time). So he stores the item in his memory and in the next receiver duly allows for it, only to find on completion that there is something else at which he gibes. And so it goes; seeking the superlative and never finding it.

A good many years ago we commenced work on such a receiver. It was to be the communication job *par excellence*, with 14 tubes, each pulling its

full weight, silver-plated coils, turret switching, double frequency conversion, and everything! Before it could be completed however, the war intervened; the half-built chassis was flung into a cupboard and forgotten when the writer left for other parts on a quite different assignment.

Recently it came to light again during an orgy of junk clearing. It still looked pretty good and we decided to finish the job, making due allowance for the big improvements in tubes, components, and circuitry since that time.

To begin with, no communication receiver can improve greatly on the sensitivity and general excellence of the better types now on the market. If we can achieve results as good with simpler apparatus, if we can assure greater flexibility of control with fewer controls, or improve the quality of output on speech without sacrificing anything else,

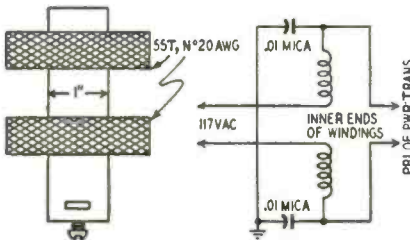
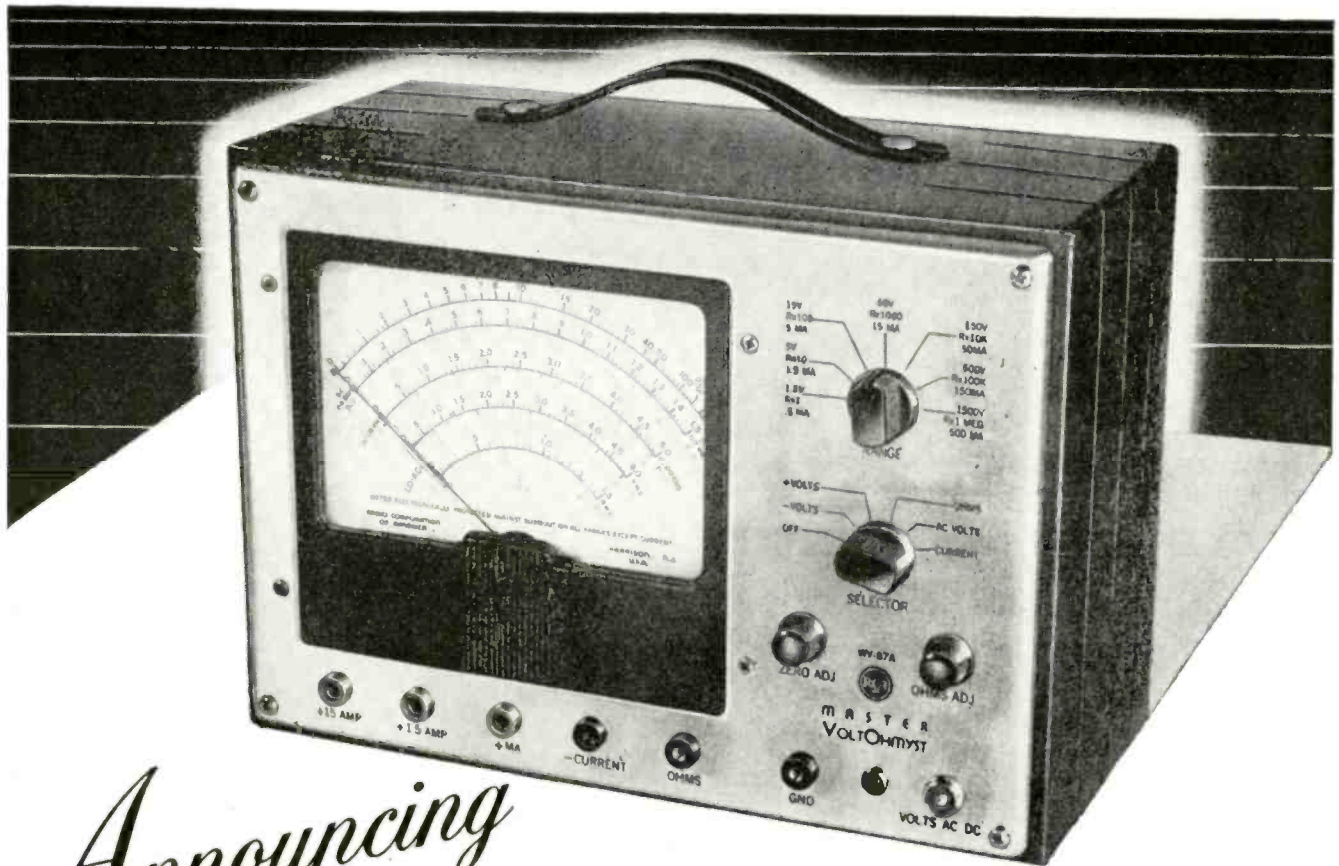

Fig. 1—Construction of the line filter.



Announcing

The new RCA WV-87A *Master* VoltOhmyst*

\$112.50 Suggested
User Price

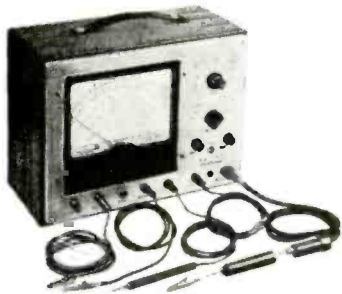

Measures... (Full-scale ranges)

DC VOLTAGE: 0 to 1.5, 5, 15, 50, 150, 500, 1500 volts

PEAK-TO-PEAK VOLTAGE: 0 to 4, 14, 42, 140, 420, 1400, 4200 volts

RMS VOLTAGE: 0 to 1.5, 5, 15, 50, 150, 500, 1500 volts

RESISTANCE: 0 to 1000 megohms in seven overlapping ranges

DC CURRENT: 0 to 0.5, 1.5, 5, 15, 50, 150, 500 milliamperes; 0 to 1.5, 15 amperes

Sold Complete — with the following Probes and Cables

- Direct Probe and Cable
- DC Probe
- Ohms Cable and Probe
- + Current Cable (Red)
- - Current Cable (Black)
- Ground (Case) Cable

Accessory Probes Available on Separate Order

- ✓ WG-264 Crystal-Diode Probe for measuring ac voltages at frequencies up to 250 Mc.
- ✓ WG-289 High-Voltage Probe, with WG-206 Multiplier Resistor, for increasing dc-voltage range to 50,000 volts and input resistance to 1100 megohms.

FEATURING an 8½" meter, the new WV-87A Master VoltOhmyst is really the master of every testing application. Its peak-to-peak scales are particularly useful for television, radar, and other types of pulse work.

The WV-87A measures dc voltages accurately in high-impedance circuits, even with ac present. It also reads rms values of sine waves and the peak-to-peak values of complex waves or recurrent pulses, even in the presence of dc.

Like all RCA VoltOhmysts, the WV-87A features ±1% multiplier and shunt resistors, a ±2% meter movement, high-input resistance, zero-center scale adjustment for discriminator alignment, dc polarity-reversing switch, and a sturdy metal case for good rf shielding.

On direct-current measurements, extremely low-

meter resistance gives an average voltage drop of only 0.3 volt for full-scale readings on all ranges. Nine overlapping ranges provide dc readings from 10 microamperes to 15 amperes.

An outstanding feature is its usefulness as a television signal tracer... made possible by its high ac input resistance, wide frequency range, and direct reading of peak-to-peak voltages.

The RCA WV-87A Master VoltOhmyst has the accuracy and stability for laboratory work. Its large, easy-to-read meter also makes it especially desirable as a permanently mounted instrument in the factory and repair shop.

For complete information on the WV-87A, see your RCA Test Equipment Distributor or write RCA, Commercial Engineering, Section BX49, Harrison, New Jersey.

*Reg. U. S. Pat. Off.

Get complete details today from your RCA Test Equipment Distributor.



RADIO CORPORATION of AMERICA

TEST EQUIPMENT

HARRISON, N. J.

NEW a "must" book
for every
TV Service Technician

**"Servicing TV
in the
Customer's Home"**



**SAVES TIME
SAVES WORK
Earns More
for You
on Outside
Service Calls**

shows how
to diagnose trouble using
capacitor probe and VTVM

Here's the book you've been asking for—practical, proved help to make your outside TV servicing really effective and profitable. Saves time, work and chassis hauling . . . shows you how to make successful repairs on the spot. You learn the following: 1. A simple, effective method for tracing down trouble, using your VTVM and a simple capacitor probe. 2. Methods for finding your way around a strange circuit—shows you how to "pull tubes" and diagnose trouble by observing audio and picture effects. 3. How to judge TV set performance by analysis of the test pattern. 4. Methods for making adjustments in the field. You'll want this essential, profit-building book. Handy pocket size; sturdy cover. **\$1.50**

ORDER TC-1. Only
Pays for itself on the very first job.

HOWARD W. SAMS & CO., INC.

Order from your Parts
Jobber, or write direct to
HOWARD W. SAMS & CO.,
2201 E. 46th St., Indianapolis 5, Ind.

Send . . . copy(ies) of "SERVICING TV IN THE
CUSTOMER'S HOME," \$1.50 per copy.

(Check) (money order) for \$ enclosed

Name

Address

City State

**ORDER
TODAY**

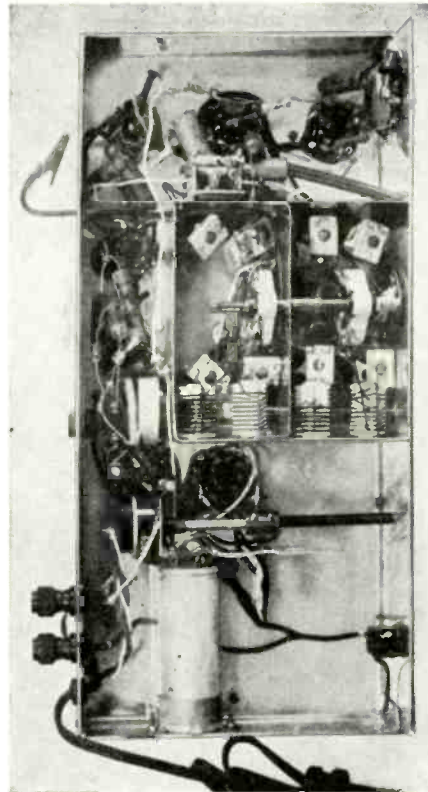

Under-chassis view. Note the layout of coils and the use of interstage shield.

we have done a good job.

In the design of any high-gain, high-frequency receiver a number of factors are involved, frequently interrelated, which are not apparent to the layman or even to many service engineers.

The noise problem

First, there is the big question of noise. The shielding of a communications receiver is generally so thorough that outside r.f. noise need not be considered. If it is present at all a noise-limiter circuit will dispose of it. Equally, with noise carried in by the a.c. line. A good line filter at the power input will clear this up. A circuit diagram for such a filter is given in Fig. 1.

Inherent noise, however, is a totally different matter. By judicious designing it may be reduced but it cannot be entirely eliminated. Thermal agitation noise, as it is more generally called, is due to the movement of electrons in the various components and produces a very wide range of frequencies at minute voltages. It is audible in the output as a persistent hiss, and the limit to useful amplification in any receiver is reached when the thermal agitation noise in the first tuned circuit, when terminated in an impedance equal to that of the antenna, fully drives the output stage with the receiver in its most selective condition. The voltages due to the thermal agitation noise are proportional to the square root of the tuned impedance of the circuit and the square root of the bandwidth. When fed directly into a mixer-oscillator the noise at its output is effectively greater since some of the noise frequencies combine with oscil-

Model 200
**AM & FM SIGNAL
GENERATOR**

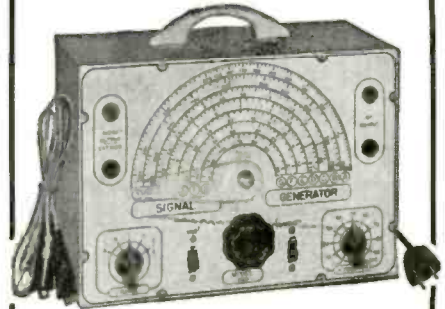

Specifications: • R. F. FREQUENCY RANGES: 100 Kilocycles to 150 Megacycles. • MODULATING FREQUENCY: 400 Cycles. May be used for modulating the R.F. signal. Also available separately. • ATTENUATION: The constant impedance attenuator is isolated from the oscillating circuit by the buffer tube. Output impedance of this model is only 100 ohms. This low impedance reduces losses in the output cable. • OSCILLATORY CIRCUIT: Hartley oscillator with cathode follower buffer tube. Frequency stability is assured by modulating the buffer tube. • ACCURACY: Use of high-Q permeability tuned coils adjusted against 1/10th of 1% standards assures an accuracy of 1% on all ranges from 100 Kilocycles to 10 Megacycles and an accuracy of 2% on the higher frequencies. • The Model 200 operates on 110 Volts A.C. Comes complete with output cable and operating instructions.

\$21.85
NET

Sold on Money-Back-If-Not-Satisfied Guarantee.

We carry a complete line of test equipment and components. Write for FREE Catalog
GENERAL ELECTRONIC DISTRIBUTING CO.
Dept. RE-2, 98 Park Place, New York 7, N. Y.

SAVE \$50
DUAL TRACK TYPE
TAPE RECORDER

Made For Us By America's Best
Known Recorder Manufacturer!

LIFE-LIKE
Reproduction!

COMPARE WITH
MODELS SELLING
FOR \$179.50

\$119.50



FEATURES: Amazing new push-button speed change provides 2 FULL HOURS recording on 7" reel at 3 3/4" per sec. Or one full hour recording on 7" reel at 7 1/2" per sec. Fast forward and rewind speeds. Editing key allows you to delete or add to while playing. Magic eye recording indicator. Positive interlock control switch. Crystal microphone. Power output, 5 watts to speaker. Line voltage: 105/120 volts, 60 cycles. Order now at this special factory price.

FREE! Write for
Yours Now!
Latest FYI BULLETIN
Filled with latest values, and
information on new equipment!

WHOLESALE
RADIO PARTS CO., Inc.
311 W. Baltimore St.
BALTIMORE 1, MD.

lator harmonics and image frequencies to produce noise voltages within the i.f. band.

Another source of noise is the tubes. All tubes produce noise to some extent, varying in amount with their structure and characteristics and the materials of which the electrodes are made. The noise generated in a tube is due to the random arrival of electrons at the plate. The "shot" noise produced in triodes and diodes is proportional to the plate current divided by the square of the mutual conductance. It follows that if the mutual conductance is high for a given plate current the noise must be relatively low.

With multigrid tubes the matter is more complex. The space current is then divided between the plate and the grids and the noise voltage as calculated on a plate-current basis must be multiplied by a factor greater than one. To obtain the minimum noise voltage in a multigrid tube the screen current should be small compared with the plate current, and the mutual conductance (or conversion conductance in the case of a mixer-oscillator), large. In other words, the best signal-to-noise ratio is obtained in the tube in which the mutual conductance is highest for the lowest plate current.

Now let us consider mixer oscillators in relation to these facts. The 6K8 characteristics show a plate current of 2.5 ma and a screen current of 6 ma with plate volts 250 and screen volts 100. At these figures the conversion transconductance is 350 μ mhos. For the 6A8 and 6A7 the figures are: plate volts 250, plate current 3.5 ma, screen volts 100, screen current 2.7 ma, conversion transconductance 550 μ mhos.

Now take a similar r.f. pentode, the 6K7. With plate and screen volts as on the mixer-oscillator, plate current is now 7 ma and screen current only 1.7 ma, while the mutual conductance has risen to 1,450 μ mhos! The 6AC7, which is a low-noise tube, has even better figures, the mutual conductance being 9,000 μ mhos with plate current 10 ma at 300 volts and screen current 2.5 ma at 150 volts. A simple comparison of these figures shows that the ratio of conversion transconductance to plate current in a mixer-oscillator is considerably worse than the ratio of mutual conductance to plate current in a standard r.f. pentode, and the noise is worse in the same ratio.

For the same signal-to-noise ratio that could be obtained from an r.f. pentode the signal applied to the grid of a mixer-oscillator would have to be greater by an amount roughly equal to the ratio of their transconductances. The means by which the additional gain is secured must be reasonably free from noise in order to maintain the original signal-to-noise ratio. In actual practice the use of a mixer-oscillator in a high-gain receiver compels the use of at least one r.f. preamplifier to insure reasonable signal-to-noise ratio; if the coverage extends to 30 mc or higher it is preferable to use two r.f. stages to maintain a satisfactory signal-to-noise ratio.

**MORE TV
OUTLETS
PER
DOLLAR!**

AMPLIFIED, ALL-CHANNEL MASTER ANTENNA SYSTEMS

FOR 2 TO 2000 TV SETS

NO Special connectors
NO Matching transformers
NO Engineers
NO Individual channel equipment

BLONDER-TONGUE systems are based on the use of "no loss" Distribution Amplifiers which split the signal from the antenna into the desired number of outlets... all having the same signal level and picture quality as though each TV set used the antenna alone.

The B-T Automatic, All-Channel systems, using three basic units in any desired number and combination, can be easily installed by any TV service man.

**INSTALLED WITH THE
TURN OF
A SCREW**

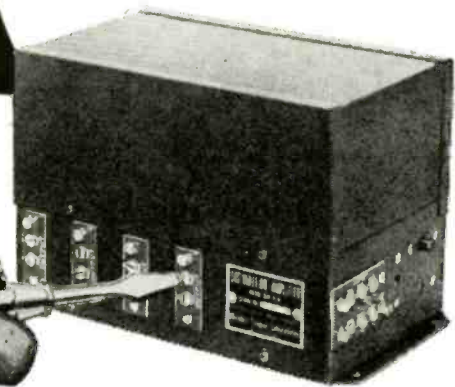
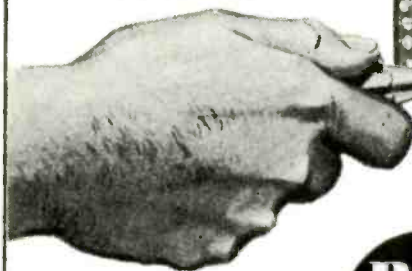

DISTRIBUTION AMPLIFIER, MODEL DA8-1-M
8 TV Outlets
Amplified and Isolated
List Price \$87.50

Combine these B-T units to serve up to 2,000 sets from 1 antenna.



B-T HOME ANTENSIFIER MODEL HA-2-M



Model #CA-1-M
Commercial Antensifier
(30 Times Gain)
Use As Pre-Amplifier, Line Amplifier or de-luxe Booster
List Price \$77.50



MODEL #DA2-1-M
Distribution Amplifier
2 TV Set Outlets
List Price \$39.50



Finest All-Channel TV Booster. Fully Automatic, 16 Times Gain. In Metal Cabinet
List Price \$57.50

FREE INSTRUCTION BROCHURE ON MASTER ANTENNA SYSTEMS.. Write Today. Dept. D2

Blonder-Tongue Labs., Inc. Mt. Vernon, N. Y.

Over 43,000 Technicians Have Learned
**HOW TO GET THE MOST OUT
OF BASIC TEST EQUIPMENT**
Why Not You, Too?

SERVICING by SIGNAL SUBSTITUTION
A BEST SELLER FOR OVER 9 YEARS! (NEW, UP-TO-DATE, 12TH EDITION)

The Simple, Modern, Dynamic Speed Approach To Receiver Adjustment and Alignment Problems, AM-FM-TV.

- Nothing complex to learn
- No extra equipment to purchase
- Universal - non-obsolete
- Employs Only Basic Test Equipment

Ask for "S.S.S." at your local Radio Parts Jobber or order direct from factory.

PRECISION APPARATUS COMPANY, INC. • 92-27 Horace Harding Blvd., Elmhurst 4, N. Y.



only 40¢

100 pages. Invaluable information that will help you re-double the value of your basic test equipment.

For Direct Drive Circuits... New STANCOR

TELEVISION REPLACEMENT COMPONENTS

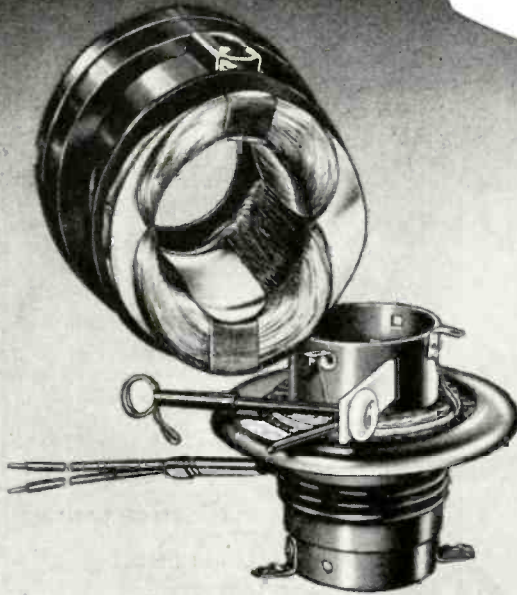

**DY-10
ANTI-ASTIGMATIC DEFLECTION YOKE**
A high efficiency yoke with cosine distributed windings, ferrite core and nylon bobbins. Replacement in 34 RCA TV models, 30 Emerson models and 7 Capehart models.
A-8131 AIR CORE "FLYBACK"
Companion unit to DY-10 in direct drive circuits and used in same models. See Stancor Bulletin No. 389 for a complete list of these 71 models.

A-8140 VERTICAL OUTPUT TRANSFORMER
Has primary:secondary ratio of 44:1. Replaces RCA No. 74950 in 35 TV models, Emerson No. 738044 in 30 models and Capehart No. 650238A-1 in 7 models. These models are listed in Stancor Bulletin No. 390. Ask your distributor for a free copy.

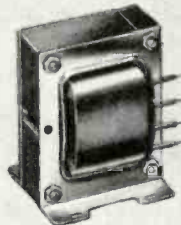

Stancor transformers are listed in Howard Sams' Photofacts Folders

STANDARD TRANSFORMER CORPORATION

3592 ELSTON AVENUE • CHICAGO 18, ILLINOIS

HAVE YOU A JOB FOR A TRAINED TECHNICIAN?

We have a number of alert young men who have completed intensive training in Radio and Television Repairing. They learned their trades thoroughly by working on actual equipment under personal, expert supervision. If you need a trained man, we invite you to write for an outline of our course, and for a prospectus of the graduate. No fees, of course. Address:

Placement Manager, Dept. P108-2

COMMERCIAL TRADES INSTITUTE

1400 Greenleaf

Chicago 26



COLOR TONE! ON YOUR TELEVISION!

Simply attach TELECOLOR FILTER to front of set and enjoy programs in glorious color tones instead of dull black and white. **GUARANTEED** to give genuine color tone. Can also be used with any other filter. Once tried, you will never go back to old black and white. Write for **FREE** information. **ORDER BY MAIL. NEW REDUCED PRICES!** Send check, M.O., cash, COD to Dept. RE-4

10 in.	\$1	16, 17 in.	\$3
12, 14 in. \$2		19, 21 in.	\$5

HARVARD LAB. 659 FULTON ST.
BROOKLYN, N.Y.

An original method

It is precisely for these reasons that most manufacturers employ separate oscillators in their communications receivers. We could therefore use the conventional setup of one or two r.f. stages, with an r.f. pentode as mixer and a separate oscillator. Such a combination is capable of outstanding results; but it is a complicated arrangement for the home constructor to build without encountering trouble with stability and alignment. An alternative arrangement and one which the writer prefers, although the commercial manufacturers do not favor it, is that of a normal mixer-oscillator with regeneration in a separate low-noise tube. The sensitivity and selectivity of this arrangement is more than that secured from a single r.f. stage and mixer-oscillator, and the noise level definitely lower. In addition—and this factor counts heavily with most amateurs—the cost is considerably less, as the use of a regenerative stage in place of an r.f. stage means fewer coils, a smaller gang capacitor, and fewer switching complications. The circuit is used in the receiver of Fig. 2.

Regeneration is supplied by a 6J5 with a choke coil in its cathode circuit. The coil (RFC in the diagram) can be any good shortwave choke or about 130 turns of No. 30 AWG enamel wound on a ¼-inch form. It is bypassed with a 10,000-ohm potentiometer. Increasing the resistance across RFC increases regeneration.

An interesting feature of the circuit is that, as the apparent resistance of coil L1-b is decreased by the regeneration, its apparent Q to the input of the mixer tube also goes up (approximately to infinity as oscillation—and consequently negative resistance—is approached). Thus we obtain a very-high-gain input circuit to our mixer.

Using the first arrangement with two r.f. amplifiers, any received signal fully loads the output stage, and the limiting factor on the noise and the signal-to-noise ratio then becomes that set by the a.v.c. If the a.v.c. is given a delay voltage slightly greater than that of the noise at the diode rectifier, the only signals lost are those at or slightly above the noise level. Even then, the r.f. and final i.f. stages are liable to overload on a powerful signal unless the a.v.c. is amplified. On the other hand, with the regenerative stage, control resolves itself into the simple business of backing off the regenerating tube. This can be done by applying a.v.c. to the grid of the tube, and if it is also applied to the i.f. stage, control will be adequate for all but very exceptional signals.

The intermediate frequency

It is the fashion nowadays to have an intermediate frequency in the megacycle range. While there are advantages to be gained thereby, notably in avoiding image interference, a high i.f. makes tracking of the input and oscillator circuits rather more difficult than with a lower frequency. Moreover, high intermediate frequencies do not give

the same selectivity as circuits operating on 455 kc. An i.f. of 455 kc has therefore been chosen for this receiver, to simplify tracking and improve selectivity.

The i.f. stage is perfectly normal and uses standard air-core transformers. To give variable selectivity the mixer is coupled to the i.f. tube through two transformers placed back-to-back and coupled by a 40- μ f variable capacitor. This is, of course, the well known high-impedance "top coupling" circuit. (Use the best high-gain i.f. transformers, or you will have a good attenuating circuit!—Editor).

COIL TABLE

Band meters	L1-a		L1-b		Spacing inches
	Turns	Wire	Turns	Wire	
160	11	24	72	22	3/16
80	5 1/2	22	46	20	3/16
40	4 1/2	18	19	18	3/16
20	3 1/2	16	9	16	1/4
10	1 1/2	16	4	16	1/8

Band meters	L2-a		L2-b		Spacing inches
	Turns	Wire	Turns	Wire	
160	12 1/2	20	40	22	3/16
80	5 1/2	20	18	18	3/16
40	4	18	8 1/2	18	3/16
20	2 1/2	16	4	16	1/8
10	1 1/2	16	2	16	1/16

All wire sizes AWG; all wire enameled. Coils close-wound on 3/4-inch-diameter ceramic forms 1 1/2 inches long. "Spacing" means spacing between coils.

The transformer coupling the i.f. tube to the second detector requires some special mention in view of its rather unusual nature. It was intended originally to use a double-diode-triode with some form of regeneration, but it was felt that—apart from the complexity of the arrangement—the old bogey of a.c. load impedance to d.c. load resistance had to be reckoned with. Finally the circuit shown in Fig. 2 was evolved. This has the advantage of giving very smooth regeneration with good control of sensitivity and selectivity and without the complication of another tube. To obtain this regeneration it was necessary to doctor the transformer. An ordinary 455-kc transformer was made adjustable by loosening the lower winding. This was then slid down the form until optimum coupling was located—about 1 1/4 inches. The coil was then locked again by pouring in wax. Finally the tickler coil was wound on close to the secondary, the number of turns being approximately a quarter of those on the original windings.

As it stands, the grid-cathode circuit of the second detector functions as an ordinary diode circuit while the plate circuit is used solely for regeneration. (The 250K potentiometer controls it.) The audio section of the receiver is fairly straightforward. The audio, picked off the grid-cathode circuit of the 6C5, is fed into one side of a 6SN7, which is R-C-coupled to the other side working as a cathode follower. The

—NOTHING BETTER—
The New Precision Engineered
OAK BOOSTER!
for **TV-FM**
by **OAK ELECTRONICS**
\$39.95



↑ KNOB DOES IT:

The booster that finally satisfies your demands by succeeding where others have failed. The OAK BOOSTER uses Mallory INDUCTUNER (same as used in Dumont, Crosley and Stromberg Carlson TV sets) in a newly engineered circuit on which patent is pending. Provides variable bandwidth to control adjacent channel interference and reduce noise to a minimum. Uses new "Q" multiplier circuit to increase gain enormously.

- A. Turns on Booster & TV set.
- B. Changes "Q" of circuit from 50 to 300 thru new "Q" multiplier circuit (See May "Electronics")
- C. Varies bandwidth from 0.5 MC. to 12 MC.
- D. Allows gain to be controlled from a low value comparable to any other booster, to a high value no other booster can match.

Other boosters use this knob only for On-Off switch, or to switch from low to high channels. OAK REALLY USES THIS KNOB.

- ✓ Highest gain of any booster
- ✓ Dual Input
- ✓ Dual Output
- ✓ Gain adjustable from front knob
- ✓ Automatic On-Off
- ✓ Variable bandwidth controllable from front panel

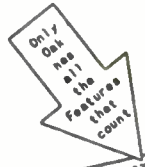

BOOSTER CHECK LIST

FEATURES	BOOSTER						
	Oak Booster	A	B	C	D	E	F
Automatic On-Off	Yes	Yes	No	No	No	No	No
Variable Bandwidth	Yes	No	No	No	No	No	No
Amplifies Fm	Yes	Yes	Yes	No	No	No	No
75 or 300 Input	Yes	No	No	No	No	No	No
Variable Sensitivity	Yes	No	No	No	No	No	Yes
Highest Gain 2-6	Yes	No	Yes	No	No	No	No
Highest Gain 7-13	Yes	Yes	Yes	No	No	No	No
75 or 300 Output	Yes	No	No	No	No	No	No
Widest bandwidth of any booster	Yes	No	No	No	No	Yes	No
Square Wave Type Band Pass Characteristic	Yes	Yes	No	Yes	No	Yes	No

No untuned boosters are rated, as performance is not equal to any tunable boosters.

Order Oak Booster from your jobber today
SALES REPRESENTATIVES

Write for specifications and discounts
OAK ELECTRONICS
150 Oak Street, Buffalo, N. Y.

- Atlanta, Ga. — HENRY BURWELL Co.
- Chicago, Ill. — JEROME KLEKER Co.
- Cleveland, O. — EDWARDS & LOHSE
- Fort Wayne, Ind. — WALTER BIBERICH
- Houston, Tex. — H. H. WILLISON
- Los Angeles — CARL A. STONE ASSOCIATES
- San Francisco — RUSS HINES
- New York City — BURLINGAME ASSOCIATES
- Bronx, N. Y. — V. SALES Co.
- New Jersey — JACK BROWN

EASY TO LEARN CODE

It is easy to learn or increase speed with an Instructograph Code Teacher. Affords the quickest and most practical method yet developed. For beginners or advanced students. Available tapes for beginner's alphabet to typical messages on all subjects. Speed range 5 to 40 WPM. Always ready—no GRM.

ENDORSED BY THOUSANDS!

The Instructograph Code Teacher literally takes the place of an operator-instructor and enables anyone to learn and master code without further assistance. Thousands of successful operators have "acquired the code" with the Instructograph System. Write today for convenient rental and purchase plans.



INSTRUCTOGRAPH COMPANY

4701 Sheridan Rd., Dept. RC, Chicago 40, Ill.

NEW CONDENSER TESTER

Finds Intermittent Condensers Instantly



Pres-probe's sliding tip with variable resistance prevents condenser heating. Tests with power on. Requires no adjustment. Stops guesswork. Saves time. Convenient probe size (7 1/4" long). Satisfaction guaranteed.



See Your Dist. or Order Direct

PRES-PROBE CO.

4034 N. Sixth St., Milwaukee 12, Wisc.

Specially Designed



For ticklish TV soldering, there's no tool like the new 135-watt Weller Gun. Dual spotlights eliminate shadows. Precision balance assures accurate soldering. Long length reaches deep into chassis. 5-second heating saves time and current. Your Weller Gun pays for itself in a few months.



Check This Exclusive Combination of Features

- **5-SECOND HEATING**—No waiting. Saves power.
 - **OVER/UNDER DESIGN**—Tube construction gives bracing action to tip, and improves visibility.
 - **DUAL SOLDERLITE**—Prefocused spotlights completely eliminate shadows—let you see clearly.
 - **LONGER REACH**—Slides easily into the most complicated set-up. Reaches tight corners.
 - **COMPACT DESIGN**—Streamlined and precision balanced for delicate "pin-point" soldering.
 - **TRIGGER-SWITCH CONTROL**—Adjusts heat to the job. No need to unplug gun between jobs.
 - **DUAL HEAT**—Single heat 100 watts; dual heat 100/135 watts; 120 volts, 60 cycles. Handles all light-duty soldering.
- See new Model WD-135 at your distributor, or write for bulletin direct.
- **SOLDERING GUIDE.** Get your new copy of "Soldering Tips"—revised, up-to-date and fully illustrated 20-page booklet of practical soldering suggestions. Price 10c at your distributor, or order direct.

WELLER
ELECTRIC CORP.

828 Packer Street, Easton, Pa.

output of the cathode follower is available on a jack for phones or into a 6V6 for the speaker.

Peak selectivity is around 5 kc or better, which compares favourably with commercial receivers. Provision has been made for break-in by including a send-receive switch which cuts the B-supply to the tube plates. Leads from the switch are brought to two binding posts at the rear of the chassis, enabling the use of a keying relay by transmitting amateurs.

Bands are changed by switching, as the photo indicates. (Only one set of coils is shown in the schematic, for simplicity.) Several types of coils have been used in the receiver, but the set listed in the table will probably meet the widest variety of needs. The clip permits opening the grounded end of L1-a, as on certain bands it is found that better coupling is obtained through capacitive than inductive effect.

Materials for receiver

Resistors: 1—200 ohms, 1 watt; 2—330, 2—1000, 1—2200, 1—5100, 2—10,000, 1—22,000, 1—24,000, 1—33,000, 1—51,000, 1—75,000, 3—100,000 ohms, 1/2 watt; 1—270,000, 2—500,000, 3—1 megohms, 1/4 watt; (potentiometers) 1—10,000, 1—250,000 ohms; 1—500,000 ohms, with switch.

Capacitors: (Electrolytic) 1—dual 8 μ f, 450 volts; 1—25 μ f, 40 volts; (paper) 10—.01 μ f, 2—.05 μ f, 1—.25 μ f, 400 volts; (mica) 1—100 μ f, 1—.0005 μ f, 1—.001 μ f; 1—5 μ f, 1—50 μ f, silver mica; 10—3-30 μ f trimmers; (air) 1—dual 150 μ f ganged, variable; 1—40 μ f variable.

Miscellaneous: 1—power transformer, 300—300 volts, 80 ma, 5 volts 2 amperes, 6.3 volts, 3 amperes; 1—5-inch, 1,000-ohm field, speaker, with output transformer; 1—open circuit phone jack; 3—455 kc i.f. transformers; coils L1, L2 (see text); 1—Yaxley 2-wafer band switch (2-pole, 5-position each wafer); 1—miniature 2-pole, 2-position wafer switch; 1—National ACN dial; 7—octal sockets; 5—insulated binding posts; aluminum or plated steel chassis; 1 each—6J5, 6K8, 6SK7, 6CS, 6SN7-GT, 6V6, 5Y3-GT tubes. Wire, solder, hardware, line cord, alligator clip.

—end—

DIELECTRIC AMPLIFIER

The electron tube now has another competitor, in addition to the transistor and the magnetic amplifier. A dielectric amplifier is being developed and improved. The new amplifier is essentially a ceramic capacitor with a variable dielectric constant. The latter is controlled by a d.c. voltage. As the capacitor reactance varies, it determines how much a.c. (or r.f.) can flow through. See figure. The output power (in load R) is much greater than the input control power.

These amplifiers are described in an article in *Electronics* for Dec., 1951, by A. M. Vincent. According to this article, present amplifiers can provide a gain of a million in one stage. The frequency range is from d.c. to about 10 mc, and there is every indication that the upper limit can be raised much higher.

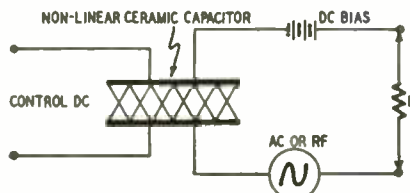

The dielectric of the new type amplifier may be a combination of barium titanate, strontium titanate, lead zirconate, etc. The dielectric constant may be varied over a range of 5:1 or more by a suitable control voltage.

—end—

NEW!



MOSLEY ROOF-THRU

The Leak-Proof Roof Entrance for TV and FM Transmission Line and Rotator Control Cable

Here's the new ROOF-THRU, another MOSLEY product for BETTER TV PICTURES Through More Efficient Installation. ROOF-THRU provides the easiest and most practical method of bringing in lead-in for concealed-in-wall installations using MOSLEY Flush Mounted Sockets.

Why the ROOF-THRU Way Is Best:

- Permits shorter lead-in line resulting in less loss of signal energy—less interference pick-up!
 - Copper flashing and plastic bushing provides perfect seal against leaks!
 - Prolongs life of transmission line by keeping it out of weather!
 - Eliminates unsightly wires on outside of house!
 - Long lasting—weather can't hurt ROOF-THRU!
 - Easy to install on new or old buildings!
- Cat. No. 624 MOSLEY ROOF-THRU
List Price \$5.84
- See the ROOF-THRU and MOSLEY Flush Sockets at your jobber

MOSLEY ELECTRONICS
2125 Lackland Road, Overland, Missouri

DID YOU GET IT? IF NOT
SEND NOW FOR B-A's 136 BIG PAGE FREE CATALOG

BURSTEIN-APPLEBEE CO.
1012-14 McGee St.
Kansas City 6, Mo.

Send your 1952 catalog to:

Name.....
Address.....
City.....State.....

BURSTEIN-APPLEBEE CO.

FREE

Features OF THE NEW 1952



PROOF OF THE NEW O-7 OSCILLOSCOPE'S OUTSTANDING PERFORMANCE

Below are actual, unretouched photographs showing the outstanding frequency response characteristics of the NEW 1952 HEATH-KIT OSCILLOSCOPE, MODEL O-7. To the left is a 10 KC square wave — to the right a 4 MC sine wave as they actually appear on the screen. Two highly severe tests to make on any scope (only the best of scopes will show traces like these) — and the O-7 really comes through.

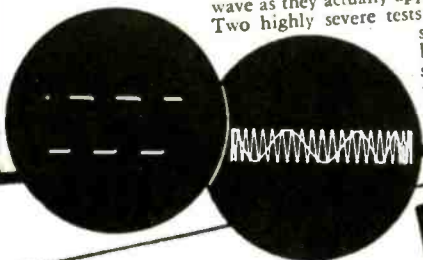

COMPANION VACUUM TUBE VOLTMETERS

Here are the two NEW 1952 VACUUM TUBE VOLTMETER COMPANION PIECES. Matched instruments of new design to open up the whole field of DC, AC, and resistance measurements for you. The new greatly reduced size combines style, beauty, and compactness — The V-5 and AV-1 have the new panel and cabinet construction as shown on the right. A tremendous pair of voltmeters. Small in size but virtual giants in the range of measurements they make.

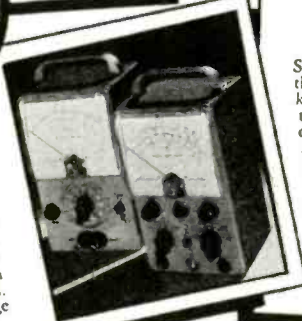

NEW STYLE AND BEAUTY

Style that's modern, yet functional — that's the trend of today — and Heathkits are right up to the minute. Note the cut showing the new V-5 and AV-1 cabinet and panel construction. The front panel and rear cover slide right over the recessed flange of the case thereby eliminating sharp edges and pointed corners. The voltmeter kits aren't "shelf" or "mounted" instruments — they're moved about on the bench a lot and thus the new compact size and specially designed cabinets — Another 1952 Heathkit feature.

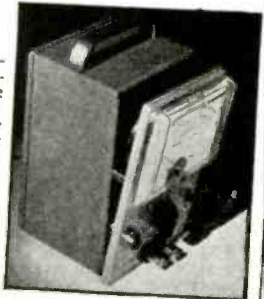

A STATEMENT FROM SIMPSON ELECTRIC CO.

In choosing Simpson Meters for their Heathkit VTVM, the Heath Co. has set a new high standard of kit meter quality. The same high quality of material, workmanship and design that has given Simpson the reputation for building "Instruments That Stay Accurate" is found in the Heathkit Mejer Movement.

SIGNED
SIMPSON ELECTRIC CO.

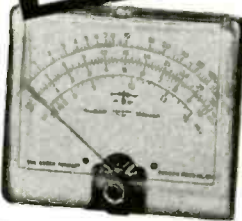

A STATEMENT FROM CHICAGO TRANSFORMER

It is indeed gratifying to note the outstanding sales records you are building with you Heathkits.

This sales success is readily understandable, since we are cognizant of the high quality standards you have established for your component suppliers.

We at Chicago Transformer are proud that our product has contributed to the recognized quality and increasing popularity of Heathkits.

CHICAGO TRANSFORMER DIVISION
Essex Wire Corporation

L. S. RACINE
Vice-President and Sales Manager



HEATHKIT PRECISION RESISTORS

Where exact resistance values are required for instrument accuracy, the Heath Co. has spared no effort in supplying the finest resistors available. Precision resistors as manufactured by Continental Carbon Inc., and Wilcor Corp., meet the rigorous JAN (Joint Army-Navy) specifications and are small in size, extremely non-inductive, highly stable, have a low temperature coefficient, and can be held to great accuracy. You'll find quality components in Heathkits.

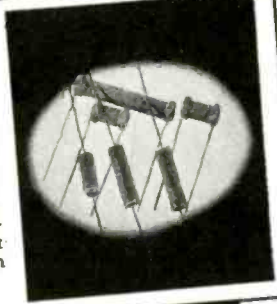

COLLEGES USE HEATHKITS

Colleges and Universities throughout the country are using Heathkits in their electrical engineering, radio, and physics laboratories. Heathkits are the answer to good test equipment at low cost, plus being rugged, dependable, and accurate. Trade schools are having their students build Heathkits to obtain a first hand working knowledge of test equipment and to get the practical experience gained by construction. Heathkits fill school needs.



YOU SAVE BY ORDERING DIRECT FROM MANUFACTURER—USE ORDER BLANK ON LAST PAGE

EXPORT AGENT
ROCKE INTERNATIONAL CORP.
13 E. 40th ST.
NEW YORK CITY (16)
CABLE: ARLAB-N.Y.

The HEATH COMPANY

... BENTON HARBOR 20, MICHIGAN

THE *New* 1952
Heathkit
OSCILLOSCOPE
KIT

MODEL O-7
SHIPPING WEIGHT 24 LBS.

\$43⁵⁰

Features

- New "spot shape" control for spot adjustment — to give really sharp focusing.
- A total of ten tubes including CR tube and five miniatures.
- Cascaded vertical amplifiers followed by phase splitter and balanced push-pull deflection amplifiers.
- Greatly reduced retrace time.
- Step attenuated — frequency compensated — cathode follower vertical input.
- Low impedance vertical gain control for minimum distortion.
- New mounting of phase splitter and deflection amplifier tubes near CR tube base.
- Greatly simplified wiring layout.
- Increased frequency response — useful to 5 Mc.
- Tremendous sensitivity .03V RMS per inch Vertical — .6V RMS per inch Horizontal.
- Dual control in vernier sweep frequency circuit — smoother acting.
- Positive or negative peak internal synchronization.

NEW INEXPENSIVE *Heathkit*
ELECTRONIC SWITCH KIT

The companion piece to a scope — Feed two different signals into the switch, connect its output to a scope, and you can observe both signals — each as an individual trace. Gain of each input is easily set (gain A and gain B controls), the switching frequency is simple to adjust (coarse and fine frequency controls) and the traces can be superimposed for comparison or separated for individual study (position control).

Use the switch to see distortion, phase shift, clipping due to improper bias, both the input and output traces of an amplifier — as a square wave generator over limited range.

The kit is complete; all tubes, switches, cabinet, power transformer and all other parts, plus a clear detailed construction manual.



Model S-2
Shipping Wt. 11 lbs.

Only
\$19⁵⁰

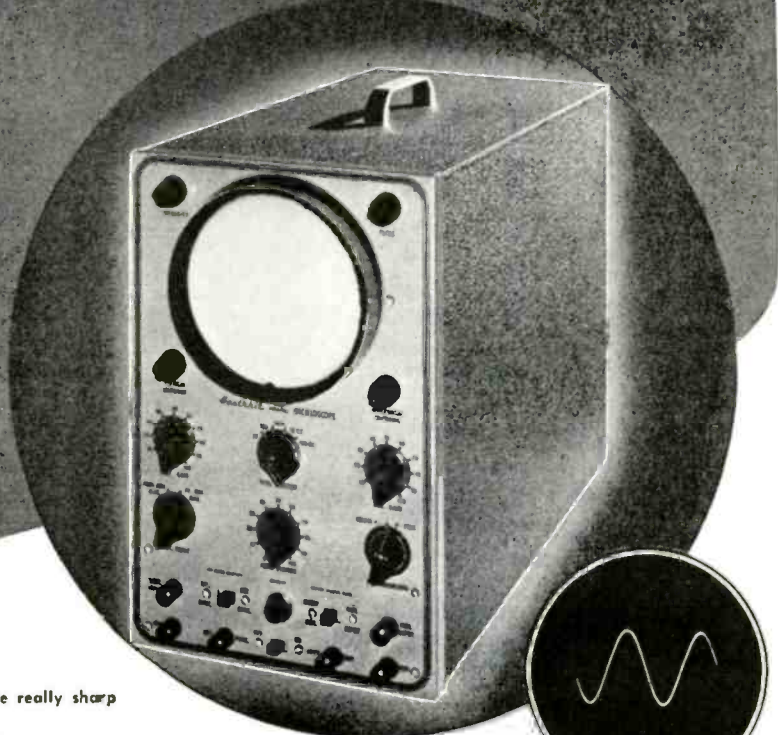

The performance of the NEW, IMPROVED, HEATHKIT 5" OSCILLOSCOPE KIT is truly amazing. The O-7 not only compares favorably with equipment costing 4 and 5 times as much, but in many cases literally surpasses the really expensive equipment. The new, and carefully engineered circuit incorporates the best in electronic design — and a multitude of excellent features all contribute to the outstanding performance of the new scope.

The VERTICAL CHANNEL has a step attenuated, frequency compensated vertical input which feeds a cathode follower stage — this accomplishes improved frequency response, presents a high impedance input, and places the vertical gain control in a low impedance circuit for minimum distortion. Following the cathode follower stage is a twin triode — cascaded amplifiers to contribute to the scope's extremely high sensitivity. Next comes a phase splitter stage which properly drives the push-pull, hi-gain, deflection amplifiers (whose plates are directly coupled to the vertical deflection plates). This fine tube lineup and circuitry give a sensitivity of .03V per inch RMS vertical and useful frequency response to 5 Mc.

The HORIZONTAL CHANNEL consists of a triode phase splitter with a dual potentiometer (horizontal gain control) in its plate and cathode circuits for smooth, proper driving of the push-pull horizontal deflection amplifiers. As in the vertical channel, horizontal deflection amplifier plates are direct coupled to the CR tube horizontal deflection plates (for improved frequency response).

The WIDE-RANGE SWEEP GENERATOR circuit incorporates a twin triode multivibrator stage for producing a good saw-tooth sweep frequency (with faster retrace time). Has both coarse and vernier sweep frequency controls.

And the scope has internal synchronization which operates on either positive or negative peaks of the input signal — both high and low voltage rectifiers — Z axis modulation (intensity modulation) — new spot shape (astigmatism) control for spot adjustment — provisions for external synchronization — vertical centering and horizontal centering controls, wide range focus control — and an intensity control for giving plenty of trace brilliance.

The Model O-7 EVEN HAS GREAT NEW MECHANICAL FEATURES — A special extra-wide CR tube mounting bracket is provided so that the vertical cascade amplifier, vertical phase splitter, vertical deflection amplifier, and horizontal deflection amplifier can mount near the base of the CR tube. This permits close connection between the above stages and to the deflection plates; distributed wiring capacity is greatly reduced, thereby affording increased high frequency response.

The power transformer is specially designed so as to keep its electrostatic and electromagnetic fields to a minimum — also has an internal shield with external ground lead. You'll like the complete instructions showing all details for easily building the kit — includes pictorials, step-by-step construction procedure, numerous sketches, schematic, circuit description. All necessary components included — transformer, cabinet, all tubes (including CR tube), completely punched and formed chassis — nothing else to buy.

YOU SAVE BY ORDERING DIRECT FROM MANUFACTURER—USE ORDER BLANK ON LAST PAGE

HEATHKIT
NEW YORK CITY, N. Y.

The **HEATH COMPANY**

... BENTON HARBOR 20, MICHIGAN

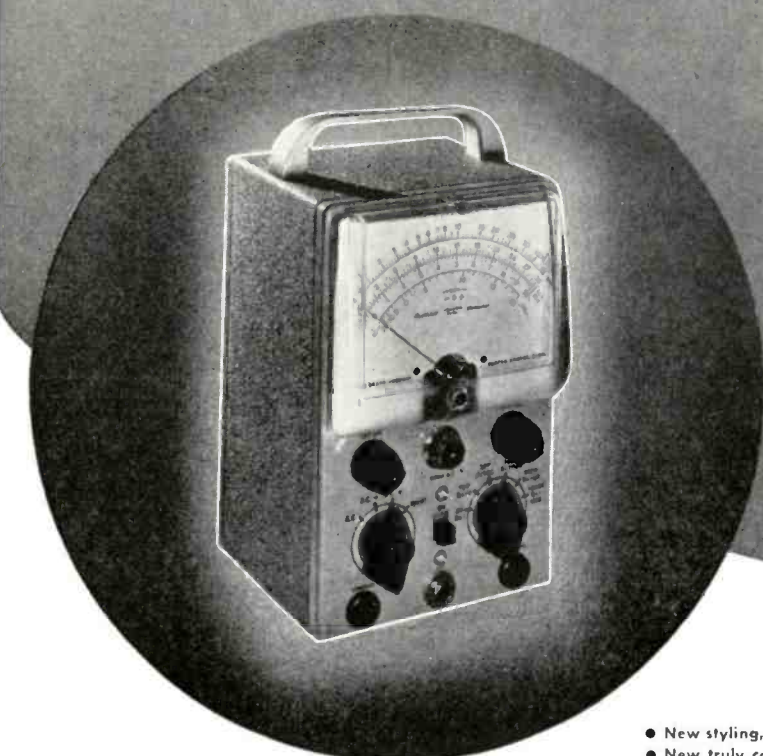

THE *New* 1952

Heathkit
**VTVM
KIT**

MODEL V-5
SHIPPING WT. 5 LBS.

\$24.50

Features

- New styling. — formed case for beauty.
- New truly compact size. Cabinet 4 1/8" deep by 4-11/16" wide by 7 3/8" high.
- Quality 200 microamp meter.
- New ohms battery holding clamp and spring clip — assurance of good electrical contact.
- Highest quality precision resistors in multiplier circuit.
- Calibrates on both AC and DC for maximum accuracy.
- Terrific coverage — reads from 1/2V to 1000V AC, 1/2V to 1000V DC, and .1 to over 1 billion ohms resistance.
- Large, clearly marked meter scales indicate ohms, AC Volts, DC Volts, and DB — has zero set mark for FM alignment.
- New styling presents attractive and professional appearance.

A real beauty — you'll have only highest praise for this NEW MODEL VACUUM TUBE VOLTMETER. Truly a beautiful little instrument — and it's more compact than any of our previous models. Note the new rounded edges on the front panel and rear cover. The size is greatly reduced to occupy a minimum of space on your workbench — yet the meter remains the same large size with plainly marked scales.

A set of specially designed control mounting brackets permit calibration to be performed with greatest ease — also makes for ease in wiring. New battery mounting clamp holds ohms battery tightly into place, and base spring clip insures a good connection to the ohms string of resistors.

The circuitry employs two vacuum tubes — A duo diode operating when AC voltage measurements are taken, and a twin triode in the circuit at all times. The cathode balancing circuit of the twin triode assures sensitive measurements, and yet offers complete protection to the meter movement. Makes the meter burn-out proof in a properly constructed instrument.

Quality components are used throughout — 1% precision resistors in the multiplier circuit — conservatively rated power transformer — Simpson meter movement — excellent positive detent, smooth acting switches — sturdy cabinet, etc.

And you can make a tremendous range of measurements — 1/2V to 1000V AC, 1/2V to 1000V DC, .1 to over 1 billion ohms, and DB. Has mid-scale zero level marking for quick FM alignment. DB scale in red for easy identification — all other scales a sharp, crisp black for easy reading.

A four position selector switch allows operator to rapidly set the instrument for type or reading desired — positions include ACV, DC+V, DC-V, and Ohms. DC — position allow negative voltage to be rapidly taken. Zero adjust and ohms adjust controls are conveniently located on front panel.

Enjoy the numerous advantages of using a VTVM. Its high input impedance doesn't "load" circuits under test — therefore, assures more accurate and dependable readings in high impedance circuits such as resistance coupled amplifiers, AVC circuits, etc. Note the 30,000 VDC probe kit and the RF probe kit — available at low extra cost and specially designed for use with this instrument. With these two probes, you can make DC voltage measurements up to 30,000V, or make RF measurements — added usefulness to an already highly useful instrument.

The instruction manual is absolutely complete — contains a host of figures, pictorials, schematic, detailed step-by-step instructions, and circuit description. These clear, detailed instructions make assembly a cinch.

And every part is included — meter, all controls, pilot light, switches, test leads, cabinet, instruction manual, etc.



Heathkit 30,000V DC
PROBE KIT

A new 30,000 V DC Probe Kit to handle high voltages with safety. For TV service work and all other high voltage applications. Sleek looking — two color molded plastic — Red body and guard — jet black handle. Comes with connector, cable, and PL55 type 300V scale is conveniently multiplied by 100. Can be used with any standard 11 megohm VTVM.

\$550

No. 336 High Voltage Probe Kit
Shipping Wt. 2 lbs.

Heathkit
RF PROBE KIT

This RF Probe Kit comes complete with probe housing, crystal diode detector, connector, lead and plug and all other parts plus clear assembly instructions. Extends range of Heathkit VTVM to 250 Mc. ± 10%. Works on any 11 megohm input VTVM. Specify No. 309 RF Probe Kit.

\$550

Ship. Wt. 1 lb.



YOU SAVE BY ORDERING DIRECT FROM MANUFACTURER — USE ORDER BLANK ON LAST PAGE

EXPORT AGENT
ROCKE INTERNATIONAL CORP.
13 E. 40th ST.
NEW YORK CITY (16)
CABLE: ARLAS-N.Y.

The **HEATH COMPANY**

... BENTON HARBOR 20, MICHIGAN

Heathkit SIGNAL GENERATOR KIT

Model SG-6
Shipping Wt. 7 lbs.

The new Heathkit Signal Generator Kit has dozens of improvements. Covers the extended range of 160 Kc to 50 megacycles on fundamentals and up to 150 megacycles on useful calibrated harmonics; makes this Heathkit ideal as a marker oscillator for TV. Output level can be conveniently set by means of both step attenuator and continuously variable output controls. Instrument has new miniature HF tubes to easily handle the high frequencies covered.

Uses 6C4 master oscillator and 6C4 sine wave audio oscillator. The kit is transformer operated and a husky selenium rectifier is used in the power supply. All coils are precision wound and checked for calibration making only one adjustment necessary for all bands.

New sine wave audio oscillator provides internal modulation and is also available for external audio testing. Switch provided allows the oscillator to be modulated by an external audio oscillator for fidelity testing of receivers. Comes complete, all tubes, cabinet, test leads, every part. The instruction manual has step-by-step instructions and pictorials. It's easy and fun to build a Heathkit Model SG-6 Signal Generator.



\$19.50

Heathkit CONDENSER CHECKER KIT

Only
\$19.50

Model C-2
Shipping Wt. 6 lbs.



Checks all types of condensers — paper — mica — ceramic — electrolytic. All condenser scales are direct reading and require no charts or multipliers. Covers range of .00001 MFD to 1000 MFD. A Condenser Checker that anyone can read. A leakage test and polarizing voltage for 20 to 500 V provided. Measures power factor of electrolytics between 0% and 50% and reads resistance from 100 ohms to 5 megohms. The magic eye indicator makes testing easy.

The kit is 110V 60 cycle transformer operated and comes complete with rectifier tube, magic eye tube, cabinet, calibrated panel and all other parts. Has clear detailed instructions for assembly and use.

NEW Heathkit SIGNAL TRACER AND UNIVERSAL TEST SPEAKER KIT

\$19.50

Model T-2
Shipping Wt. 7 lbs.

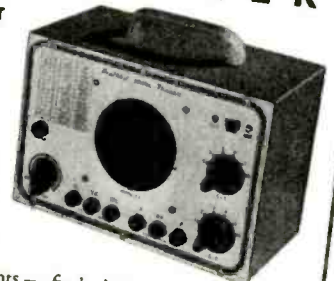

The popular Heathkit Signal Tracer has now been combined with a universal test speaker at no increase in price. The same high quality tracer follows signal from antenna to speaker — locates intermittents — finds defective parts quicker — saves valuable service time — gives greater income per service hour. Works equally well on broadcast, FM, or TV receivers. The test speaker has an assortment of switching ranges to match phones, pickups and PA systems. Also tests micro-60 cycle power transformer, tubes, test probe, all necessary parts, and detailed instructions for assembly and use.



Model TC-1
Shipping Wt. 12 lbs.

\$29.50

Heathkit TUBE CHECKER KIT

The Tube Checker is a MUST for radio repair men. Often customers want to SEE tubes checked, and a checker like this builds customer confidence. In your repairing, you will have a multitude of tubes to check — quickly. The Heathkit tube checker will serve all these functions — it's good looking (with a polished birch cabinet and an attractive two color panel) — checks 4, 5, 6, 7 prong Octals, Loctals, 7 prong miniatures, 9 prong miniatures, pilot lights, and the Hytron 5 prong types. AND IT'S FAST TO OPERATE — the gear driven, free-running roll chart lists hundreds of tubes, and the smooth acting, simplified switching arrangement gives really rapid set-ups.

The testing arrangement is designed so that you will be able to test new tubes of the future — without even waiting for factory data — protection against obsolescence.

You can give tubes a thorough testing — checks for opens, shorts, each element individually, emission, and for filament continuity. A large BAD-?-GOOD meter scale is in three colors for easy reading and also has a "line-set" mark.

You'll find this tube checker kit a good investment — and it's only \$29.50.

YOU SAVE BY ORDERING DIRECT FROM MANUFACTURER—USE ORDER BLANK ON LAST PAGE

EXPORT AGENT
ROCKE INTERNATIONAL CORP.
13 E. 40th ST.
NEW YORK CITY (16)
CABLE: 85180-N.Y.

The **HEATH COMPANY**

... BENTON HARBOR 20, MICHIGAN

New LABORATORY LINE HEATHKITS

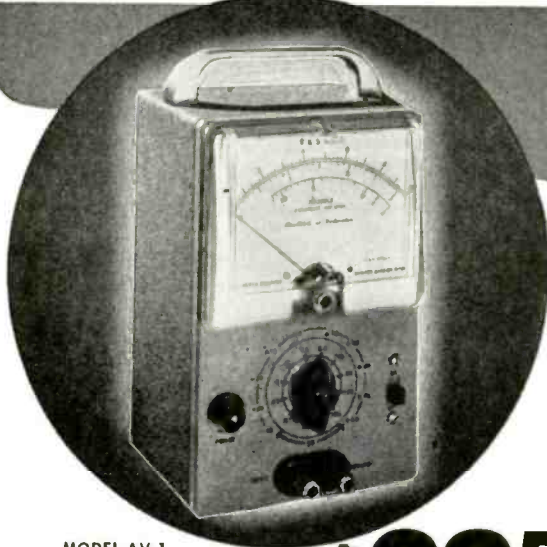

NEW *Heathkit*
A.C. VACUUM TUBE
VOLTMETER KIT

Now — as a Heathkit — at a price anyone can afford, an AC VTVM. A new kit to make possible those sensitive AC measurements required by audio enthusiasts, laboratories, and experimentors. Here is the kit that the audio men have been looking for. Its tremendous range of coverage makes possible measurements of audio amplifier frequency response — gain or loss of audio stages — characteristics of audio filters and attenuators — hum investigation — and literally a multitude of others. Ten ranges consisting of full scale .01, .03, .1, 3, 1, 3, 10, 30, 100, 300 volts RMS assure easy and more accurate readings. Ten ranges on DB provide for measurements from -52 to +52 DB. Frequency response within 1 DB from 20 cycles to 50 KC.

The ingenious circuitry incorporates precision multiplier resistors for accuracy, two amplifier stages using miniature tubes, a unique bridge rectifier meter circuit, quality Simpson meter with 200 microampere movement, and a clean layout of parts for easy wiring. A high degree of inverse feedback provides for stability and linearity.

Simple operation is accomplished by the use of only one control, a range switch which changes the voltage ranges in multiples of 1 and 3, and DB ranges in steps of 10.

The instrument is extremely compact, cabinet size — 4 1/8" deep x 4-11/16" wide x 7 3/8" high, and the newly designed cabinet makes this the companion piece to the VTVM. For audio work, this kit is a natural.

MODEL AV-1
Shipping weight 5 lbs.

\$29⁵⁰

NEW *Heathkit*
AUDIO FREQUENCY METER KIT

MODEL AF-1
Shipping weight 12 lbs.



A NEW Heathkit Audio Frequency Meter — the ideal instrument for determining frequencies from 20 cycles to 100 KC. Set the selector switch to the proper range — feed the signal into the input terminals — and read the frequency from the meter — completely simple to operate, and yet dependable results.

Quality Simpson 200 microampere meter has two plainly marked scales (0-100 0-300). These scales, read in conjunction with the seven position selector switch, give full scale readings of 100, 300, 1000, 3000, 10,000, 30,000, and 100,000 cycles. Convenient ranges for fast and easy readings.

\$34⁵⁰

For greatest accuracy, the 1-3-10 ratio of ranges is maintained and each range has individual calibrating control.

Input impedance is high (1 megohm) for negligible circuit loading. A signal and a change in signal voltage between these limits will not affect the meter reading. In addition, input wave shape is not critical (the unit will read the frequency of either sine wave or square wave input).

The tube complement consists of a 6SJ7 amplifier and clipper, 6V6 amplifier and clipper, 6H6 meter pulse rectifier, 6X5 power supply rectifier, and OD3/VR150 voltage regulator.

Construction is simple, and quality components are used throughout.

NEW *Heathkit*
INTERMODULATION ANALYZER KIT

Intermodulation testing of audio equipment is rapidly being accepted by more and more engineers and audio experts as the best way to determine the characteristics of audio amplifiers, recording systems, networks, etc. — shows up those undesirable characteristics which contribute to listening fatigue when all other methods fail.

The Heathkit Intermodulation Analyzer supplies a choice of two high frequency (3000 cycles and a higher frequency (60 cycles) and one low frequency (60 cycles). Both 1:1 or 4:1 ratios of low to high frequencies can be set up for IM testing, and the ratios are easily set by means of a panel control and the instrument's own VTVM. An output level control supplies the mixed signal at the desired level with an output impedance of two thousand ohms. The Analyzer section has input level control and proper filter circuits feeding the instrument's VTVM to read intermodulation directly on full scale ranges of 30%, 10% and 3%. Built-in power supply furnishes all necessary voltages for operating the instrument.

You won't want to be without this new and efficient means of testing



MODEL IM-1
Shipping wt. 18 lbs.

\$39⁵⁰

NEW
Heathkit **SQUARE WAVE GENERATOR KIT**

The new Heathkit Square Wave Generator Kit with its 100 KC square wave opens an entirely new field of audio testing. Square wave testing over this wide range will quickly show high and low frequency response characteristics of circuits — permit easy adjustment of high frequency compensating networks used in video amplifiers — identify ringing in circuits — demonstrate transformer characteristics, etc.

The circuitry consists of a multivibrator stage, a clipping and squaring stage, and a cathode follower output stage. The power supply is transformer operated and utilizes a full wave rectifier tube with 2 sections of LC filtering.

As a multivibrator cannot be accurately calibrated, a provision is provided to allow the instrument to be accurately synchronized with an accurate external source when extreme accuracy is required.

The low impedance output is continuously variable between 0 and 25 volts and operation is simple. You'll really appreciate the wide range of this instrument. 10 cycles to 100 kilocycles — continuously variable. Kit is complete with all parts and instruction manual, and is easy to build.

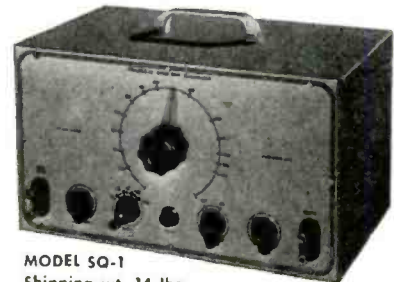

MODEL SQ-1
Shipping wt. 14 lbs.

\$29⁵⁰

YOU SAVE BY ORDERING DIRECT FROM MANUFACTURER—USE ORDER BLANK ON LAST PAGE

EXPORT AGENT
ROCKE INTERNATIONAL CORP.
2 E. 40th ST.
NEW YORK CITY (16)
CALIF. AREA - N.Y.

The **HEATH COMPANY**

... BENTON HARBOR 20, MICHIGAN

Heathkit IMPEDANCE BRIDGE KIT



Model 1B-1B
Shipping Wt. 15 lbs.

\$69⁵⁰

This Impedance Bridge Kit is really a favorite with schools, industrial laboratories, and serious experimenters. An invaluable instrument for those doing electrical measurements work. Reads resistance from .01 Ohms to 10 meg., capacitance from .00001 to 100 MFD, inductance from 10 microhenries to 100 henries, dissipation factor from .002 to 1, and storage factor from 1 to 1000. And you don't have to worry about selecting the proper bridge circuit for the various measurements—the instrument automatically makes the correct circuit when you set up for taking the measurement you want. Bridge utilizes Wheatstone, Hay, Maxwell, and capacitance comparison circuits for the wide range and types of measurements possible. And it's self powered—has internal battery and 1000 cycle hummer. No external generator required—has provisions for external generator if measurements at other than 1000 cycles are desired. Kit utilizes only highest quality parts, General Radio main calibrated control. Mallory ceramic switches, excellent 200 microamp zero center galvanometer, laboratory type binding posts with standard 3/4 inch centers, 1% precision ceramic-body type multiplier resistors, beautiful birch cabinet and ready calibrated panel. (Headphones not included.)

Take the guesswork out of electrical measurements—order your Heathkit Impedance Bridge kit today—you'll like it.

Heathkit LABORATORY RESISTANCE DECADE KIT



\$19⁵⁰

Shipping Wt. 4 lbs.

An indispensable piece of laboratory equipment—the Heathkit Resistance Decade Kit gives you resistance settings from 1 to 99,999 ohms IN ONE OHM STEPS. For greatest accuracy, 1% precision ceramic-body type resistors and highest quality ceramic wafer switches are used.

Designed to match the Impedance Bridge above, the Resistance Decade Kit has a beautiful birch cabinet and attractive panel. It's easy to build, and comes complete with all parts and construction manual.

Heathkit LABORATORY POWER SUPPLY KITS

Limits:

No load.....	Variable 150-400V DC
25 MA.....	Variable 30-310V DC
50 MA.....	Variable 25-250V DC

Higher loads: Voltage drops off proportionally
Every experimenter needs a good power supply for electronic setups of all kinds. This unit has been expressly designed to act as a HV supply and a 6.3 V filament voltage source. Voltage control allows selection of HV output desired (continuously variable within limits outlined), and a Volts-Ma switch provides choice of output metering. A large plainly marked and direct reading meter scale indicates either DC voltage output (Range of meter 0-500V D.C., 0-200 Ma. D.C.). Instrument has convenient stand-by position and pilot light.



\$29⁵⁰

Model PS-1.....Ship. Wt. 20 lbs.

Comes with power transformer, filament transformer, meter, 5Y3 rectifier, two 1619 control tubes, completely punched and formed chassis, panel, cabinet, detailed construction manual, and all other parts to make the kit complete.

Heathkit ECONOMY . . . 6 WATT AMPLIFIER KIT

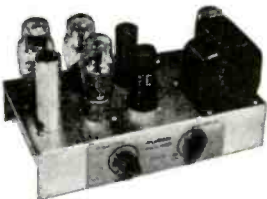

Model A-4
Ship. Wt. 8 lbs.

\$12⁵⁰

No. 304 12 inch speaker . . . **\$6.95**

This fine Heathkit Amplifier was designed to give quality reproduction and yet remain low in price. Has two preamp stages, phase inverter stage, and push-pull beam power output. Comes complete with six tubes, quality output transformer (to 3-4 ohm voice coil), husky cased power transformer and all other parts. Has tone and volume controls. Instruction manual has pictorial for easy assembly. Six watts output with response flat $\pm 1\frac{1}{2}$ db from 50 to 15,000 cycles. A quality amplifier kit at a low price. Better build one.

Heathkit HIGH FIDELITY . . . 20 WATT AMPLIFIER KIT

Our latest and finest amplifier—the model A-6 (or A-6A) is capable of a full 20 Watts of high fidelity output—good faithful reproduction made possible through careful circuit design and the use of only highest quality components. Frequency response within ± 1 db from 20-20,000 cycles. Distortion at 3 db below maximum power output (at 1000 cycles) is only .8%. The power transformer is rugged and conservatively rated and will deliver full plate and filament supply with ease. The output transformer was selected because of its exceptionally good frequency response and wide range of output impedances (4-8-16-150-600 ohms). Both are Chicago Transformers in drawn steel case for shielding and maximum protection to windings. The unit has dual tone controls to set the output for the tonal quality desired—treble control attenuates up to 15 db at 10,000 cycles—bass control gives bass boost up to 10 db at 50 cycles. Tube complement consists of 5U4C rectifier, 6SJ7 voltage amplifier, 6SN7 amplifier and phase splitter, and two 6L6's in push-pull output. Comes complete with all parts and detailed construction manual. (Speaker not included.)
MODEL A-6: For tuner and crystal phono inputs. Has two position selector switch for convenient switching to type of input desired.



\$33⁵⁰

Shipping Wt. 18 lbs.

MODEL A-6A: Features an added 6SJ7 stage (preamplifier) for operating from variable reluctance cartridge phono pickup, mike input, and either tuner or standard crystal phono pickup. A three position selector switch provides flexible switching. **\$35.50**
Shipping Wt. 18 lbs.

YOU SAVE BY ORDERING DIRECT FROM MANUFACTURER—USE ORDER BLANK ON LAST PAGE

The **HEATH COMPANY**

. . . BENTON HARBOR 20, MICHIGAN



NEW 1952 *Heathkit*
**BATTERY ELIMINATOR
 KIT**

- Can be used as battery charger.
- Continuously variable output 0 - 8 Volts — not switch type.
- Heavy duty Mallory 17 disk type magnesium copper sulfide rectifier.
- Automatic overload relay for maximum protection. Self-resetting type.
- Ideal for battery, aircraft and marine radios.
- Dual Volt and Ammeters read both voltage and amperage continually — no switching.

The new Heathkit Model BE-2 incorporates the best. Continuously variable output control is of the variable transformer type with smooth wiper type contacts.

There are no switches or steps and voltage between 0 and 8 Volts is available at 10 Amperes continuous and 15 Amperes intermittent. Maximum safety from overloads and shorts provided by automatic overload relay which resets itself when overload is removed.

The new rectifier is a 17 plate Mallory magnesium copper sulfide type. This is the most rugged type available for long trouble-free use.

Output is continuously metered by both a 0 - 10 Volt Voltmeter and a 0 - 15 Amp Ammeter. Shorted vibrators indicated instantly by ammeter.

Equip now for all types of service — aircraft — marine — auto and battery radios — this inexpensive instrument vastly increases service possibilities — better be ready when the customer walks in.

Model BE-3
 Shipping Wt. 17 lbs.

NEW *Heathkit*
**SINE AND SQUARE WAVE
 AUDIO GENERATOR KIT**

Designed with versatility, usefulness, and dependability in mind, the AG-7 gives you the two most needed wave shapes right at your fingertips — the sine wave and the square wave.

The range switch and plainly calibrated frequency scale give rapid and easy frequency selection, and the output control permits setting the output to any desired level.

A high-low impedance switch sets the instrument for either high or low impedance output — on high to connect a high impedance load, and on low to work into a low impedance transformer with negligible DC resistance.

Coverage is from 20 to 20,000 cycles, and distortion is at a minimum — you can really trust the output wave shape.

Six tubes, quality 4 gang tuning condenser, power transformer, metal cased filter condenser, 1% precision resistors in the frequency determining circuit, and all other parts come with the kit — plus, a complete construction manual — A tremendous kit, and the price is truly low.

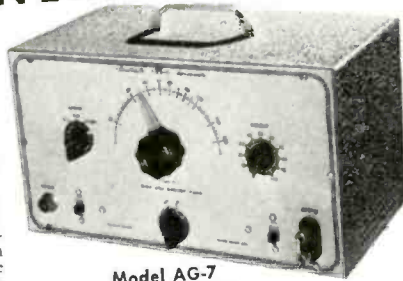

Model AG-7
 Shipping Wt. 15 lbs.

\$34.50

THE NEW *Heathkit*
HANDITESTER KIT

A precision portable volt-ohm milliammeter. Uses only high quality parts — All precision 1% resistors, three deck switch for trouble-free mounting of parts, specially designed battery mounting bracket, smooth acting ohm adjust control, beautiful molded bakelite case, 400 micro-amp meter movement, etc.

DC and AC voltage ranges 10 - 30 - 300 - 1000 - 5000V.
 Ohms range 0 - 3000 and 0 - 300,000. Range Milliamperes 0 - 10 Ma, 0 - 100 Ma.
 Easily assembled from complete instructions and pictorial diagrams.



\$13.50

Model M-1
 Shipping Wt. 3 lbs.

NEW *Heathkit*

T.V. ALIGNMENT GENERATOR KIT

Here is an excellent TV Alignment Generator designed to do TV service work quickly, easily, and properly. The Model TS-2 when used in conjunction with an oscilloscope provides a means of correctly aligning television receivers.

The instrument provides a frequency modulated signal covering, in two bands, the range of 10 to 90 Mc. and 150 to 230 Mc. — thus, ALL ALLOCATED TV CHANNELS AS WELL AS IF FREQUENCIES ARE COVERED.

An absorption type frequency marker covers from 20 to 75 Mc. in two ranges — therefore, you have a simple, convenient means of frequency checking of IF's, independent of oscillator calibration.

Sweep width is controlled from the front panel and covers a sweep deviation of 0-12 Mc. — all the sweep you could possibly need or want.

And still other excellent features are: Horizontal sweep voltage available at the front panel (and controlled with a phasing control — both step and continuously variable attenuation for setting the output signal to the desired level — a convenient instrument stand-by position — vernier drive of both oscillator and marker tuning condensers — and blanking for establishing a single trace with base reference level. Make your work easier, save time, and repair with confidence — order your Heathkit TV Alignment Generator now!

Model TS-2
 Shipping Wt. 20 lbs.

\$39.50

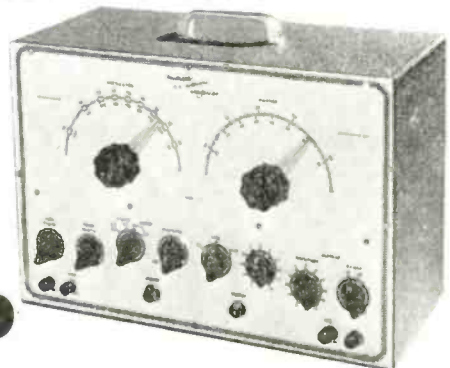

YOU SAVE BY ORDERING DIRECT FROM MANUFACTURER—USE ORDER BLANK ON LAST PAGE

SOLE AGENT
ROCKE INTERNATIONAL CORP.
 31-30th ST.
 NEW YORK CITY 16
 CABLE 48141-N.Y.

The **HEATH COMPANY**

... BENTON HARBOR 20, MICHIGAN

Heathkit RECEIVER & TUNER KITS for AM and FM



Model BR-1 Broadcast Model Kit covers 550 to 1600 Kc. Shipping Wt. 10 lbs.

\$19⁵⁰



Model AR-1 3 Band Receiver Kit covers 550 Kc. to over 20 Mc. continuous. Extremely high sensitivity. Shipping Wt. 10 lbs.

\$23⁵⁰

TWO HIGH QUALITY *Heathkit* SUPERHETRODYNE RECEIVER KITS

Two excellent Heathkits. Ideal for schools, replacement of worn out receivers, amateur and custom installations. Both are transformer operated quality units. The best of materials used throughout—six inch calibrated slide rule dial—quality power output transformers—dual iron core shielded. I.F. coils—metal cased filter condenser. The chassis has phono input jacks, 110 Volt output for phono motor and there is a phono-radio switch on panel. A large metal panel simplifying installation in used console cabinets is included. Comes complete with tubes and instruction manual incorporating pictorials and step-by-step instructions (less speaker and cabinet). The three band model has simple coil turret which is assembled separately for ease of construction.

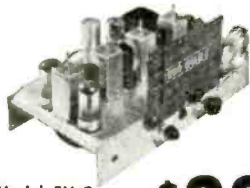

Model FM-2
Ship. Wt. 9 lbs.

\$22⁵⁰

TRUE FM FROM *Heathkit* FM TUNER KIT

The Heathkit FM Tuner Model FM-2 was designed for best tonal reproduction. The circuit incorporates the most desirable FM features—true FM. Utilizes 8 tubes: 7E5 Oscillator, 6SH7 mixer, two 6SH7 IF amplifiers, 6SH7 limiter, two 7C4 diodes as discriminator, and 6X5 rectifier. The instrument is transformer operated making it safe for connection to any type receiver or amplifier. Has ready wound and adjusted RF coils, and 2 stages of 10.7 Mc IF (including limiter). A calibrated six inch slide rule dial has vernier drive for easy tuning. All parts and complete construction manual furnished.



MAIL TO THE
HEATH COMPANY
BENTON HARBOR 20,
MICHIGAN

ORDER BLANK

From _____

SHIP VIA
 Parcel Post
 Express
 Freight
 Best Way

Quantity	Item	Price	Quantity	Item	Price
	Heathkit Oscilloscope Kit — Model O-7			Heathkit H.V. Probe Kit — No. 336	
	Heathkit VTVM Kit — Model V-5			Heathkit R.F. Signal Gen. Kit — Model SG-6	
	Heathkit FM Tuner Kit — FM-2			Heathkit Condenser Checker Kit — Model C-2	
	Heathkit Broadcast Receiver Kit — Model BR-1			Heathkit Handitester Kit — Model M-1	
	Heathkit Three Band Receiver Kit—Model AR-1			Heathkit Power Supply Kit — Model PS-1	
	Heathkit Amplifier Kit — Model A-4			Heathkit Resistance Decade Kit — Model RD-1	
	Heathkit Amplifier Kit — Model A-6 (or A-6A)			Heathkit Impedance Bridge Kit — Model IB-1B	
	Heathkit Tube Checker Kit — Model TC-1			Heathkit A.C. VTVM-KIT — Model AV-1	
	Heathkit Audio Generator Kit — Model AG-7			Heathkit Intermodul. Analyzer Kit—Model IM-1	
	Heathkit Battery Eliminator Kit — Model BE-2			Heathkit Audio Freq. Meter Kit — Model AF-1	
	Heathkit Electronic Switch Kit — Model S-2			Heathkit Square Wave Gen. Kit — Model SQ-1	
	Heathkit T.V. Alignment Gen. Kit — TS-2				
	Heathkit Signal Tracer Kit — Model T-2				
	Heathkit R.F. Probe Kit — No. 309				

On Parcel Post Orders, include postage for weight shown and insurance. (We insure all shipments.)
On Express Orders, do not include transportation charges—they will be collected by the Express Agency at time of delivery.

Enclosed find Check Money Order for _____

Please ship C.O.D. Postage enclosed for _____ lbs.

ALL PRICES SUBJECT TO CHANGE WITHOUT NOTICE

EXPORT AGENT
ROCKE INTERNATIONAL CORP.
13 E. 40th St.
NEW YORK CITY (14)
CABLE: ARLAB-N.Y.

The **HEATH COMPANY**
... BENTON HARBOR 20, MICHIGAN

FREQUENCY MODULATOR

Patent No. 2,561,989
 Carl J. Madsen, Hingham, Mass.
 (Assigned to Tropical Radio
 Telegraph Co.)

This modulator produces FM in proportion to an a.c. signal. It can be used in a facsimile circuit. In this application a photocell converts variations in density (of a photograph for example) to a.c. With this new invention, the a.c. produces a corresponding FM wave which may be transmitted by radio. At the receiver, the detected FM results in a.c. again. This voltage controls the density of a sensitized sheet on which the original image is reproduced.

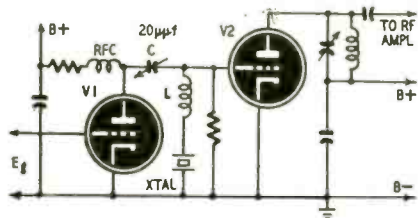

The a.c. signal E_g is amplified by V1. The resistance of this tube is controlled by the signal. On positive alternations of the signal, the tube's resistance is low and C is effectively shunted across the crystal circuit. This lowers the frequency of oscillator tube V2. When the signal is negative the resistance of V1 is high. Then C has less effect, so the crystal oscillation tends to rise toward the natural frequency of the crystal. L is a feedback coil which permits the crystal to operate over a wide range of frequencies.

The system is essentially narrow-band, a change of 2-3 volts at the grid of V1 resulting in an output deviation in the order of a few hundred cycles.

D.C. AMPLIFIER

Patent No. 2,571,915

Arthur O. McCoubrey, Forest Hills, Pa.
 (Assigned to Westinghouse Elec. Corp.)

It is difficult to amplify a weak d.c. signal satisfactorily. Sensitive amplifiers using tubes are subject to non-uniform emission and d.c. level drift which distort the signal. For this reason it is common to convert the d.c. to a.c. before amplification. Then the voltage is rectified to obtain the amplified d.c. This new circuit uses a novel and effective method to convert d.c. to a.c.

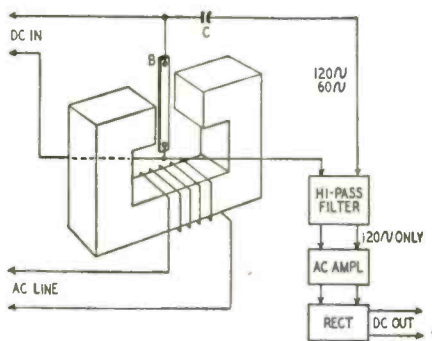

Bismuth and platinum are two of the "magneto-resistive" metals whose resistance is changed by a magnetic field (see page 41, Nov. 1951 issue). A strip of bismuth B is fixed between the poles of an electromagnet. The a.c. line energizes the magnet. Each field alternation (regardless of polarity) changes the resistance. The resistance of B is varied at twice the frequency of the excitation voltage. Thus, with 60-cycle excitation the resistance changes 120 times a second.

When the d.c. signal flows through B, it produces a voltage drop. This voltage is modulated by the magnetic field 120 times a second. This frequency passes through C to a highpass filter. The fundamental frequency (60 cycles), present across B due to ordinary transformer action, is filtered out.

OAK RIDGE CRT TESTER

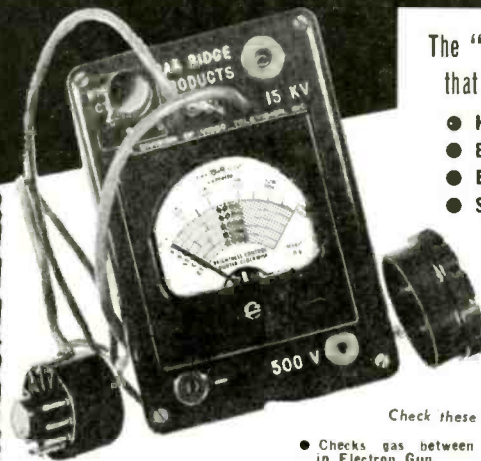

The "CATHETTE" is the ONLY CRT Tester* that checks ALL the following:

- HIGH VOLTAGE BREAKDOWN
- BEAM CURRENT MEASUREMENT
- ELECTRON GUN CONDUCTANCE
- SHORTS BETWEEN ANY ELEMENTS

Ask to see this INDISPENSABLE new tool at your nearest jobber. You'll agree that it's a MUST for every TV Serviceman today!

MODEL 106 "CATHETTE" CRT Tester, net. **\$29.95**

*Pat. applied for.

Check these additional "Cathette" Features:

- Checks gas between elements in Electron Gun
- Checks gas between High Voltage Anode and Electron Gun
- Checks conductance between Cathode, Control Grid, and Screen Grid
- Checks filament continuity
- Checks high voltage on Anode
- Checks Screen to Control Grid voltage from set
- Checks Control Grid to Cathode voltage from set
- Checks leakage
- Tests and positions Ion Trap
- Checks brightness control voltage
- Easy-to-read calibrated DC Voltage scales (0-500V, 0-15KV)
- Easy-to-read tube test scales
- Supplied with duo-decal plug and socket. (Special adaptors available as accessories)
- Pocket size: 5 1/2"x3 3/4"x2 1/4". Shp. wt. 3 lbs.

MODEL 108 POWER SUPPLY
 (Pocket size, same as above.) Used in conjunction with Cathette CRT Tester, permits testing of Picture Tubes, in carton!
\$19.95 net



Send NOW for your copy of our complete new catalog, illustrating and describing the above equipment, as well as all other OAK RIDGE TV Test Instruments.
 Cable Address: "UNIONTEX" N.Y.

OAK RIDGE PRODUCTS

37-01 Vernon Blvd. Long Island City 1, N. Y.
 Mfg. Division of VIDEO TELEVISION, INC.

Oak Ridge Products, Dept. C
 37-01 Vernon Blvd., Long Island City 1, N. Y.
 Please send your complete new OAK RIDGE Catalog at once, to:

Name.....
 Address.....
 City..... State.....

IT'S A SALES NATURAL
 Because It's
TIP-PROOF



Tip-Proof
 Model No. TA 135
INDOOR TV ANTENNA



Complete with twin lead.

Closes TV set sales on-the-spot. One reason why over 1,000,000 have already been sold!

See Your Jobber or Write for Brochure No. 16



MANUFACTURING CO., INC.
 6129 16th Ave. Brooklyn 4, New York
 FIRST in Television Antennas and Accessories

LEARN

Television-Radio Electricity

REFRIGERATION-ELECTRONICS
 IN THE GREAT SHOPS OF **COYNE**

TRAIN QUICKLY! OLDEST, BEST EQUIPPED SCHOOL OF ITS KIND in U.S. Young and Older Men....

Come to the Great Shops of Coyne in Chicago. Get practical training in TELEVISION-RADIO or ELECTRICITY—vital in Defense Program. Prepare now for a better job or better service rating.

START NOW—PAY LATER

You can finance most of your tuition, pay for it later in easy monthly payments. Special plan for men of Draft Age. Part time employment service available.

FREE BOOK Clip coupon for Big Free Illustrated Book. Indicate below, course that interests you. No salesman will call. Act NOW.

COYNE [SCHOOL] B. W. Cooke, President
 A TECHNICAL TRADE INSTITUTE CHARTERED NOT FOR PROFIT
 Established 1899
 500 S. Paulina, Chicago

ELECTRICITY ★ TELEVISION RADIO ★ REFRIGERATION ★ ELECTRONICS

B. W. COOKE, Pres.
 COYNE School
 500 S. Paulina St., Chicago 12, Ill. Dept. 22-81H

Send FREE BOOK and full details on:
 TELEVISION-RADIO ELECTRICITY

NAME.....
 ADDRESS.....
 CITY..... STATE.....

THE JUNIOR SUPER-METER

THE MOST COMPLETE AND COMPACT MULTI-SERVICE INSTRUMENT EVER DESIGNED!

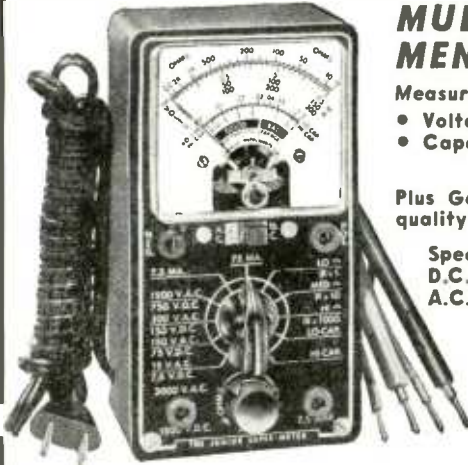

- Measures:
- Voltage
 - Current
 - Resistance
 - Capacity
 - Reactance
 - Inductance
 - Decibels

Plus Good-Bad scale for checking the quality of electrolytic condensers.

- Specifications:
- D.C. Volts: 0-7.5/75/150/750/1500 Volts.
 - A.C. Volts: 0-15/150/300/1500/3000 Volts.
 - Resistance: 0-10,000/100,000 ohms, 0-10 Mgms.
 - D.C. Current: 0-7.5/75 Ma, 0-7.5 amps.
 - Capacity: .001 Mfd.—2 Mfd. .1 Mfd.—20 Mfd.
 - Electrolytic Leakage: Reads quality of electrolytics at 150 Volt test potential.
 - Decibels: -10 Db. to +18 Db. +10 Db. to +38 Db. +38 Db. to +58 Db.
 - Reactance: 15 ohms—25 K ohms 15 K ohms—2.5 Megohms.
 - Inductance: .5 Henry—50 Henries 30 Henries—10 K Henries.

Handsome round cornered molded bakelite case 3 1/8" x 5 7/8" x 2 1/4" complete with all test leads and instructions.

\$21.40

SOLD ON EASY PAYMENTS AT THE NET CASH PRICE

No interest or carrying charges added. Simply remit \$5.40 with order, pay balance \$4.00 per month for four months.

MOSS ELECTRONIC DIST. CO., INC.
Dept. B-10, 38 Murray St., New York 7, N. Y.

4 SENSATIONAL VALUES FOR IMMEDIATE DELIVERY FROM STOCK

NOT KITS but completely wired and factory guaranteed instruments

TEST-CRAFT Model TC-50

Tube and Set Tester

tests all tubes up-to-date incl. 4, 5, 6, 7L, octals, loctals, television, magic eye, thyrtors, single ended, floating filament, mercury vapor, new miniatures, etc.

Multimeter Specifications: AC and DC Voltage Ranges: 0-1-100-1000-5000. DC Current Ranges: 0-10/100/1 Amp. Low Resistance Range: 0-10,000 Ohms. Medium Resistance Range: 0-100,000 Ohms. High Resistance Range: 0-1 megohm.

Complete with test leads and full instructions

Only **\$39.50**

MODEL 999 Combination Television, F.M. and A.M. Signal Generator and Signal Tracer



Only **\$28.85**

Generates R.F. frequencies from 150 kilocycles to 50 megacycles. Battery operated, no external source of current required. Positive action attenuator provides effective output control at all times. R.F. is obtainable separately or modulated by the Audio Frequency.

Complete with test leads and full instructions

TEST-CRAFT Model TC-10

Quality Multitester

Only **\$12.85**

AC and DC Voltage Ranges: 0-5/15/150/1500/3000 Volts. DC Current Ranges: 0-5/50 ma. 0-1. 5 Amps. Resistance Ranges: 0-100 ohms, 0-100 K. Size: 6"x3 1/2"x2".

Complete with batteries and full instructions.

TEST-CRAFT Model TC-75

Combination Test Speaker and Signal Tracer

Only **\$29.50**

plus speaker substitution
plus resistor tester
plus condenser tester
plus output indicator

plus field substitutor
plus voice coil substitution

Complete with full instructions

25% with order, balance C.O.D. or full check with order.

METROPOLITAN ELECTRONICS & INSTRUMENTS CO.
Dept. F
106 Fifth Ave., New York, N.Y.

LOUD SPEAKING TELEPHONE

Patent No. 2,568,823

Ralph K. Potter, Morristown, N. J.
(Assigned to Bell Telephone Labs., Inc.)

This patent eliminates the need for holding a handset while telephoning. A loud speaker carries the incoming message to the listener, who may be a short distance away. A sensitive microphone picks up and transmits the reply. This leaves the party free to continue his work during a conversation.

The incoming speech is first amplified. It is used to modulate an ultrasonic wave of a frequency of about 30 kc. This carrier may have a power of about 2 watts. Using this high frequency carrier prevents feedback and interference

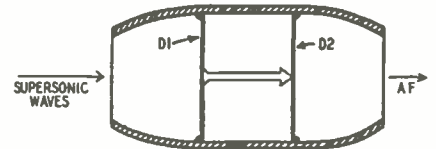

with the outgoing speech. It also preserves the secrecy of the incoming message. However, it makes necessary a special sonic detector. This may be a tiny capsule acoustic rectifier placed in the ear canal of the listener.

One form of sonic converter is shown in the figure. It is about 1 cm long, 0.4 cm in radius and about .04 cm thick. The shell is made of metal or plastic and is open at both ends. There are two diaphragms, D1 and D2. The first resonates at about 30 kc, the second at audio frequencies. A small metal nib extends from D1. When the ultrasonic waves deflect D1 to the right, the nib also sets D2 in motion. Displacement of D1 to the left has no effect on D2. Thus, the capsule constitutes a half-wave sound rectifier. D1 vibrates in accordance with each individual wave of the carrier. The envelope wave or audio modulation is transmitted by D2.

FIRE DETECTOR

Patent No. 2,571,605

Melville F. Peters, E. Orange, N. J.
(Assigned to Petcar Research Corp., Newark)

This is an efficient detector of fire or dangerous high temperature. It uses a bridge circuit, which has a transmission line as two of the arms. The line is run through a storage space, engine room, or other area to be protected. In case of fire, an alarm is flashed or sounded at a manned station.

The schematic is shown in a and its equivalent circuit in b. A, B, and C are three of the bridge arms. The fourth is composed of D and R in series. C and D are the transmission line conductors. These are spaced by beads made of semi-conducting material. At room temperature the

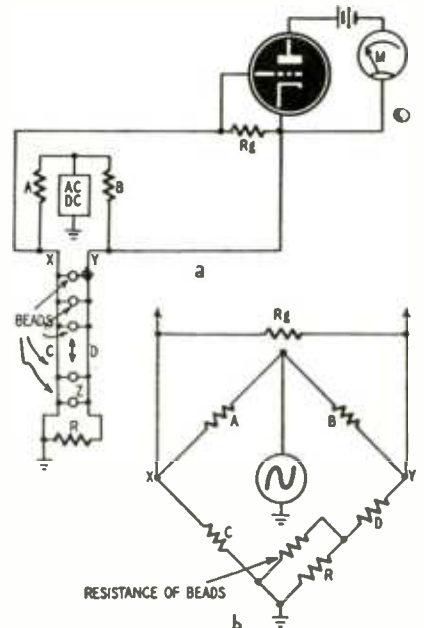

beads have almost infinite resistance. When heated their resistance is very low.

The bridge is balanced at room temperature by adjusting A or B. The bridge power source may be either a.c. or d.c. At balance there is no voltage across grid leak Rg so practically no plate current flows through the tube. The bridge is designed to make the tube grid positive when the RD arm has low resistance.

If a fire should break out, the bead resistance is greatly reduced so the bridge is unbalanced. The tube grid is driven positive and a high plate current flows through M. This may be a meter, relay, warning light, or other control device. It may be used to switch on fire-fighting equipment as well as sounding the alarm.

AUTOMATIC FIRE ALARM

Patent No. 2,566,121

Donald P. Decker, Belmont, Mass.

This patent covers a practical, automatic system for sounding a fire alarm. Transmitters are located in different rooms or areas to be protected. One receiver is needed to intercept the alarm. In case of fire, one or more transmitters send out signals over the electric wiring network

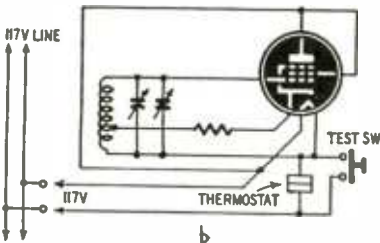
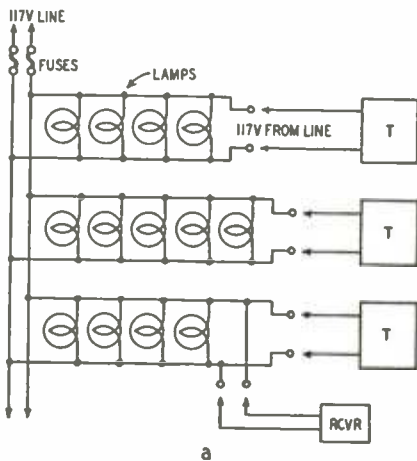

of the building. A typical system of three transmitters and one receiver is shown at a.

The transmitter T is a single tube oscillator as in b. The tube should have a power output of about 1 or 2 watts. Type 117N7-GT (with rectifier elements unused) is suitable. Its filament is connected in series with a thermostat. The circuit absorbs no power until the thermostat closes. This occurs when the ambient temperature climbs to some pre-determined value. Then the circuit oscillates and a signal of about 100 kc is sent out into the wires.

The patent makes no special claim for the receiver as such. It is recommended, however, that a type 0A4-G tube be used so that normally no power is consumed. When a 100-kc signal is intercepted, the tube breaks down and operates a relay. This may ring a bell, flash a light, or operate some other warning device.

—end—

NATIONAL EMERGENCY

If you have any scrap iron, steel, copper, bronze, aluminum, lead, zinc or other metal, turn it over to cooperating scrap-collecting agencies. The defense effort needs it more than you do.

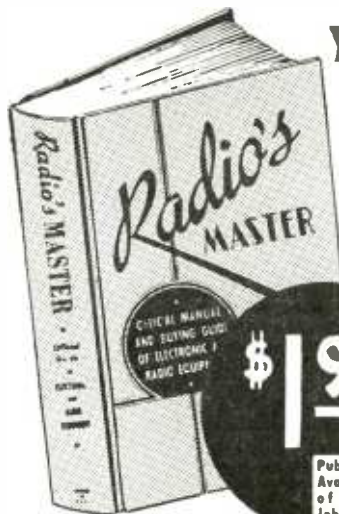

You'll find it
FASTER
in the
MASTER

No More
Files of
Small
Catalogs and
Loose
Literature

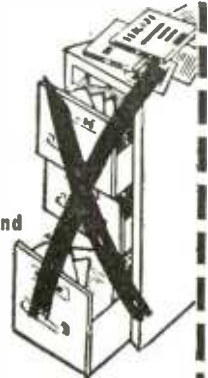

\$1.95

Publisher's price \$6.50.
Available at special price
of \$1.95 thru Parts
Jobbers who absorb part
of cost for privilege of
printing ad on cover.

Industry's OFFICIAL
Buying Guide of Radio-
Electronic-Television
parts and equipment.

When you **BUY--SELL--SPECIFY**
you must have the **MASTER**

This single volume replaces all other small catalogs

Over 90% of the products manufactured in the Radio-Electronic-Television Parts and Equipment Industry are catalogued in this BIG 1100 page MASTER Buying Guide. Complete descriptions, with specifications and illustrations are written and compiled by each manufacturer covering such products as: tubes, instruments, TV parts, transformers, capacitors, resistors, test equipment, relays, coils and antenna equipment. Also, recording and PA systems, intercoms, tools, hardware, switches and thousands of associated products. IT'S YOUR "RADIO BIBLE"—SAVES YOU TIME AND MONEY.

- 1100 Pages
- Hard Cover
- Fully Indexed
- Over 75,000 Items
- Over 7000 illustrations
- Weight—5 lbs.
- Size—8 1/4 x 10 3/4"
- Serving the Industry 16 years

BE MASTER-Minded—GET your copy NOW

UNITED CATALOG PUBLISHERS, INC.
110 Lafayette St., New York 13, N. Y.

NEW — 16th Edition available
from local Parts Distributor at
the special \$1.95 price.

IT'S GOT **everything**
FOR **profitable servicing--**



Your time is money! That's why Clarostat's latest catalog gets right down to what's-what in **CONTROLS and RESISTORS**. Instead of lengthy sales blurb, you get better listings of more values to meet the greatest range yet for servicing and initial-equipment needs. Proved easier, faster, safer and more profitable to work with this latest Clarostat catalog.

Ask for your copy...

Your Clarostat distributor has your copy waiting for you. Ask for it. Or if you prefer, write us directly.



Controls and Resistors
CLAROSTAT MFG. CO., INC., DOVER, NEW HAMPSHIRE

In Canada: Canadian Marconi Co., Ltd., Toronto, Ontario

there is only **1** **JC YAGI**

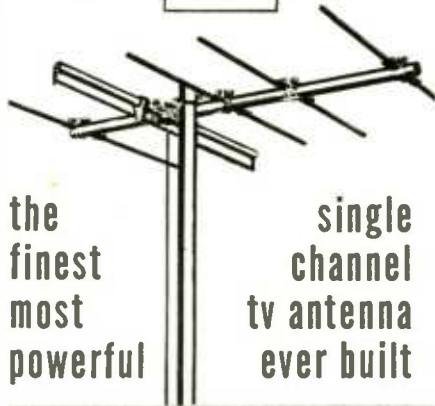

the finest most powerful

single channel tv antenna ever built

FOR SUPERPOWER

INSTALL **JC** STACKED ARRAYS



↑ 4 stacked side-by-side array. Ideal for powerful long distance reception in hilly and mountainous terrain.

4 stacked vertical array. Extremely high gain and excellent signal-to-noise ratio. Ideal for areas with relatively flat terrain.

Double-stacked array with half-wave spacing. Provides added gain and better signal-to-noise ratio.

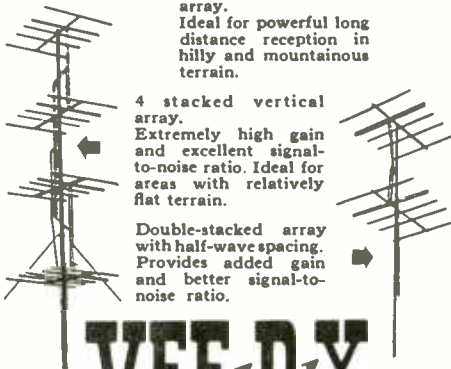

VEE-D-X

The World's Most Powerful TV Antenna Systems

THE LaPOINTE-PLASCOMOLD CORPORATION
Windsor Locks, Connecticut

Gentlemen:
Send me complete technical information on the JC Yagi and its stacked arrays.

Name

Street

City..... Zone..... State.....

Please check Jobber Dealer Technician

HUM REDUCING CIRCUIT

If you have trouble with residual hum in an amplifier with push-pull pentode output tubes, you can probably balance it by making a few slight modifications in the original circuit. The modifications (see diagram) consist of replacing the cathode bias and screen dropping resistors with potentiometers or semi-adjustable units and using separate bypass capacitors on each cathode and screen-grid pin. The cathode resistor and capacitors are shown as R1

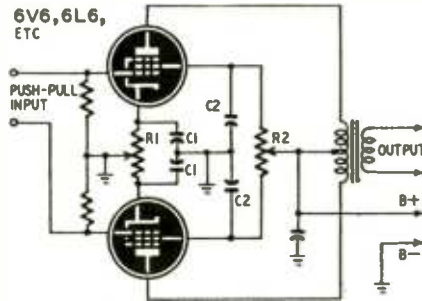

and C1 and those in the screen-grid circuit are shown as R2 and C2. The value of R1 should be twice the resistance of the unit which it replaces. C1 should be as large or larger than the unit used in the original circuit. The screen bypass capacitors C2 should be determined experimentally for different values of R2. Typical values are 25,000 ohms and 0.1 μ f. If there is no screen dropping resistor in the original circuit, use the lowest value of R2 which provides proper operation of the circuit.

Adjust R2 for minimum hum, then balance the plate currents by adjusting the setting of R1. Hum is eliminated or reduced below objectionable levels when R1 and R2 are properly adjusted.—Leon Medler

CAPACITIVE DIVIDER

It is often desirable to use a scope to observe the pulse waveforms present in electronic flash guns, automotive ignition systems, TV flyback power supplies, and similar devices. Since the maximum voltage which can be fed into the amplifiers of the average scope is considerably lower than the amplitude of the pulses which we wish to observe, its field of usefulness is severely limited.

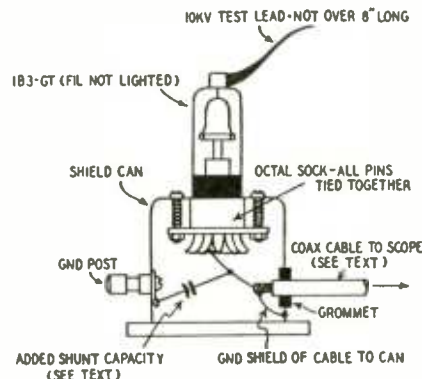

A capacitive voltage divider for reducing pulse amplitudes to levels which can be safely fed into scope amplifiers is described in *Sylvania News*. The unit

TRIAD
General Purpose
POWER
Transformers



Tested... to meet your requirements and excel in performance...

TRIAD general purpose Power Transformers are specially designed, not only for replacement, but for use in electronic equipment for industry, for PA amplifiers, and for amateur gear.

All types are "Climatite" treated, both coil and core, for protection against moisture and for elimination of lamination chatter. Laminations are painted to prevent rust. Although small in size, the high quality materials used in these transformers keep losses to a minimum. Only copper coils for static shields, grounded to case and core, are used. Leads are UL approved for high temperature operation. Final tests include checking for correct operation and stressing in all ways beyond maximum operating potential. Beautifully finished in gray enamel with all specifications on decal on the case.

Remember! Only Triad Transformers are "Climatite" treated

Available from stock at leading jobbers

Write for Catalog
TR-51



2254 So. Sepulveda Blvd.
Los Angeles 64, Calif.

RADIO-ELECTRONICS for

BOTH BOOKS FREE

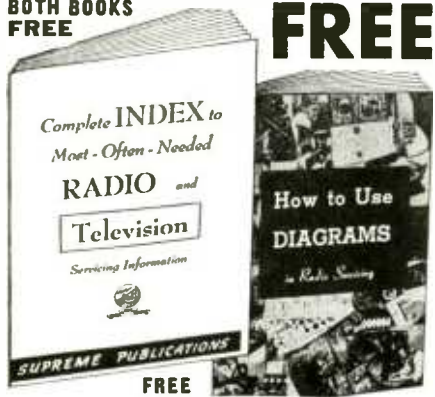

FREE

FREE to every reader of RADIO-ELECTRONICS. No strings, nothing to buy. "How to Use Diagrams" gives hints, suggestions, short cuts on the use of diagrams in radio servicing. The 25-page INDEX will tell you just what models are included in all SUPREME "Most-Often-Needed" Radio or Television manuals. If you need a circuit at any time, this INDEX will tell you where to get it. Get both books in 2-in-1 volume FREE; just send stamp for postage.
SUPREME PUBLICATIONS 3727 W. 13th St. Chicago 23, ILL.

LOW FACTORY PRICES

Sensationally New for 1952!
MIDWEST TELEVISION
 and 5 Wave Band **RADIOS**
 In Beautiful Consoles and Complete Chassis

Mammoth 20-Inch Rectangular PICTURE

Easy to install in your own Cabinet.

30 DAYS TRIAL EASY TERMS

Midwest offers a sensationally new 1952 line of beautiful consoles and complete chassis for easy installation in your own cabinet. Mammoth 20-Inch Television... powerful, world-ranging Radios... at low Factory Prices, and on Easy Terms and 30 Days Trial.

WE PAY TRANSPORTATION CHARGES.

Special Bonus Gift!

Illuminated TELEVISION CLOCK
 Given With Every Purchase of a **MIDWEST RADIO or TELEVISION LIMITED TIME ONLY!**

Phone For **FREE 1952 MIDWEST CATALOG**
 IN NEW YORK Murray Hill 2-6810 IN CHICAGO State 2-5600
 IN CLEVELAND Prospect 1-7450 IN PITTSBURGH Grant 1-0609
 IN DETROIT Woodward 3-1233 IN ST. LOUIS Grand 1161
 IN PHILADELPHIA Locust 4-1035 ... or send coupon below

Buy **DIRECT** from the **MIDWEST Factory** and **SAVE!**

SEND THIS COUPON FOR FREE MIDWEST 1952 Catalog

MIDWEST RADIO & TELEVISION CORP.
 Dept. 387, 909 Broadway, Cincinnati 2, Ohio

NAME _____
 ADDRESS _____
 CITY _____ ZONE _____ STATE _____

consists of two series-connected capacitors with the pulse voltage being applied across the pair and the attenuated output voltage tapped off between the junction of the capacitors and ground. The input voltage divides across the capacitors in inverse proportion to their capacitance.

The divider shown in the drawing consists of a 1B3-GT in series with the capacitance formed by the input capacitance of the scope plus the capacitance of a length of coax used to connect the divider to the scope.

When the scope is a Sylvania 132, 400 or similar model having 26 μf input capacitance, the connecting cable must be 52 1/4 inches of RG-58/U or 71 inches of RG-59/U. Models which have an input capacitance of 34 μf like the Sylvania 400 require 48 3/4 inches of RG-58/U or 66 1/4 inches of RG-59/U. In either case, the input side of the cable must be shunted with a 50- μf capacitor to provide the desired 200 to 1 attenuation ratio.

The capacitive voltage divider should not be used for checking vertical pulses at the plate of the vertical output tube because at 60 cycles, the input capacitance of the divider is not high enough to handle the signals without distortion. Scopes like the 132 and 132Z having input resistances of approximately 500,000 ohms should not be used with the divider when the pulse rate is lower than 15,750 cycles. The divider can be used for pulse rates down to 2 kc with scopes like the model 400 which has an input impedance of about 5 megohms.

ONE-TUBE NBFM ADAPTER

The diagram shows a simple 1-tube narrow-band FM modulator which can be used with the SCR-274-N and ARC-5 command transmitters and units having similar oscillator circuits. BCI and TVI complaints which we received while using plate modulation disappeared when this modulator was substituted. With the component values shown, the

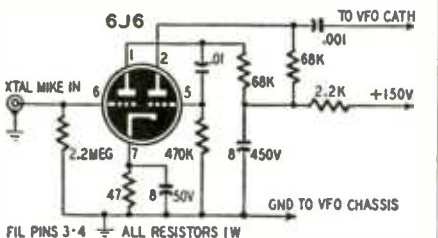

dead spot in the center of the carrier is very narrow so the signal can be received by detuning only slightly from maximum signal strength.

The plate of the output section of the 6J6 feeds into the cathode of oscillators whose cathode is "hot" to r.f. If the oscillator cathode is grounded, the .001- μf coupling capacitor connects to the grid.

Before putting this or any other NBFM exciter on the air, be sure to check the linearity and frequency deviation. Follow the instructions for checking FM and PM transmitters in the ARRL handbook.—Ronald W. Heckbert

USE PHOTOFAC

the world's best Radio and TV Service Data...



WE'LL PROVE YOU'LL SAVE TIME and EARN MORE WITH PHOTOFAC

FREE Service Technicians: We'll send you any Photofact Folder listed in the "PF INDEX and Technical Digest." If you haven't an Index, get a free copy from your local Photofact distributor or write for it today. To obtain Free Folder, be sure to state Photofact Set and Folder Number as shown in the Index.

NOW—learn for yourself how PHOTOFAC makes your Radio and TV work quicker, easier, more profitable! Just get and use an actual PHOTOFAC Folder. Discover why over 35,000 successful service technicians count on this invaluable data daily. No other service gives you PHOTOFAC'S completeness, accuracy, uniformity and lowest cost. PHOTOFAC is the only Radio-TV service data prepared from laboratory analysis on the actual equipment. Get your FREE Folder now. Examine, use, compare. See why you can't afford to be without PHOTOFAC!

NOTE: Our FREE Folder offer is limited to Service Technicians only. Attach coupon below to your letterhead and mention your jobber's name. Experimenters and others may obtain the Photofact Folder by remitting amount shown below.

HOWARD W. SAMS & CO., INC.

HOWARD W. SAMS & CO., INC.
 2201 E. 46th St., Indianapolis 5, Ind.

I am a Service Technician. Send me Free Folder No. which appears in Photofact Set No. (as listed in the PF Index).

I am an Experimenter. Enclosed \$..... Send me Folder No. which appears in Photofact Set No. (TV—\$1.00. AM/FM—50c. Record Changer or Communication Receiver—75c)

Name.....
 Address.....
 City.....Zone.....State.....

EASY PAY PLAN! **PAY AS YOU EARN!** Ask your distributor about this amazing plan. Only \$18.39 puts the entire profit-boosting Photofact library in your shop now!

Simpson model 480 genescope

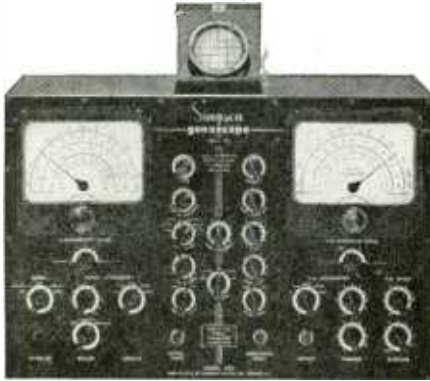

DON ANDERSON
HOFFMAN



NORM COOPER
HALLCRAFTERS



FRANK SMOLEK
ZENITH



MAX SCHINKE
ADMIRAL



FLOYD MAKSTEIN
EMERSON



TIM ALEXANDER
MOTOROLA

RECOMMENDED

by service managers of leading manufacturers

These leading service managers agree the Simpson Model 480 Genescope is THE instrument for accurate testing and alignment of TV and FM receivers.

It provides ALL the necessary signal sources and includes the famous Simpson high sensitivity oscilloscope completely equipped with a high frequency crystal probe for signal tracing. Also available without the oscilloscope as Simpson Model 479 TV-FM Signal Generator. For complete specifications see your Parts Distributor or write SIMPSON ELECTRIC COMPANY, 5200 W. KINZIE ST., CHICAGO 44.

EQUALIZING CRYSTAL PICKUPS

During the last few years we have read so much on equalizing variable-reluctance and similar pickups that many of us have forgotten that equalization also improves the performance of crystal pickups.

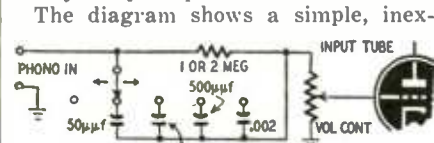

The diagram shows a simple, inexpensive method of equalizing any crystal pickup.

The capacitor values and the number of capacitors used may be varied to suit individual tastes. I find that a 5-position switch with the capacitors shown meets most requirements.—R. C. Sandison

SELF-LOCKING RELAY

Some capacity relays and photoelectric relays sound an alarm or operate an indicator only as long as the pickup device is triggered. When a self-locking circuit is desired, the original relay must be replaced or its circuit modified.

This circuit shows how an inexpensive 12-volt d.c. relay can be added to make the circuit self-locking. Most 12-volt relays will hold in on 6 volts if the armature is depressed manually.

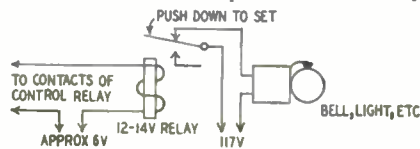

This circuit makes use of this feature. Approximately 6 volts is applied to the coil of the 12-volt relay through contacts on the relay in the control circuit. The alarm circuit is opened by pressing down on the armature. A momentary interruption of the control circuit will release the armature of the 12-volt relay and thereby complete the alarm circuit.

The voltage normally applied to the 12-volt relay should be sufficient to hold the relay closed but not sufficient to operate it. Holding voltage for the relay may be obtained by rectifying the voltage available at a convenient filament transformer and filtering it with a low-voltage electrolytic of 100 µf or more.—O. C. Vidden



Suggested by Marky Burton, Chicago, Ill.

TUBES at Mfr's. COST

Standard Brands—Unbranded—Guaranteed			
*1B3	\$1.75	6BF8	\$5.70
1L4	.60	6BQ6	1.48
*1L5	1.05	6C4	.84
1R5	.80	6BC6	.56
1U4	.80	6CD6G	1.93
1U5	.50	6HG6	.75
*2A3	1.45	*4J5M	.75
*2X2	.80	6J6	.73
3Q4	.86	*6J6	1.09
3V4	.62	*6K6	.85
5U4G	.75	*6J7GT	.85
*5V8	1.20	6L6G	1.05
5Y3GT	.73	6L6CA	1.05
*5Z3	.85	*6R6	1.50
*6AC7	1.25	6S4	.81
GAC5	.57	*6S7M	1.05
*6AG7	1.65	*6SA7	.75
*6AM6	1.75	*6SC7	1.10
6AM5	1.10	*6SJ7	.70
*6AK6	1.10	6SK7GT	.53
6AL5	.44	6SL7GT	.65
6AQ5	.65	*6SN7GT	.75
6AT5	.40	6T8	.65
6AU6	.65	6V6GT	.91
*6AV6	.65	6W4GT	.49
*6AB5	1.25	6X4	.36
6BC5	.48	6X5	.36
6BE5	.56	*7A07	1.25
6BE6	.49		.89
			.75

UNBRANDED—*STANDARD BRANDS
Minimum Order \$15.00

SPECIAL PURPOSE TUBES

1236	\$9.95	703A	\$2.45	9002	\$1.50
1N23A	7.75	807	1.10	9003	1.75
1N23B	7.75	813	7.50	9005	1.75
2E25	7.95	832	7.50	CK78	4.95
304TL	10.50	837	1.25	RR73	1.50
304TH	10.50	866	1.45	T20	2.25
3B24	5.50	931A	6.75	VR105	1.15
75TH	6.75	5670	5.95	VR150	1.00
211	.95	5814	4.95	TU120	3.95
350B	5.50	8025	5.75	TZ20	2.25
394A	5.50	9001	1.75	TZ40	3.25

IMMEDIATE DELIVERY!
Write for quotations, many other types available. 30% deposit with order, balance C.O.D. All tubes subject to prior sale. Prices subject to change without notice.
WRITE, WIRE, CALL—TODAY!
We Buy Anything in Electronics—large or small Quantities!

Nat Adelman
168 Washington St. New York 5, N. Y.
CO. 7-5391

REK-O-KUT presents a New
Continuously Variable-Speed Turntable of Broadcast Quality



Plays at any speed from 25 to 100 R. P. M., without "wow!"

Speed can be varied while in operation to produce sound effects.

Now for the first time . . . a continuously variable turntable of Broadcast Quality at a popular price. Ideal for record collectors, musicians, singers, disc jockeys, broadcast stations, music schools, dance studios, skating rinks, gymnasiums, etc. Plays through amplifier, radio, TV set or phonograph. Operates on 50 or 60 cycles.

Model CVS-12 (illustrated)
Chassis, motor and turntable . . . \$84.95 net.
Model CVS-12P, mounted in portable case with 16" dual stylus pickup . . . \$124.95. net.

3-Speed 12" Transcription Turntable
Recommended by outstanding music critics. Induction-type motor designed for smooth, quiet, vibration-free operation. 3 speeds, 78, 45 and 33 1/3.
Model LP-743 . . . \$54.95 net.

Write for Illustrated Catalog of REK-O-KUT Line of Hi-Fidelity Recording Instruments, Phonographs, Transcription Tables, Accessories.

REK-O-KUT CO.
38-11 A Queens Blvd., L.I.C., N. Y.

RADIO-ELECTRONICS for

JERCS PROPOSE PANEL

The Joint Electronics and Radio Committee on Service (JERCS) a group representing various TV and radio servicing interests in Philadelphia, has proposed a Technical Education Advisory Panel composed of service managers of contractors, dealers and distributors in Philadelphia. The panel would meet regularly to discuss and prepare recommendations for the technical education of the service industry. The recommendations would be compiled and submitted to the local distributors for their use in combination with their current educational programs.

Nomination blanks for the first panel—which was to be composed of 15 members—were sent out to all Philadelphia TV contractors, distributors and dealers with service departments.

FRSAP ELECTS OFFICERS

The Federation of Radio Servicemen's Associations of Pennsylvania elected the following officers for 1952:

Dave Krantz, Philadelphia Radio Servicemen's Association, chairman; Milan Krupa, Luzerne County Radio Servicemen's Association, chairman; man; Leon Halk, Lackawanna Radio and Television Servicemen's Association, secretary; and F. J. Schmidt, Mid-State Radio Servicemen's Association, treasurer.

The Philadelphia association's publication, *P.R.S.M.A. News*, was adopted as the official organ of the Federation and will in the future be sent to all members of affiliated chapters.

WINTHROP HARBOR MEETS

Radio Technicians of Winthrop Harbor, Ill., organized a special meeting to hear Frank Moch, president of The National Alliance of Television and Electronic Service Associations (NATESA) Martin C. Reese, treasurer of the Chicago Television Installation and Service Association (TISA) and Mal Parks, Jr., discuss present service problems.

Officers of the Winthrop Harbor group are Walter Hieber, Jr., president; Charles Putkus, vice president; and Bill Rupnick, secretary-treasurer.

FEE STAYS HIGH

Supervisors of Los Angeles County have refused to lower the \$36 license fee imposed annually on all television repair shops in the unincorporated portions of Los Angeles County. The high fee had been protested by a number of groups, including the Electric League of Los Angeles. Managing director Glen L. Logan of the League pointed out that \$36 per year might cause hardship to many small operators, and asked that the fee be reduced to \$18.

TECHNICIANS' BLOOD BANK

The Radio and Television Technicians Guild of Florida has started a blood bank for its members. Donating members may use the bank for their immediate families if the need ever arises. A portion of each donation goes to the armed forces.

—end—



**ELECTRONICS TECHNICIANS
ELECTRICAL DRAFTSMEN**

**CONVAIR IN SUNNY SAN DIEGO,
CALIFORNIA, INVITES YOU....**

—to accept a position now in the modern, progressive Convair Engineering Department and live in beautiful San Diego, California—land of sunny Winters and blanket-cool Summers.

Yes, Convair (Consolidated Vultee Aircraft Corporation) will pay your moving and travel expenses to a good job if you are a trained Electronics Technician or Electrical Draftsman. Aircraft experience a help but not necessary.

WORKING FACTS: You get two holidays a week at Convair—overtime accomplished in 5-day week. Attractive salary ranges. Interesting, challenging, essential, long-range projects of a wide variety, including — commercial aircraft, military aircraft, missiles, engineering research and electronic development. Excellent patent royalty arrangements. Top-notch retirement plan — better-than-average life and health insurance. Complete progress-salary review for each person twice yearly. Opportunity for continuing engineering education.

**MAIL THIS COUPON NOW
FOR FREE BROCHURE GIVING
COMPLETE DETAILS
AND APPLICATION FORM.**



THANK YOU
Mr. H. T. Brooks, Engineering Department
Convair, 3302 Pacific Hiway, San Diego, California

My name _____
Occupation _____
Address _____
City _____ State _____

★ **WANTED** WE NEED YOUR ★
★ SURPLUS ★
★ ELECTRONIC ★
★ EQUIPMENT ★

★ **WE PAY TOP \$\$\$ FOR:** ★

★ RADIO RECEIVERS	★ CLAMPS
★ TRANSMITTERS	★ PLUGS
★ ARC-1	★ CORDS
★ ARC-3	★ RELAYS
★ ART-13	★ TELEPHONE
★ CONTROL BOXES	★ MATERIALS
★ INDICATORS	
★ AN CONNECTORS	

★ **WE BUY ANYTHING!!** ★

★ Write, Wire Today! ★
★ Tell us what you have ★

★ **TALLEN COMPANY, INC.** ★
★ Dept. RE, 159 Carlton Ave. ★
★ Brooklyn 5, New York ★

**WANTED
TO BUY**

Large and small quantities of new or used electronic government or manufacturers' surplus tubes and equipment. Highest prices paid. State quantity, condition and best price in first letter.

Box No. F-2 c/o Radio-Electronics
25 West Broadway
New York 7, N. Y.

3 New Custom-Built Deluxe TV Chassis

by **TECH-MASTER**

MODEL 2430—Designed specifically for all picture tubes requiring from 65 to 70 degrees horizontal deflection, (such as 24AP4, 20CP4, 19AP4, etc.) Supplied with quality PM speaker, and Universal Picture Tube Mounting Brackets & Phono Jack. **\$189.50**

MODEL 2431P—Similar to model 2430, but with Push-Pull Audio, True Fidelity Output and Universal Picture Tube Mounting Brackets. **\$199.95**

MODEL 2431C—Basically same as Model 2430 but with Continuous Tuner, Push-Pull Audio, True Fidelity Output and Universal Picture Tube Mounting Brackets. Allows complete coverage of both TV and F.M. bands. **\$199.95**

The new Gold Medal Series incorporates all the latest Tech-Master features which have made this improved 630 type chassis the standard by which custom-built TV is measured... performance and service are assured because Tech-Master design and construction are as fine as human hands and brains can produce. All chassis are supplied completely wired, aligned and tested with all tubes (less picture tube).

LOOK for your Tech-Master registration and guarantee card attached to each chassis... it is your assurance that you are buying a genuine Tech-Master receiver.

See the Gold Medal Series and other quality Tech-Master products at your favorite Radio Parts Jobber or write direct to Tech-Master Products Co. Dept. RE-2 for complete descriptive literature.

TECH-MASTER PRODUCTS CO.
443-445 Broadway * New York 13, N. Y.

ADAPTER FOR CRYSTALS

Many of the prewar transmitting crystals were mounted in holders which fitted into the old five-prong sockets. Thus the pins are too large to fit into an octal socket or one of the newer type crystal sockets. I use these crystals in standard sockets by using ordinary phone tips as adapters as shown in the drawing. The pins on the holder fit tightly into the open ends of the phone tips, and the small ends of the tips fit snugly into the holes in the modern octal and standard crystal sockets.—Joseph Zukauskas

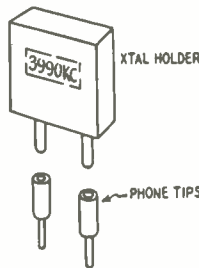

SUPPLEMENTARY BEAM ADJUSTER

When you have trouble centering a TV picture sufficiently to fit the screen, try moving a small permanent magnet around the neck of the picture tube—preferably between the yoke and focus coil or focalizer. When the picture is properly centered, carefully tape the magnet in place.—Alfred Huntington

(Caution: Be careful when trying this on a metal tube. There is danger of permanently magnetizing an area of cone with the result that the picture may be severely distorted. Use care when making the adjustments. Any change in the strength or position of the normal magnetic fields of the focus coil or deflection yoke may have a decided effect on the operation of the ion trap. Make the initial adjustments with the brightness turned down low. After centering the picture, readjust the ion-trap magnet for the brightest raster. As an aid in eliminating neck shadows this measure supplements rotation of the picture tube, and the usual yoke and focus coil adjustment.—Editor)

PROTECTING INSTRUMENT PANELS

The panels of kits and home-made receivers, transmitters, test equipment, etc. are likely to be scratched or damaged during wiring, assembly, or repair operations. To avoid this, I fasten 1-inch long hexagonal posts to the corners of the panel as shown in the drawing. The posts act as legs and prevent the panel from being scratched by metal filings or a rough surface on the workbench.—M. B. Barnes

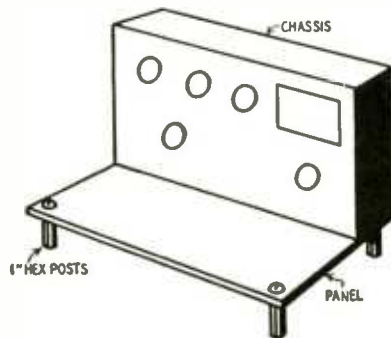

RADIO-ELECTRONICS for

\$3.00 FOR CARTOON IDEAS

RADIO-ELECTRONICS prints several radio cartoons every month. Readers are invited to contribute humorous radio ideas which can be used in cartoon form. It is not necessary that you draw a sketch, unless you wish.

Address:
RADIO CARTOONS, RADIO-ELECTRONICS
25 West Broadway, New York 7, N. Y.

EVERY RADIOMAN Can Use These SERVICE HINTS!

Valuable Manual Yours—FREE!

Every page of "How to Simplify Radio Repairs" is packed with on-the-bench, practical ideas. Contains photos, charts, diagrams—no fluff—no vague theory. In plain every-day language it gives you priceless suggestions—new servicing ideas. You'll use and benefit from the experience of experts. Partial list of contents: How to Localize Trouble; How to Service Amplifiers; How to Test for Distortion; How to Test Audio Circuits; How to Test Speakers; How to Find Faults in Oscillators; How to Test Radio Parts—and it's all yours—FREE! No obligation.

FEILER SEND COUPON OR PENNY POSTCARD FOR YOUR FREE COPY TODAY!

FEILER ENGINEERING CO., Dept. 2RC2
8026 N. Monticello Ave.,
Skokie, Ill. (Suburb of Chicago)

Please RUSH my FREE copy of "How to Simplify Radio Repairs."

Name.....
Address.....
City..... Zone..... State.....

ANNOUNCING...

Our New New Ham Dept. Featuring:—

SONAR MOBILE SR-9 Rcvr

Your choice of 2, 6, 10 meters and commercial frequencies, AM and FM. **\$72.45**

built-in automatic noise limiter, voltage regulated oscillator, precision slide rule dial.

Indispensable when you must hear what's coming through. In mobile or fixed operation, CB, 'CAI' or emergency activity. More than a monitor, more than a converter —It's a 9-tube super-het receiver with over-all sensitivity better than 1.0 micro-volt. Tiny—only 4-9/16" high, 5-3/16" wide, and 5-11/16" deep. Yet SR-9 gives you

SONAR MOBILE MB-26 Xmtr

Like SR-9 Rcvr., this crystal-controlled 6-tube Xmtr goes everywhere. fits anywhere, employs latest v.h.f. techniques! Lets you send clear signal, no matter how gruelling the going. Output: 6 watts. Power consumption: equivalent to car bright lights. Just 6 1/2" high, 7" wide, 5 3/4" deep. Built-in antenna relay system, power filter network. Low maintenance—standard tubes. Power and antenna coax connectors on front panel. **\$72.45**

8 or 24 Mc. crystal, overtone type. Screw-driver adjusted tuning control.

Send for Add'l Info.

Send M.O. or CHK. Mdse. Guard. Shpg. Charges Sent C.O.D. Price F.O.B. N.Y.C. Phone DI. 9-4124

COMMUNICATIONS EQUIPMENT CO.
131 Liberty St. Dept. C-2 New York City 7, N. Y.

PUSH-ON TEST LEAD CLIP

The conventional alligator clip is handy for making temporary circuit connections; however, its comparatively large area of bare metal is a liability when it is pushed into an under-chassis maze of wire and components. I make tiny insulated test clips from the smallest bobby pins available at the local Five and Ten. When completed, the clip is well insulated with only about 1/4 inch of bare metal left exposed at the tip.

Select pins about 1 1/2 inches long and snip off the ends leaving the loop and two corrugated ridges as shown at a. Remove the lacquer with emery cloth, tin the loop and solder a test lead to it. Wrap the loop tightly with sewing thread secured with a drop of service cement. See drawing at b. Flare the tips slightly so they can be pushed over bare leads. Coat the loop and thread heavily with liquid solder and shape it to the diameter of the test lead before it dries.

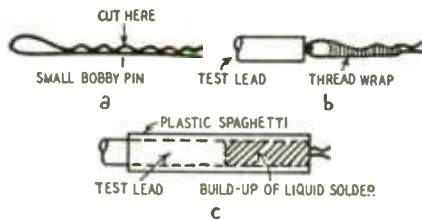

When the solder has dried hard, select a 2-inch length of plastic spaghetti the same color and slightly smaller than the diameter of the test lead. Soak it in service cement solvent until it has swelled to twice its original size. Remove it from the solvent and slide it over the clip and test lead, letting about 1/16 inch extend beyond the tip. When the spaghetti dries, it shrinks to its normal length and diameter making a snug-fitting insulating sleeve which leaves only the business end of the clip exposed. The finished lead is shown in the drawing at c.

Leads tipped in this manner will prove useful for connecting signal tracers, test oscillators, output meters, scopes, and other devices to the circuits under test while leaving both hands free for circuit adjustments.—Van H. Ferguson

SHIELDING KINK

Shielded wiring is often needed in certain parts of electronic circuits to eliminate hum pick-up, feedback, stray coupling, etc. When circuit performance indicates that additional shielding is needed, we usually remove the leads one at a time and replace them with shielded braid until the trouble disappears.

In such cases, you can quickly locate the lead which requires shielding by wrapping tin-foil tightly around the leads suspected of causing the trouble and connecting one end of the foil to ground. If this makeshift shielding improves the performance, it can be replaced with a piece of shielding braid.—O. C. Vidden

WORLD'S FASTEST SELLING VOLT-OHM MILLIAMMETER



Sensitivity
1000 ohms per volt

- ★ Uses latest design 2% accurate 1 Mil. D'Arsonval type meter.
- ★ Same zero adjustment holds for both resistance ranges. It is not necessary to readjust when switching from one resistance range to another. This is an important time-saving feature never before included in a V.O.M. in this price range.
- ★ Housed in round-cornered, molded case.
- ★ Beautiful black etched panel. Depressed letters filled with permanent white, insures long-life even with constant use.

The Model 770 comes complete with self-contained batteries, test leads and all operating instructions. **\$14.90 NET**

- Specifications:**
- 6 A.C. VOLTAGE RANGES: 0-15/30/150/300/1500/3000 Volts.
 - 6 D.C. VOLTAGE RANGES: 0-7.5/15/75/150/750/1500 Volts.
 - 4 D.C. CURRENT RANGES: 0-1.5/15/150 MA. 0-1.5 Amps.
 - 2 RESISTANCE RANGES: 0-500 Ohms 0-1 Megohm.

Model 770
is an accurate pocket-size V.O.M.
Measures only 3 1/4" x 5 7/8" x 2 1/4"

Write Dept. RC-2 for catalog of complete line.

SICO Manufactured and Guaranteed by
SUPERIOR INSTRUMENTS CO.
227 Fulton Street • New York 7, N. Y.

AT YOUR RADIO PARTS JOBBER

The Largest Selling LIGHTNING ARRESTER At Any Price!

NO. AT102
UL APPROVED

JFD JUMBO

Protects Home and TV Set Against Lightning Hazards **\$2.25 LIST**
U.S. Patent No. D-4664

- Installs anywhere
- No wire stripping, cutting or splicing

(Complete with strap and ground wire.)
OVER 1,000,000 IN USE TODAY!
See Your Jobber or Write for Form No. 84

JFD MANUFACTURING CO., Inc.
61018 10th Avenue, Brooklyn 4, N. Y.
DEPT. 10 For Television Advances and Accessories

SHOOT TV TROUBLE FAST!

With H. G. Cisin's Copyrighted **RAPID "TV TROUBLE SHOOTING METHOD"**

Without experience or knowledge, this guaranteed new method of servicing TV sets enables you to DIAGNOSE TV troubles as rapidly as an expert. **NO THEORY—NO MATH**—you can locate all faults in record-breaking time, regardless of make or model.

"TV TROUBLE SHOOTING METHOD" is the most valuable aid to TV servicing ever written. Be a TV Trouble Diagnostician, increase your present earnings, open your own profitable business or get a high-paying skilled job.

It's all in this book... Nothing more to pay—Nothing else to buy

Alphabetically listed, there are 85 picture troubles, over 38 raster and 17 sound troubles and by this unique copyrighted method you know EXACTLY WHERE the trouble is; plus step-by-step instructions, including 69 RAPID CHECKS, enabling you to find the faulty part.

13 IMPORTANT PRELIMINARY CHECKS NEED NO INSTRUMENTS! Of the 69 Rapid Checks, OVER 65 ALSO REQUIRE NO INSTRUMENTS! Rapid checks include emergency checks for distorted pictures, defective tubes including PIX tube, plus 57 others. **ALL EXPLAINED IN SIMPLE LANGUAGE. PERFORMED WITHOUT INSTRUMENTS. MANY CHECKS USE THE PICTURE TUBE AS A GUIDE.**

H. G. Cisin, the author, is the inventor of the AC/DC midjet radio. He licenses RCA, AT&T, etc. He has also trained thousands of technicians now owning their own prosperous TV service organizations or holding highly paid TV positions. His years of experience are embodied in this remarkable new TV TROUBLE SHOOTING METHOD.

Guaranteed, Money Back in 5 Days if Not Satisfied! Send your name and address to-day with \$1 for your postpaid copy: you'll say it's worth hundreds!

RUSH COUPON NOW!

H. G. CISIN, CONSULTING ENGINEER, (Dept. E-10)
200 Clinton Street, Brooklyn 2, N. Y.

Name.....
Address.....
City..... Zone..... State.....

Compare!
PROVE
EMC
SUPERIORITY!



MODEL 106
Vacuum Tube Voltmeter
✓CHECK THESE FEATURES

Specially designed for field alignment of television and radio sets. Uses dual triode balanced bridge circuit. All functions and ranges completely electronic—meter cannot burn out. Zero center position for FM discriminator alignment. Uses 1% precision resistors for voltage multipliers. 5 DB ranges. Full scale deflection of 1½ volts for both AC-DC volts. Measures resistance in 5 ranges from .2 ohm to 1000 megs. 1 ME isolating resistor in probe.

SPECIFICATIONS
DC VOLTAGE: Input resistance 16.5 megs or 1½ megohms per volt. Ranges: 0 to 1.5, 10, 100, 300, 1000 up to 30,000 volts (with accessory probe).
AC VOLTAGE: Input resistance 2 megohms. Ranges 0 to 1.5, 10, 100, 300, 1000. Frequency response flat from: 25-100,000 cycles.
OHMS: 1000—10,000—100,000—10 megohms, 1000 megohms.
Compact, portable bakelite case measures 4¼" x 5¼" x 2⅞".

MODEL 106..... \$35.90
In Kit form..... \$23.90
MODEL MVP 30,000 Volt Probe for Model 106.... \$8.75

Write Dep't RE-2 for latest FREE Catalog.
SEE COMPLETE LINE AT YOUR JOBBERS.

EMC
Electronic Measurements Corp.
280 Lafayette St., New York
Export Dept., 302 N. 47th St., N. Y. C.

CODE SENDING
RECEIVING SPEED



Be a "key" man. Learn how to send and receive messages in code by telegraph and radio. Commerce needs thousands of men for jobs. Good pay, adventure, interesting work. Learn at home quickly through famous Candler System. Qualify for Amateur or Commercial License. Write for FREE BOOK.
CANDLER SYSTEM CO.
Dept. S-B, Box 928, Denver 1, Colo., U.S.A.

ON THE SPOT BATTERY RECORDER

WALKIE-RECORDALL 8 lb. miniature BATTERY RECORDER-PLAYBACK
Continuous, permanent, accurate, indexed recording at only 5c per hr. Instantaneous, permanent playback. Picks up sound up to 60 ft. Records conferences, lectures, dictation, 2-way phone & sales talks; while walking, riding or flying. Records in closed briefcase with "hidden mike!" Write for details.

MILES REPRODUCER CO., INC.
812 BROADWAY Dep't RE-2 NEW YORK 3, N. Y.

MINIATURE TUBE CONVERTER FOR 2466 KC AUTO RADIO

? I would like to have a diagram of a converter to enable me to receive 2466-kc transmissions on an automobile receiver. I would like to have a stage of r.f. ahead of the converter tube and want to use miniature tubes and commercial coils. The converter is to work into the receiver on 1480 kc.—H. H. K., San Francisco, Calif.

A. The circuit is shown. Space can be saved by using fixed capacitors with small trimmers across them instead of the usual tuning capacitors. A 15- μ f

air trimmer is mounted in the oscillator circuit and brought out to the front of the unit to peak the station and to permit compensating for drift.

The antenna, r.f., and oscillator coils and the converter transformer may be types made by the J. W. Miller Co. The type numbers for the coils are B-121-A, B-121-RF, and B-121-C, for antenna, r.f., and oscillator respectively. The converter transformer is a type 512-WT. Equivalent components by other manufacturers will work equally well.

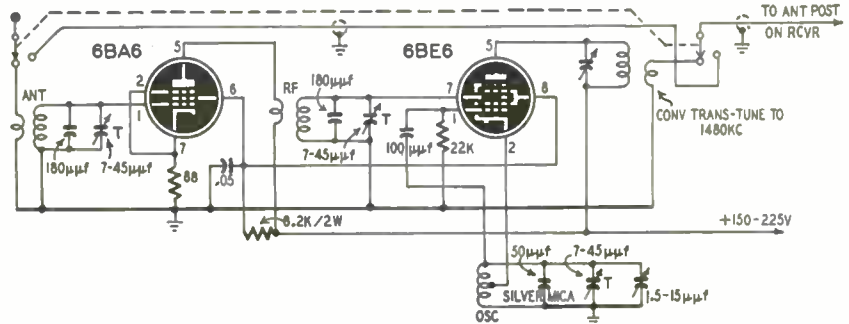

HIGH-GAIN PUSH-PULL 8-WATT 6N6-G AMPLIFIER

? Please print a diagram of an audio amplifier using push-pull 6N6-G's in the output stage. I want to use it with a radio tuner and a record player. Please provide separate input circuits and dual tone controls.—J. W. L., Wayne, W. Va.

A. The diagram is shown. The gain of

the 6SJ7 stage should be sufficient to overcome the losses in the tone controls and still provide enough voltage to drive the amplifier to about 8 watts output. The output transformer should have a primary impedance of 10,000 ohms plate-to-plate and a wattage rating of at least 10 watts.

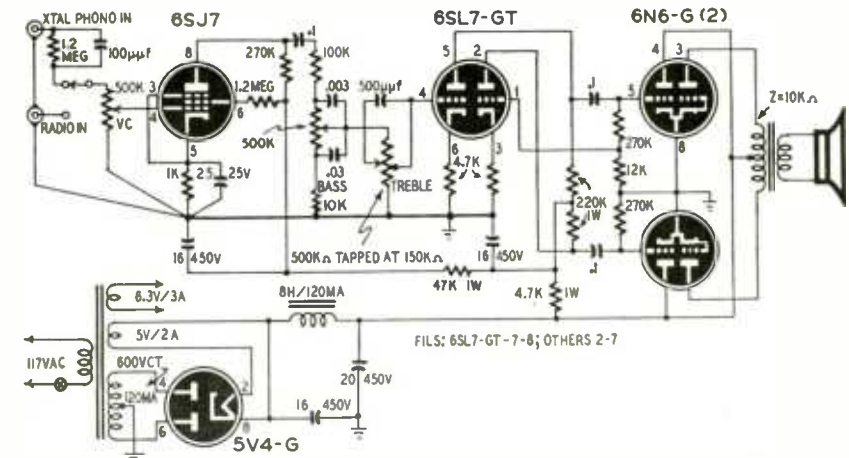

PHOTOTUBE FOR SOUND MOVIE AMPLIFIER

? I have a Newcomb model KX-30 amplifier which I would like to use with my sound-movie projector. Please draw a diagram showing how a GL-868/PJ-2 phototube can be added to this circuit.—T. J. A., Waterbury, Conn.

A. The drawing shows how the phototube can be installed in the grid circuit of the 6J7 mixer stage. The load resistor for the phototube should be of a value which provides maximum output with minimum distortion. Try various values between 1 and 4 megohms. A 50,000-ohm, 10-watt voltage divider is connected between B-plus and ground. Its tap is adjusted for about 75 and not

more than 90 volts on the anode of the PJ-23.

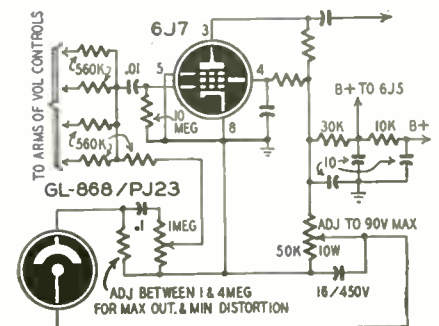

7 HARD TO GET ITEMS AT BIG SAVINGS TO YOU

AMAZING BLACK LIGHT



250-watt ultra-violet light source. Makes fluorescent articles glow in the dark. Fits any lamp socket. For experimenting, entertaining, unusual lighting effects. Ship. wt. 2 lbs. **ITEM NO. 87 A SAVING AT \$2.45**

POWERFUL ALL PURPOSE MOTOR



Sturdy shaded pole A.C. induction motor. 15 watts, 3000 rpm. 3"x2"x1 1/4"; 4 mounting studs; 7/8" shaft, 3/16" diameter; 110-120 volts, 50-60 cycles. A.C. only. When geared down, this unit can operate an 18" turntable with a 200 lb. dead weight. Use it for fans, displays, timers and other purposes. Ship. wt. 2 lbs. **ITEM NO. 147 UNUSUAL BUY \$2.45**

WATTHOUR METER

Leading makes—completely overhauled, ready for service. 100-110 volts, 60 cycles, 2-wire A.C. 5 amp. Heavy metal case 8 1/2" x 6 1/4" x 5". Easy to install. Ship. wt. 14 lbs. **ITEM NO. 33 NOW ONLY \$4.50**



WESTERN ELECTRIC BREAST MIKE

Lightweight 1 lb. carbon microphone. Aircraft type. Breastplate mounting, adjustable 2-way swivel. Easily fastened straps. For home broadcasts, communications etc. Complete with 6 foot cord, hard rubber plug. Sheradized plate, non-rusting finish. Ship. wt. 2 lbs. **ITEM NO. 152 NEW LOW PRICE \$1.75**

TELEPHONE TRANSMITTERS

Genuine transmitters made by Kellogg Western Electric, Stromberg Carlson. Work on two dry cells. For P.A. systems, intercoms, other practical uses. Shipping weight 1 lb. **ITEM 160 REAL VALUE \$2.45**



250 POWER TELESCOPE LENS KIT

Make your own high powered 6 ft. telescopic kit contains 3" diam., .75" focal length, ground and polished objective lens and necessary eye pieces. Magnifies 50x to 250x. Full instructions. Ship. wt. 1 lb. **ITEM NO. 123 YOU SAVE AT \$2.95**



HUDSON SPECIALTIES CO.
40 West Broadway, Dept. RE-2-52
New York 7, N. Y.

I am enclosing full remittance for items circled below. (Be sure to include shipping charges.)

OR, my deposit of \$..... Ship balance C.O.D. MINIMUM C.O.D. ORDER \$5.00.

C.O.D. ORDERS ACCEPTED ONLY WITH 20% DEPOSIT INCLUDE SHIPPING CHARGES.

Circle Items Wanted

87	147	33	152	160	123
----	-----	----	-----	-----	-----

Name..... Please Print Clearly

Address.....

City..... Zone..... State.....

RADIO ENGINEERING DEGREE IN 27 MONTHS

Intensive, specialized course including strong basis in mathematics and electrical engineering, advanced radio theory and design, television. Modern lab. Low tuition. Self-help opportunities. Also 27-month courses in Aeronautical, Chemical, Civil, Electrical and Mechanical Engineering. Approved for G.I.'s. Enter: March, June, Sept., Dec. Catalogue.

INDIANA TECHNICAL COLLEGE
152 E. Washington Blvd., Fort Wayne 2, Indiana

If the amplifier will not deliver full output when used with the phototube, insert a 6C5 or similar voltage-amplifier triode between the 0.1- μ f capacitor at the PJ-23 cathode and the 1-megohm volume control.

PARTS FOR PHONE PATCH

? A basic circuit of a phone patch was shown in the review of patent No. 2,511,948 in the December, 1950, issue. Values of resistors and capacitors were not given. Can you supply them?—*J. V. O., Patchogue, N. Y.*

A. The circuit is reprinted here with experimental values. Experiment with

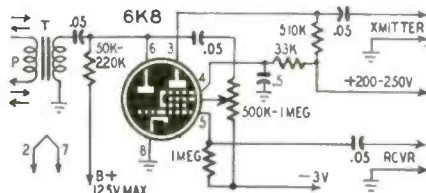

the values of the triode plate and hexode screen resistors, and with the value of the bias voltage. Line transformer T may be an input transformer designed to match a low-impedance line to a single grid or an output transformer which matches the plate of a single voltage-amplifier triode to a line. In either case, the low-impedance winding should be tapped so it can be adjusted for optimum match to the line.

TV CONVERSION

? I would like to install a 17BP4 rectangular tube in a receiver designed for a 16LP4 round tube. What changes will I have to make?—*W. M., Granite City, Ill.*

A. We cannot see the advantages of using a 17-inch rectangular tube in place of the 16-inch tube for which the set was designed. If the picture is properly proportioned, the 16LP4 produces a picture 10 1/4 x 14 1/2 inches. The picture size on a 17BP4 is approximately 10 3/4 x 14 1/4 inches. The increase in size would be imperceptible.

The 16LP4 has a deflection angle of 52 degrees while the 17BP4 has a horizontal deflection angle of approximately 65 degrees. The typical operating conditions are similar for both tubes although the 17BP4 can be operated with somewhat higher second-anode voltages.

To make the substitution, you will have to replace the horizontal output transformer, deflection yoke, and ion trap. The cradle will have to be altered or replaced and you may have to modify the horizontal sweep circuit to obtain sufficient sweep voltage. There would seem to be no advantages to weigh against these difficulties.

CORNER SPEAKER ENCLOSURE

? Please print construction details on a Klipsch-type enclosure for a tweeter, woofer, and a medium-range speaker.—*E. E. B., Pittsburgh, Penna.*

A. Klipsch corner enclosures are fully protected by patents and we have not been able to find enough practical design data to supply you with all the

free send for it

212-PAGE

ALLIED Catalog

the only complete up-to-date catalog for Everything in Radio, Television & Industrial Electronics

Send for the Buying Guide that's used daily by thousands of service technicians, engineers, Amateurs, sound men, builders and experimenters. Make your selections from the world's largest stocks of quality equipment—at lowest money-saving prices. Get every buying advantage at ALLIED—speedy delivery, expert personal help, and complete satisfaction on every order. Make ALLIED your single, dependable source for electronic supplies.

SEND FOR FREE CATALOG

ALLIED RADIO

ALLIED RADIO CORP., Dept. 2-BB-2
833 W. Jackson Blvd., Chicago 7, Ill.

Send FREE 212-Page ALLIED Catalog

Name.....

Address.....

City.....

Zone..... State.....

more than
80,000
RCP Multitesters
MODEL 447B and prototypes
in use
**ALL OVER
THE WORLD**



\$17.95
**SUCH POPULARITY
MUST BE DESERVED!**

The exceptional value of the 447B Model is made possible by the tremendous quantities produced. The resulting very low price is quite reasonable for its great popularity. These units are in a class with other makes of testers that sell for considerably more.

A 3" square D'Arsonval meter is used, having an accuracy of 2%. Accuracy of AC voltage measurements is improved by use of a new gold plated copper oxide rectifier.

RANGES
DC Voltmeter: 0-5-50-250-500-2500 Volts.
AC Voltmeter: 0-10-100-500-1000 Volts.
Output Voltmeter: 0-10-100-500-1000 Volts.
DC Milliammeter: 0-1-10-100-1000 M.A.
DC Ammeter: 0-1-10 Amperes.
Ohmmeter: 0-10,000 Ohms-1 Megohm-10 Megohms Ext.
Decibel Meter: -8 to +55 decibels.

MODEL 447B—Open face, oak case. Size 5"x 8 1/2"x3". Weight 21 oz. Complete with **\$17.95** batteries. Price

MODEL 447BP—Portable, oak case with carrying handle, cover and test leads. Size 6 1/2"x8 1/2"x4 1/2". Weight 24 oz. Complete with batteries. **\$21.95** Price

KITS

NOW ALSO AVAILABLE IN KIT FORM the best professional test equipment made by RCP—precision equipment at the lowest prices ever. Each KIT contains simple step-by-step instructions.

MODEL 447BK—Open face, same \$13.95 as 447B but in kit form

MODEL 447BPK—Portable, same \$16.95 as 447BP but in kit form

Buy from your jobber. Insist on R.C.P. Instruments. Write for Catalog RE-2

RADIO CITY PRODUCTS CO., INC.
152 West 25th St. New York 1, N. Y.

details which you require. Until sufficient data is available, we suggest that you settle for the folded-horn corner enclosure design supplied by University Loudspeakers, Inc.

The enclosure shown was designed for two 4402 dual tweeters, a Cobra-12 wide-angle paging-type radiator, and a pair of 12-inch wide-range speakers as woofers. The speaker cutouts can be altered to handle the speakers which you have.

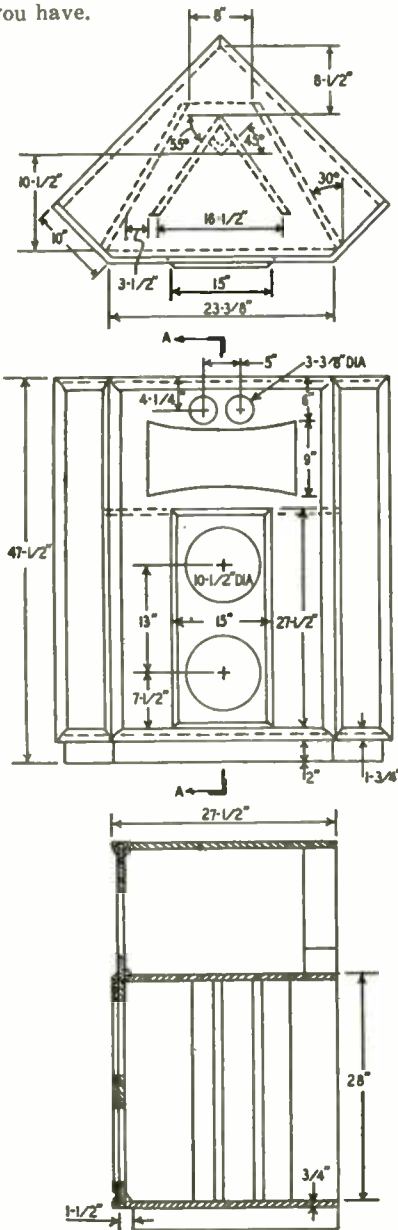

SECTION "A-A"
ALL MATERIAL 3/4"

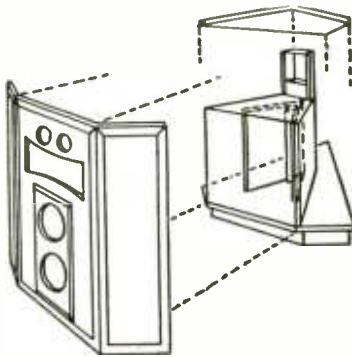

NEW KLIPZONS with Well Known SELF HOLDING points

The miniature
TEST PROD,
THAT'S A
CLIP
tool

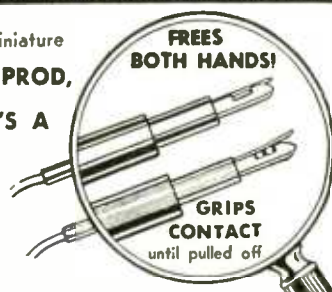

NOW! The new LONGIE ADAPTOR



converts old style prods to the new self-holding type

TYPE L Price 35c ea.

The Longie Adaptor is especially designed for test work in miniaturized or deep, close packed chassis. The extra long, slender points have the unique self-holding jaw and a needle-sharp point for piercing insulation. The Longie fits over R.T.M.A. standard test points directly, and over phonograph needle type with special insert supplied.



For A.F. and R. F. TESTING

TYPE S Price \$2.95

KLIPZON Type S Shielded Leads provide a reliable means of piping audio or radio frequencies in lab or service work. Total capacity only 25 mmf. for 3 ft. length. Complete shielding of leads eliminates stray pickups, feed-back, etc.



TYPE H Price \$2.50

KLIPZON Type H Jumbo Heavy Duty Test Prods and Leads bring the self-holding feature to conductors as large as #4 B & S Ga. Points are needle-sharp, and protected with insulating sleeves. Provided with 4 ft. stranded copper poly-ethylene rayon leads, equivalent to 18 B & S Ga.

- AT YOUR RADIO PARTS DISTRIBUTOR
- Write for FREE FOLDER #16

UNITED TECHNICAL LABORATORIES
Engineers • MORRISTOWN, N. J. • Manufacturers

**BE YOUR OWN BOSS!
MAKE MORE MONEY**



\$1.00 VALUE
25c
40,000 WORDS IN TEXT
NO ADS ALL "MEAT"!

In "CASH IN" you now get THE real money-makers — dozens of profitable tested mail order plans, confidential business secrets, dozens of practical tested formulas, successful tested schemes — actual experiences of men who have started on a shoestring—with less than \$10 capital. 25¢ a copy postpaid. Send U. S. stamps, money order, or coin.

Money Back Guarantee

NATIONAL PLANS COMPANY
1966R BROADWAY, NEW YORK 23, N. Y.

FIND THIS MAN!

NAME: Len Leonard. Age: 31. Height: 5' 10".
Hair: black. Eyes: brown.

ALIAS: "Moneybags Leonard."

WANTED: This man is urgently wanted by his wife, Leona and two children.

RECORD: For months he has been paying the highest, most ridiculous prices ever offered for new or used radio equipment. He buys anything in electronics from hams anywhere — and dishes out dough like it grew on trees.

IMPORTANT: You can get rich too! Sell your new and used radio gear to Len Leonard at—

COLUMBIA ELECTRONICS SALES
522 S. San Pedro St. Los Angeles 13, Calif.

3-SPEED CHANGER By WEBSTER-CHICAGO



Now
22.95

Plays 10, 7, and 12 inch records at speeds of 33 1/2, 78, or 45 R. P. M. This fine Webster has special arm with a feather-light touch to give extra long record life. The pick-up arm comes to rest position after records have played. Plays standard as well as micro-grooves. This chassis normally lists at \$47.50. Write for yours—while they last.

10% Cash With Orders

ALMO RADIO CO.
509 ARCH ST. & 6205 MARKET ST.
Philadelphia, Pa.
6th & ORANGE STS. • Wilmington, Del.
4401 VENTNOR AVE. • Atlantic City, N. J.
1133 HADDON AVE. • Camden, N. J.

AUTOMATIC M-90 AUTO RADIO



- Six Tube Superheteradyne • Three Gang Condenser • Powerful, Long-Distance Reception • Fits All Cars, Easy Installation
 - Mounting Brackets Included
 - 6 Tube model M90 *\$33.87
 - 5 Tube Model A-15 **\$28.76**
- *Above price includes Federal Excise Tax
Approx. shipping weight either radio (11) eleven pounds

MAIL US YOUR ORDERS

All orders filled within 24 hours.
Standard Brand tubes 50% off list

Bill Sutton's Wholesale Electronics
Fifth of Commerce Fort Worth, Texas

IF YOU BUY ON SPECIFICATIONS



and tops in value, you'll buy the

TWIN-TRAX* TAPE RECORDER

"Choice of Engineers Everywhere"

Compare the guaranteed specifications of a Twin-Trax Tape Recorder with any other recorder in any price class. You'll find that Twin-Trax gives you more features, better all-around performance and more value for your money. Complete specifications, performance ratings and direct factory prices in our catalog 5109. Send for it today.

*Trademark Reg.

AMPLIFIER CORP. of AMERICA
398 Broadway, New York 13, N. Y.

ELECTRONIC LITERATURE

Any or all of these catalogs, bulletins, or periodicals are available to you on request direct to the manufacturers, whose addresses are listed at the end of each item. Use your letterhead—do not use postcards. To facilitate identification, mention the issue and page of RADIO ELECTRONICS on which the item appears. All literature offers void after six months.

HEARING AIDS

In Circular 516 the National Bureau of Standards supplies information about hearing aid care and evaluation, and offers guidance in choosing one. The booklet also contains general information on the study of sound and the properties of hearing aids—particularly useful to persons wishing to explore this field. A hearing chart and a list of hearing-aid clinics is appended.

Copy obtainable for 15 cents from the Superintendent of Documents, U.S. Government Printing Office, Washington 25, D.C.

POCKET REFERENCE BOOK

The RCA Tube Department has issued the 1952 edition of its yearly reference book on RCA tubes, electronic components, test equipment, batteries, and miniature lamps. Data on more than 450 RCA receiving tubes and kinescopes and interchangeability information on non-receiving tube types is listed. A description of technical literature available on RCA items, basic data on television fundamentals, and helpful hints on TV troubleshooting by John Meagher, and other features are included.

Available from all RCA distributors for one dollar.

Radio Thirty-Five Years Ago
In Gernsback Publications

HUGO GERNSBACK Founder

Modern Electrics	1908
Wireless Association of America	1908
Electrical Experimenter	1913
Radio News	1919
Science & Invention	1920
Television	1927
Radio-Craft	1929
Short-Wave Craft	1930
Television News	1931

Some of the larger libraries still have copies of ELEC-TRICAL EXPERIMENTER on file for interested readers.

FEBRUARY, 1918 ELECTRICAL EXPERIMENTER

Hughes' Balance Locates Buried Shells
How New York Police Use Radio
New Radio Buzzer and Blinker Key
A Radio-Controlled "Tank," by Frank Coperman
Using The Rotary Condenser To Receive Undamped Waves
The How and Why of Radio Apparatus, by H. Winfield Secor
Construction of a Damped and Undamped Wave Receptor
High Frequency Phenomena and Experiments, by Frederick Von Lichtenow

FAST
TELEVISION
Tuner Alignment
to Crystal Accuracy



MODEL 680

R. F. MARKER and CRYSTAL CALIBRATOR

EXCLUSIVE — Contains Magic Eye circuit for calibrating and crystal accuracy.

FEATURES

- Provides accurate alignment of RF and overall sections of a TV receiver. 53-89 MC and 173-217 MC on fundamentals.
- Harmonic output on UHF and VHF.
- Will calibrate any other generator to crystal accuracy by means of a built-in magic eye zero-beat indicator.
- 2.5 MC crystal supplied — 2 other crystal holders provided.
- Permits adjustment of frequency of TV local oscillators to crystal accuracy.
- Moderately priced — the 680 will prove to be a valuable investment in modern TV equipment.

See the 680 at your jobber's today, or write for full details.

THE HICKOK ELECTRICAL INSTRUMENT CO.
10531 Dupont Ave. • Cleveland 8, Ohio

Become an Electrical Engineer

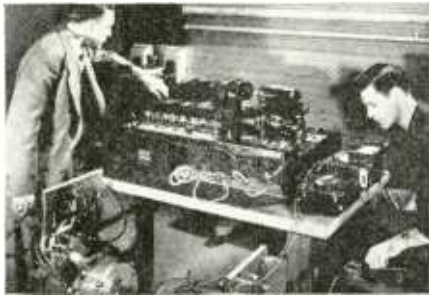

MAJOR IN ELECTRONICS



- B. S. Degree in 36 Months
- Radio-Television Technician Certificate in 18 Months

By 1954 there will be at least two positions for every engineering and technician graduate. This College offers a tested plan that permits you to enter these vast employment opportunities at an early date. First—you save a valuable year through optional year-round study. Second—you can receive advanced credit for prior training gained in the armed forces, other schools or field experience.

Enter Both Radio and Television Through This Plan

12 months or one-third of the B. S. degree course (Electronics major) — also brings you the Radio Technician's certificate. An added 6-month course qualifies you for the Radio-TV Technician's Certificate.

The Proven "UNIT CHASSIS SYSTEM"



of teaching was developed here. It "breaks down" the TV set by stages. You learn every component of all types and makes — and are prepared for future design changes, including the advent of color.

SPECIAL! Television Clinics

Ambitious Radio and TV Servicemen can enrol now in special one-month spring or summer clinics — to handle latest field service problems. Write for full details.

Over 48,000 former students from all states and 23 overseas countries. Faculty of trained specialists. Modern laboratories and equipment. Nonprofit technical institute and college in its 49th year.

MILWAUKEE SCHOOL OF ENGINEERING

Founded 1903—Milwaukee, Wis.

Terms open April, July, October, January

FREE — Write for "Occupational Guidance Bulletin," "Your Career" booklet, and Catalog.

Milwaukee School of Engineering
Dept. RE 252, 1025 N. Milwaukee
Milwaukee, Wisconsin

Without obligation send Catalog for
Electrical Engineering, B. S. Degree,
major in Electronics; Power; "Your
Career"; Occupational Guidance Bulletin
on: Radio-TV; Electrical Power;
 Welding; Heating, Refrigeration Air Conditioning.
 TV Service Clinic.

Name.....Age.....

Address.....

City.....Zone.....State.....

If veteran, indicate date of discharge.....

When a Picture Tube Bursts



Front view of set damaged by implosion.

Recently a survey was made to determine what safety precautions were being taken to insure against injury should a picture tube burst. The results showed that *not one service mechanic was practicing any safety measure!* All were aware of the dangers, yet all minimized that danger in their attitudes toward it. This survey covered only one city, but while the habit of ignoring safety may not be nationwide, it can be inferred that the percentage is high.

Watching technicians at work on these sets revealed that the tubes were removed frequently and often placed near the technician while he repaired the chassis. In many instances the work was done with the tube in place on the open chassis while that chassis was shifted to the convenience of the tools at hand.

The three photographs show graphically the results of an implosion of a 12-inch picture tube. They should leave little doubt in the mind of the reader that there are forces here great enough to cause serious injury to unprepared persons.

This does not imply that the set—properly housed in its case—is dangerous to the owner, if he keeps out of the cabinet and leaves repair and adjustments to qualified persons.

The particular set shown has a safety glass about $\frac{3}{16}$ inch thick which serves as a protective cover for the face of the tube. The glass caved in by the force of air pressure just as though it had been

struck with a heavy hammer. Shattered glass littered the inside of the cabinet and had moved inward with enough force to bend the metal picture frame and damage some exposed parts on the chassis.

The owner was watching a favorite program when the tube failed. He received no injuries, for the broken glass was confined to the interior of the cabinet. He did report that the bursting of the tube was accompanied by a loud pop which frightened him and the family by its intensity. (He also reported that the picture disappeared!)

In this instance the exact cause of the failure is not known. Possibly the tube face might have come into contact with the safety glass. It is also possible that there could have been a flaw in the glass envelope. Whatever the cause, the result is evident.

The bursting of a tube such as this is an *implosion*. In an explosion the forces act outward; in the implosion the forces are inward. There is a pressure of about 15 pounds on every square inch of the outside surface of the tube. The total pressure could be measured in tons for a large tube. The forces acting when a tube implodes toss rather heavy pieces of glass around at high velocity.

Even though surprisingly few service technicians observe safety precautions, just one bad accident would make it unnecessary for a man ever to observe any more. Imagine what would have happened had a man been holding that tube when it burst!

The least that can be done as a matter of protection is to wear goggles during periods of exposure. Tubes and chassis should be handled by qualified men who show due respect for the tube by wearing gloves and an apron.

One picture is that of a portion of the protective safety glass showing the fracture pattern. Notice that this fracture is similar to that of the pattern in an automobile window after a severe accident. Through experiences with auto safety glass it has been determined that the head is sometimes harder than the glass. But when it comes to safety, for our own sake we cannot be too hard-headed!

—end—

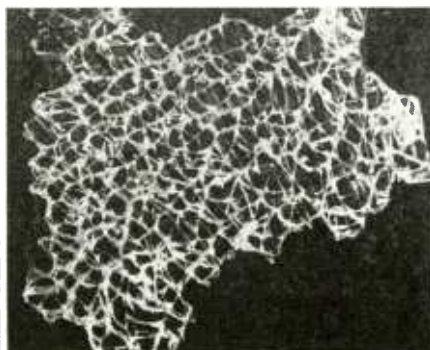

Shatter pattern of a typical fragment.

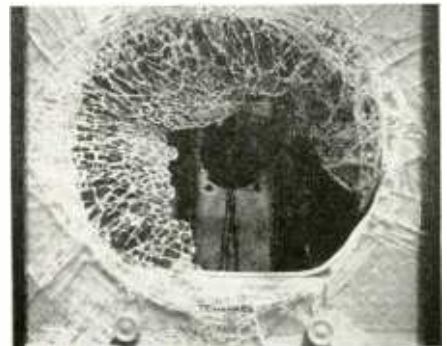

Close-up of the caved-in safety glass.

JUST FOR YOU . . .

Niagara HAS
WHEELER

SOUND POWERED
PHONES

- TALK UP TO 25 MILES WITHOUT BATTERIES OR ANY FORM OF POWER SUPPLY • EXPLOSION PROOF • NO FIRE OR SHOCK HAZARD • NO MAINTENANCE • TRUE SPEECH FIDELITY • MASTER INTERCOMM SYSTEM UP TO 12 STATIONS
- WRITE FOR FREE CATALOGS AND PRICES—IT'S TERRIFIC!



Hook-up to Antenna Lead-in



THE FUND TOPS \$9,000



It is heartening to watch the progress of the Help-Freddie-Walk Fund, which at this writing has reached a grand total of over \$9,100. As most of our readers know, Freddie, the three-year-old son of Herschel Thomason, radio technician of Magnolia, Arkansas, was born armless and legless. Through contributions to the fund, it has been possible to provide Freddie with artificial legs, and provision has been made to fit him with other mechanical appliances that are, and will be, so necessary.

Of course, the fact that Freddie is so young makes this a more difficult and expensive task. As the years go by, it will be necessary to change the mechanical appliances on which he is dependent to keep pace with the growth of an otherwise normal lad. So, we urge our readers not to let up in their donations to this worthwhile cause.

We are happy to note the following "group" contributions this month:

\$2.00 donated by H. Marcusa, Paterson, New Jersey, \$1.00 of which was contributed by his three children from their allowances: Paula, age 8, \$.50; Fred, age 5, \$.25; Stephen, age 4, \$.25.

\$7.00 donated by the Beginners Department of the Ridgewood Presbyterian Church, Ridgewood, New York. Called their "Thank Offering," this was contributed by forty children, between the ages of three and 5½.

\$24.00 donated by the employees of Radercraft Publications, Inc., publisher of RADIO-ELECTRONICS.

Make all checks and money orders payable to Herschel Thomason. Address:

Help-Freddie-Walk Fund
c/o RADIO-ELECTRONICS
25 West Broadway
New York 7, New York.

FAMILY CIRCLE CONTRIBUTIONS

Balance as of November 19, 1951	\$ 493.50
The Beginners Dept., Ridgewood Presbyterian Church, Ridgewood, New York	7.00
Mary Mihalyco, Skaneateles Falls, New York	5.00
Minnie L. Richards, Lodi, California	5.00
Mrs. E. Winicker, New Haven, Indiana	1.00

FAMILY CIRCLE Contributions received to December 19, 1951 \$ 511.50

RADIO-ELECTRONICS CONTRIBUTIONS

Balance as of November 19, 1951	\$8,482.60
L. F. Anderson, Titusville, Pennsylvania	5.00
Anonymous, San Diego, California	3.00
Anonymous, Hilo, Hawaii	1.00
Anonymous, Chicago, Illinois	2.00
Anonymous, Peabody, Massachusetts	1.00
Anonymous, New York, N. Y.	25.00
Anonymous, Alexandria, Virginia	8.00
Anonymous, Portsmouth, Virginia	10.00
Adolfo Mulet Blasco, Barcelona, Spain	1.00
W. J. Corbett, Springfield, Massachusetts	2.00
Hugh A. Curtis, Fredericksburg, Virginia	1.00
Pfc. Joseph F. Dupont, March AFB, California	1.00
Fred Henderberger, Victory, Wisconsin	2.00
J. Jensen, Gateborg, Sweden	1.00
H. Marcusa, and Children, Paterson, N. J.	2.00
Edwin Mutart, Pontiac, Michigan	5.00
O. E. Peterson, Chicago, Illinois	2.00
Employees, Radercraft Publications, Inc.	24.00
Donald F. Richardson, Tacoma, Washington	10.00
Victor L. Ruyven, Richmond Hill, New York	1.00
James Rynack, Jersey City, New Jersey	5.00

RADIO-ELECTRONICS Contributions \$8,594.60
FAMILY CIRCLE Contributions 511.50

TOTAL RECEIPTS to December 19, 1951 \$9,106.10

RADIO-ELECTRONICS for

SPEAKER SPECIALS

4" PM SPEAKER



High quality for AC, AC-DC portables, and intercomm. sets. New Alnico V magnet. Ideal for experimenter wanting quality at low price

Real Buy!

Each \$1.69
10 FOR \$15.90

5" PM



You can't go wrong on this number. A wise buy for the experimenter who doesn't want to pay too much for a good speaker. Alnico V magnet.

Bargain!

Each \$1.89
10 FOR \$17.50

QUALITY
P.M.
SPEAKERS



Exceptionally fine Hi-Fi speakers for high quality use at a low price. All with 3.2 voice coil, less output.

Size	Stock No.	Watts	Each
2"	2AMS	1-2	2.19
3"	3AMS	2-3	2.19
4"	4AMS	2-3	2.34
5"	5AMS	2-4	2.49
6"	6AMS	3-5	2.85
8"	8EVS	4-6	4.35
10"	10EVS	4-6	5.64
12"	12EVS	4-6	6.24



8" P.M.
SPEAKER

A fine quality, P. M. speaker for Hi-Fi service. Heavy 8 ounce magnet. Ripple cone. Excellent frequency response. A typical Niagara Bargain!

A Niagara Bargain!

\$3.89 Each
10 FOR \$37.50



14 KV. H. V.
FLYBACK XFMR

Corona Sealed
Universal
Replacement

Type horizontal output and high voltage transformer for TV sets up to 20 inches. Completely encased in chip-proof plastic to prevent "corona" effect or arcing. An exceptionally high rated transformer at a new low price. Individually boxed with instructions, specifications and mounting hardware. Meas. 3x2x2 1/2" h. Shipping wgt. 3 lbs.

Each \$5.97

HEART OF
THE BC-221
FREQ. METER



This VFO Sub-Assembly, used in BC-221 Freq. Meter, FULLY WIRED and mounted on sturdy aluminum sub-chassis, ready for installation. Brand new—in original packing. Very special.

Each \$4.95

FAMOUS MAKE
SELENIUM
RECTIFIERS



Ideal for use in TV & Radio Replacement. All first quality, guaranteed brand new, fresh factory stock. Buy now while still available. All 130 V.

SINGLY		LOT OF		SINGLY		LOT OF	
D.C. MA	EACH	10 EACH	D.C. MA	EACH	10 EACH	D.C. MA	EACH
65	.86	.83	275	1.69	1.55	75	.78
75	.96	.92	300	1.89	1.75	100	.96
150	1.17	1.10	400	2.15	2.01	200	1.35
200	1.35	1.27	450	2.54	2.43	250	1.50
				2.64	2.52		

WEBSTER-CHICAGO
NEW MODEL 100-75



AUTOMATIC
RECORD
CHANGER
WITH
"FLIP-OVER"
CARTRIDGE

One of their latest models. Plays 12, 10 or 7 inch records at 33 1/3, 45, or 78 R. P. M. New spindle carefully lowers unplayed record stack. Balanced arm assures light needle pressure and long wear. Needle-tip included for standard or micro-groove records. Inside-out records played without any adjustment. Pickup arm comes to rest position after last record has played. Complete factory packed and sealed record changers, normally listing at \$47.50—While they last. \$2485

Shipping Wgt.

ONE OF AMERICA'S GREAT RADIO STORES

Niagara

RADIO
SUPPLY
CORP. Dept. 2-E2

160 Greenwich Street, New York 6, N. Y.

Digby 9-1132-3-4

Tel-a-Ray's

BIG

FOUR

of TV reception

For television that's
bright and clear
Wherever you are . . .
far or near



Good reception up to 200 miles or more!

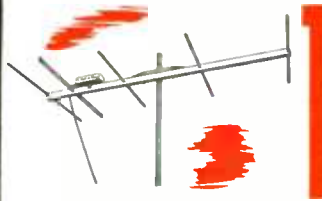

Models T and TD Antennas . . . famous for providing clear, stable, interference-free reception at almost unbelievable distances. With the Pre-Amplifier, they give up to an amazing 300 times gain over dipole. Rugged, weatherproof construction.

Signal amplification without noise!

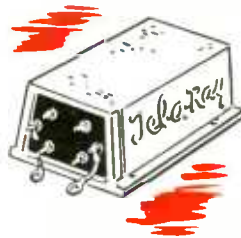

The unique, research-perfected Pre-Amplifier . . . the only device of its kind . . . an antenna- or mast-mounted installation that dramatically multiplies the signal gain while keeping noise at a minimum. Eliminates snow and makes signals strong and stable. Sold as a weather-sealed unit and guaranteed against weather damage.

Middle-distance champions!



Models R and RD Antennas . . . designed to give the finest TV reception to the outer service areas at low cost . . . America's champion middle-distance performers. Same quality construction features as Models T and TD.

Amazing New Switching Booster Permits Switching Between Four Antennas

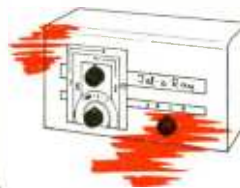

The new Tel-a-Ray Booster is designed for areas where two or more channels may be received with separate antennas. It is a low noise level, high gain booster that both controls and supplies power for the Tel-a-Ray Antenna system. You switch from one antenna to another with just one knob.

HOW TO INCREASE VOLUME AND PROFITS NOW

A huge market is opened up for you by Tel-a-Ray long-distance antennas and the Pre-Amplifier. With them, you can sell television in areas where it could not otherwise be sold successfully. For the big, established primary area market, the Butterfly has the features needed for capturing replacement sales . . . for building profits and volume against the strongest competition. These are products of the finest construction and appearance . . . ruggedly made of corrosionproof materials and unconditionally guaranteed against wind and weather damage. Let us send you full details.

Tel-a-Ray. America's most progressive antenna manufacturer, has applied to the FCC to operate a UHF television station on Channel 50 . . . Tel-a-Ray's research engineer is keeping pace with America's fastest-growing industry, has developed on effective UHF antenna. Such progress assures you finer television.

Send the coupon
for full information and
free sales literature



Tel-a-Ray ENTERPRISES, INC. P. O. Box 332E, Henderson, Kentucky

Yes . . . send me full information and descriptive literature on
 Models T and TD Antennas; Models R and RD Antennas;
 Tel-a-Ray Switching Booster; The Pre-Amplifier.

NAME.....
 COMPANY.....
 ADDRESS.....

TV CHASSIS AND CABINETS

POWER PACKED FOR PEAK PERFORMANCE

Factory wired aligned tested before SHIPMENT

\$149.95

with HI GAIN CASCODE STANDARD COIL TUNER & RCA HI-FI 12" SPEAKER COMPLETE WITH FED. TAX LESS CATHODE TUBE

4 MICROVOLT SENSITIVITY WITH FULL 4 Mc BAND WIDTH

Will perform 200 miles or better

from 16" to 24". Super engineered for sharper clearer pictures than ever before. Improved keyed AGC, 15 KV output; 3 stage SYNC separator and clipper; molded plastic condensers. New improved high voltage system. 5 hour minimum heat run at factory; high gain front and down to 4 microvolts; SYNCHRO LOCK; freedom from arcing and corona leakage. Armstrong FM sound system. Improved linearity. Phono connection and switch on chassis.

NEW K3C 630 DX CHASSIS

WITH **CASCODE TUNER**
Licensed under RCA PAT. RMA Guarantee

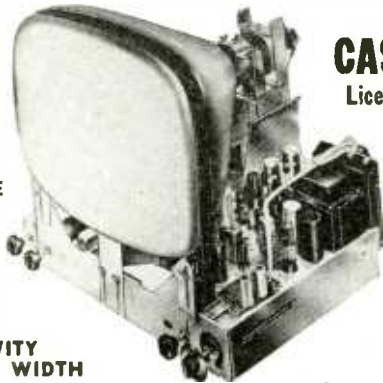

CHASSIS MOUNTING BRACKETS \$6.50

—Directly adaptable to color & U.H.F. This SUPER DX "630" 30 tube is

POWER PACKED FOR PEAK PERFORMANCE in all FRINGE AREAS—Handles all tubes

ENCHANTING BEAUTY

These magnificent hand rubbed cabinets made to suit every taste and any pocket book.



FOR YOUR HOME

Designed specifically to house the new DX "630" chassis 12 inch speaker and up to 20" tube.

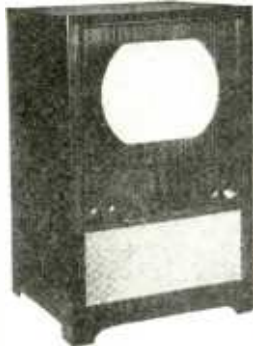

ECONOMY

38x22x22 16-17" TUBE \$49.95
41x25x23 16-20" TUBE Mahogany \$59.95
For 24" tube \$74.95
Blonde \$10.00 additional

ELITE
Combination 39x40x23 1/2 Red Antique Gen. leather Gold leaf hand tool \$149.95
In limed Oak gold colored leather \$159.95
MOUNTING BRACKETS ARE INCLUDED IN PRICE OF CABINETS



STRATFORD

40x28 1/2 x 23 1/2 Gen. Crotch Mahogany doors \$89.95

100 Assorted Resistors 1/2 to 2 watts \$2.29

REGENCY BOOSTER \$19.11 Model DB 410

Nationally known 3 speed record changer \$24.75

Send postcard to be on our free mailing list.

SPECIAL VALUES!
300 OHM WIRE
1000 Ft. \$17.95

TV TUBE EXTRA Standard Brands—1st Quality

12 1/2" round	\$22.50
14" Rectangular	23.95
14" Rectangular	25.95
16" Rectangular	29.95
17" Rectangular	32.95
20" Rectangular	42.95
24" Round metal	74.95
Ring & sleeve for 24"	7.50

All tubes carry full 1 year Manufacturer's guarantee

WE CARRY A COMPLETE LINE OF "630" Component PARTS. We have a full line of Radio parts. From 40% to 60% off list. Write for prices.

AIREX BRAND COMPANION MODEL WOW WHAT A BUY. READY TO PLAY.

JUST PLUG IN.

CASCODE STANDARD COIL 4 IF STAGES

RMA guarantee on all parts. 6 month guarantee on picture tube. DX model for all fringe areas. 22 Tubes. Electrical engineers bring you an outstanding receiver at hard to believe low prices.



17" \$154.95
20" \$179.95

24" TV Console \$299.95
One year warranty on parts & tubes. Prices include all Federal taxes.

17" \$174.95
20" \$199.95



All merchandise in brand new, factory fresh & fully guaranteed. Mail and phone orders filled upon receipt of certified check or money order of \$25 as deposit on TV chassis. 20% on other items. Balance C O D. FOB New York. Prices subject to change without notice. Prices lower than OPS Regs.

AIREX RADIO CORP.

171 WASHINGTON ST., N. Y. C. 7, N. Y.
PHONE WOrth 2-4029

STROMBERG-CARLSON TC19

Normal tuning procedure on these sets is to tune for the best picture. Sound usually comes in at its best at this point. However, in some remote fringe areas, best picture and maximum sound come in at different points on the tuning dial.

To improve this condition so sound and picture come in best at the same point, the coupling capacitor (C70) to the 21.9-mc trap in the plate circuit of the third i.f. amplifier has been decreased from 2.2 µf to 1 µf. This increases the ratio of sound to picture sensitivity of the receiver. When making this modification of receivers in the field, realign the 21.9-mc trap and check the alignment of the i.f. circuits.—*Stromberg-Carlson Current Flashes*

PHILCO 48-1001

The set came into the shop with a very dim picture, no vertical sync, and a loud popping sound from the high-voltage cage. A check showed a steady 8,000 volts at the filament of the high-voltage rectifier. There were a few faint sparks around the base of the 1B3-GT. We cleared these up by removing the unused pins from the rectifier socket. The original troubles remained. Finally we checked the high-voltage filter resistor and found it open. We soldered a 1-megohm, 1-watt resistor, across the old one and the set's performance returned to normal. We shunted the old resistor instead of removing it, because the filament leads are very brittle and break easily.

Another odd trouble in the same model was loss of vertical deflection caused by a shorted vertical-deflection coil. When the C-R tube was removed, the coil showed the normal 30-ohm resistance. Replacing the tube caused the short to return. We found that the tube pushed the 1,000-ohm shunt resistors against the deflection coil which is grounded. A few strips of fiber were interposed between the resistors and the deflection coil windings and held in place by a few dabs of cement. After the coil was remounted on the picture tube the deflection was normal.—*Hyman Herman*

ADMIRAL 20A1, 20T1, 21A1

If the 1/4-ampere high-voltage fuse blows after the set has warmed up, look for a thermal short between heater and cathode of the 6W4-GT damper tube. In these and several other models, the cathode is nearly 400 volts positive while one side of the heater is grounded.—*Leonard Pfeiffer*

ADMIRAL 6T06 (CHASSIS 4A1)

The set was dead and the B-battery weak. Replacing the battery did not restore the set to normal operation. The bias resistor was charred and open. A careful check showed a break in the insulation on the B-plus battery lead at the point where it entered the chassis. The resulting short circuit burned out the bias resistor. After replacing the resistor, we installed a rubber grommet in the hole where the battery leads pass through the chassis. This will prevent future troubles of this nature.—*Cecil Harrison*

TV

Lead-in Wire

Only \$14.50 per 1000 ft.

NOW . . . BUY DIRECT FROM THE MANUFACTURER

All Brand New 300 ohm Wire At A Tremendous Saving! Tested and Proven For Better Reception . . . Our Most Popular Item . . . You Never Need Pay Any More . . . Vinyl Plastic Insulation.

ORDER NOW . . .

We Ship Prepaid Anywhere in the United States. Order in Reel Lots Only . . . One Reel The Minimum Each Reel 1500 Feet. (\$21.75)

NATHAN

MANUF. & DISTRIB. CO., INC.
2171 East 25th St. • Los Angeles 58, Calif.

Please be sure to mention

RADIO-ELECTRONICS

when writing to advertisers

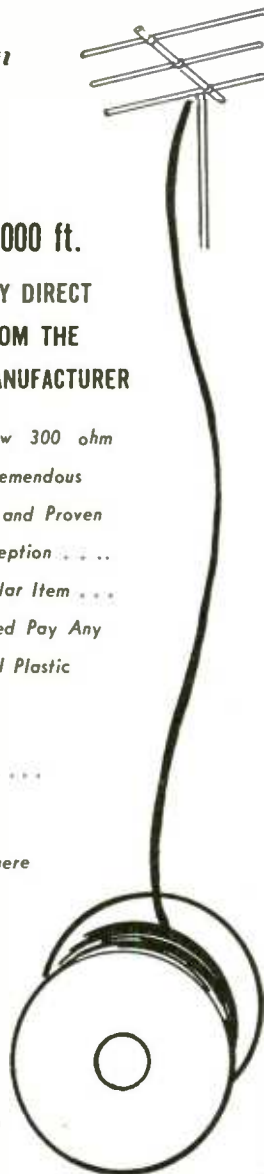

CROSLY RECORD CHANGERS

Turntable mats sometimes curl or become loose on the R-201, 10-101 45-r.p.m. record changers. To repair, remove the original mat by using either kerosene, gasoline, or methyl ethyl ketone as a solvent for the original cement. The changer manufacturers use different types of cements, so it may be necessary to try more than one of the solvents named above to find one which will loosen the cement sufficiently to permit the mat to be removed.

Clean the turntable thoroughly, being careful that the finish on the changer is not marred by the solvent.

Install a new mat, part No. 146507-8, by applying methyl ethyl ketone to the underside until the entire surface is tacky. Place the mat on the turntable and weight it down over the entire area until the cement is thoroughly dry.

The above chemicals may be obtained from any supplier dealing in solvents. —Crosley Service Bulletin

DU MONT TV SETS

Sometimes the picture gets snowy after the set has been operating several hours. Check all tubes and components in the video i.f. strip and video amplifier. If all components check good, open up the Inputuner and check the 10,000-ohm resistor in the plate circuit of the 6J6 r.f. amplifier. This resistor sometimes increases to several times its original value, thus reducing the gain of the amplifier.

This trouble originating in the front end can sometimes be detected by the fact that the low channels are snowy and the high channels come through with fairly good signal strength. This effect is probably caused by the higher frequencies being bypassed around the r.f. circuit by the stray wiring capacitance and interelectrode capacitance of the 6J6.—James T. Smith

BUZZ IN TV SETS

An annoying noise which sounds like intercarrier buzz sometimes occurs on split-sound and intercarrier models. In several instances, this trouble has been traced to ineffective grounding of the outer coating on the picture tube caused by bent or missing grounding springs.

This trouble can be cleared up by providing a good connection between ground and the outer coating of the tube.—Arthur D. Marikle

PHILCO 1256 COMBINATION

The set required frequent retuning as it warmed up. The oscillator tube, voltages, and components were O.K. Since the trouble was obviously in the oscillator circuit, we took a chance and ripped the mica trimmer off the oscillator section of the main tuning gang. This trimmer was replaced with a new ceramic trimmer solidly mounted on the frame. After retuning the oscillator, the set worked fine.

Apparently a thin film of wax had formed on the mica of the original trimmer. Heat melted the wax and caused a change in oscillator tuning capacitance. This service hint may well be applied to any set which has the same symptoms.—David Gnessin

—end—

Sensational TV BARGAINS!

Rocket YAGI

5 ELEMENT TV ANTENNA Excellent Pictures in Fringe Areas

HIGH GAIN. Clearer, sharper, steadier pictures. PERFECT PICTURES IN FRINGE AREAS. Minimum interference from ghosts and noise due to a directive pattern. Five elements include one folded dipole, three directors, and one reflector. Supplied less mast. MATCHES 300 OHMS IMPEDANCE. Molded insulator provides additional strength. Exclusive design mast clamp prevents antenna turning or coming under any conditions. STURDY. TROUBLE-FREE CONSTRUCTION. No return calls. No broken elements. Stands the test of severest weather. Elements of extra heavy aluminum-clamped top and bottom. QUICK RIG. Completely pre-assembled. Just swing elements into line and tighten wing nuts. Simple . . . quick . . . easy. Available for any channel, high or low band.

Channels 2 and 3 \$7.95 each 4, 5, and 6 \$6.95 each
Channels 7 to 13 \$3.95 each

EACH CHANNEL requires a DIFFERENT Yagi. When Ordering specify exact channel number desired. SOLD ONLY BY MAIL BY NATIONAL ELECTRONICS

Rocket DIRECTRONIC MOTORLESS TV ANTENNA

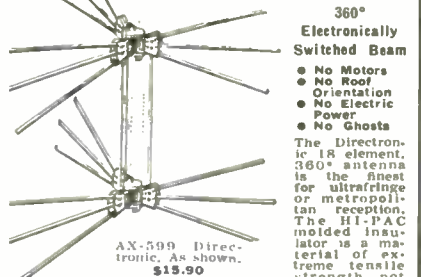

AX-599 Directronic, As shown. \$15.90

The Directronic 18 element, 360° antenna is the finest for ultrafringe or metropolitan reception. The HI-PAC molded insulator is a material of extreme tensile strength not affected by weather or temperature, either mechanically or electrically. Included in the AX-599 "Servicemen's Array" are:

- 18 hi-tensile aluminum alloy elements
- 1 set of connecting stubs (3)
- Universal U Clamps for masts to 1 1/2"
- Directronic Beam selector
- 75 feet of Tri-X Cable
- 1 stacked array per carton

AX-56 Directronic, 6 element Single \$ 9.95
AX-56B Directronic, 12 element Stacked 14.25
AX-59 Directronic, 9 element Single 9.95

All above antenna prices include Tri-X Cable and Switch.

SOLD ONLY BY MAIL BY NATIONAL ELECTRONICS

Rocket ALL CHANNEL CONICALS



This sturdy, all-aluminum constructed TV antenna is designed for broad-band reception on all TV channels, plus FM. High Gain, 4 to 1 front to back ratio. All channels 2-13. Uni Directional. Maximum signal to noise ratio. For use with 72-150-300 ohm lines. Low inception angle. Complete with all hardware—less mast.

Single Bay \$3.75 each
Stacked Array with Tie Rods \$8.20 each

SOLD ONLY BY MAIL BY NATIONAL ELECTRONICS

- 1 1/4" O.D. Mast Steel (Dualcoated) 5' crimped \$1.05
- Mast Steel (Dualcoated) 10' \$1.95
- Mast Steel (Zinc plated) 10' \$1.99
- Mast Connectors for 1 1/4" O.D. Mast—10" long 49c
- 3 Conductor Motor Wire 3c ft.
- 4 Conductor Motor Wire 4c ft.
- Peak Roof Saddles (Will take up to 1 1/2" O.D.) \$1.49
- Twin Lead 300 Ohm—270 Mil—Solid 21c ft.
- Twin Lead 300 Ohm—25/50 Mil—7/28 Stranded 3c ft.
- Double Stacking Assembly for stacking \$1.70 set
- Aluminum Guy Line 7/18—Stranded 300 ft. coil \$4.95
- Arrestors (TV-Lighting) 69c
- Chimney Mount—Complete with Straps \$1.19
- Cable—72 Ohm 6 1/2c ft.
- Guy Wire—Galvanized—4 strand #20 1/2c ft.
- Guy Wire—Galvanized—8 strand #20 3/4c ft.
- Guy Wire—Galvanized—11 strand #20 1 1/2c ft.
- Boosters—Anchor—101-75 \$22.50
- Fee—8-505 \$26.97
- Stand-off Screw Insulators—3" for 300 Ohm \$2.75 c
- Stand-off Screw Insulators 7" for 300 Ohm \$5.50 c
- Strap Clamp Stand-off Insulators—3" \$6.50 c

PRICES SUBJECT TO CHANGE WITHOUT NOTICE ALL PRICES F.O.B. CLEVELAND, OHIO

Do not remit more than complete purchase price. Pay shipping charges on receipt of goods. 25% Deposit on C.O.D. orders, please. Money Back guarantee

For Faster Service, Address Desk RE-2

National Electronics
OF CLEVELAND
THE HOUSE OF TV VALUES
Delco Building • Cleveland 3, Ohio

BE "ECONOMY-WISE" WITH

GREYLOCK

TERRIFIC TUBE BUYS!

All tubes listed below carry 6 month Guarantee—exception only burnouts and breakages. At these sensationally low prices, these tubes must be ordered in quantities of AT LEAST 10 ASSORTED TYPES add 10% for orders under 10 tubes. All individually boxed in attractive Greylock Cartons.

1L4	6AT6	6J5GT	12AU6
1S5	6AU6	6J7GT	12A8GT
1U4	6AV6	6S4	12BA6
1U5	6BA3	6SK7GT	12F5GT
3Q4	6BE6	6V6GT	12BE6
3V4	6C4	6W4GT	25Z5
5Y3GT	6C5GT	6X4	35W4
6AL5	6C6	6X5GT	35Z5GT
6AQ5	6CB6	12AT6	117Z3

YOUR NET COST EACH 49¢

0Z4M	6AR5	12AU7	35B5
1R5	6R7GT	12AV6	35C5
1T4	6SQ7GT	12AX7	50C5
3S4	6SN7GT	12SK7GT	50L6GT
5X4G	6U4GT	25L6GT	

YOUR NET COST EACH 59¢

1V2	6BC5	12AX4GT	12SQ7GT
5U4G	6SA7GT	12BA7	25Z6GT
6AB4	6SL7GT	12J5GT	35Y4
6AQ6	12AL5	12Q7GT	50B5
6AS5	12AV7	12S8GT	80

YOUR NET COST EACH 69¢

1L05	6BA7	7A7	12K8GT
6AG5	6BQ6	7E5	12SA7GT
6AK5	6T8	7N7	12SN7GT
6AK6	6Y6G	7X7	25BQ6GT
			35L6GT

YOUR NET COST EACH 79¢

12BH7	6AC7	14C5	7C7
19T8	32L7GT	1A7GT	

YOUR NET COST EACH 99¢

1LA4	1N5GT	6BH6	6J6
1LN5	1X2	6BJ6	6SG7
			7A8
			12AT7

YOUR NET COST EACH 89¢

6BG6G	\$1.09	12AZ7	\$1.29
19BG6G	1.09	6AH6	1.29
1B3GT	1.19	6BQ7	1.49
6AG7M	1.19	6V3	1.59
6CD6G	1.29	807	1.79
6BL7GT	1.29	7JP4 CRT	16.50

SPECIAL! 6AR6 \$2.49



SPEAKER SPECIALS
Permanent Magnet—Alnico No. 5 Slugs
3" PM88 oz. \$1.09
4" of 5" PM88 oz. 1.29
6" PM 1.0 oz. 1.59
8" PM 1.3 oz. 2.19
8"x8" PM 3.16 oz. 3.49
8" PM 2.15 oz. 3.69
10" PM 3.8 oz. 5.95
12" PM 3.2 oz. 4.95

GREYLOCK "BONDED" ELECTROLYTIC CONDENSERS

Guaranteed Fresh Stock 

AUTO SPEAKERS
7/8" 4-ohm dynamic less output \$2.19
7/8" PM less output 4.95

LOTS OF 10 YOUR ASSORTMENT

Mfd.	W.V. DC	Net each	Mfd.	W.V. DC	Net each
16	150	.29	40 x 40	150	.45
24	150	.35	50 x 30	150	.45
30	150	.35	8	450	.29
40	150	.39	8 x 8	450	.49
20 x 20	150	.39	16	450	.39
20 x 40	150	.39	30	450	.44
30 x 30	150	.44	40	450	.49



4 ELEMENT CONICAL ANTENNAS

Constructed of reinforced butt seam aluminum elements and strong steel cross bars; ruggedized insulators.
SINGLE Order #P-003 \$3.99
STACKED Order #P-004 \$8.29
Extra elements for conicals make fan-flector type.
P-009 Low Band Elements, each 49¢
P-010 High Band Elements, each 35¢

Above prices are for minimum quantities of 10 asstd. condensers. Deduct additional 10% discount in lots of 100 assorted condensers.

WHILE THEY LAST! FAMOUS MAKE TV BOOSTER
List \$2.50—Order #Q-001 16.95 FOR ADDITIONAL VALUES:

Radio Hams, Radio & TV Servicemen, Electronics Experimenters—write for Greylock's Great New Catalog C-2, crammed full of money-saving values for you!

CHIMNEY MOUNTS #E-1585 Only 99¢

TERMS: Net C.O.D., F.O.B. New York City. 25% Deposit on all C.O.D. orders.

GREYLOCK ELECTRONICS SUPPLY CO.
115 Liberty Street - New York 6, N. Y.



C. H. Griffith

Charles H. Griffith was appointed general sales manager of the INTERNATIONAL RESISTANCE CO., Philadelphia. He will continue his duties as manager of the Radio Sales Division. In his new capacity, he will coordinate the activities of all sales divisions throughout the IRC Organization.



W. Carlin

William Carlin was appointed manufacturing manager of the Cathode-Ray Tube Division of ALLEN

B. DU MONT LABORATORIES. He was formerly assistant manufacturing manager of the Division. In his new position, Mr. Carlin will head the manufacturing activities of the division.

Harold S. Stamm, former administrative assistant to the advertising manager of the RCA TUBE DEPARTMENT was promoted to the position of manager of advertising and sales promotion of the department. He succeeds Lawrence LeKashman, who resigned.



H. S. Stamm

Robert L. Wolff was promoted to the position of director of products engineering for the CENTRALAB DIVISION OF GLOBE-UNION, Milwaukee. He was formerly chief radio-electrical engineer.



R. L. Wolff

Lawrence LeKashman joined ELECTRO-VOICE, Buchanan, Mich. as vice president. He was former advertising and sales promotion manager of the Tube Department of RCA. Mr. LeKashman is an enthusiastic "ham" and the author of many technical articles, some of which have appeared in RADIO-ELECTRONICS.



L. LeKashman

Paul Hines joined WORKSHOP ASSOCIATES, division of the Gabriel Company, as director of engineering. He will head the new Workshop Laboratory now being built in Natick, Mass. He was formerly with Raytheon Manufacturing Co.



P. Hines

PARTS LISTS

Bills of material for most of the pieces of equipment described in RADIO-ELECTRONICS construction articles are on hand at all radio parts dealers and distributors who sell the magazine. See your dealer for a complete parts list of any of this apparatus you wish to construct.

STAN-BURN E.D.A.R.K.E.

★ ANTENNAE SPECIALS ★

★ DOUBLE V 3/4" Dowel	1-11	12 or more
★ DOUBLE U 3/4" Dowel	\$2.98	\$2.20
★ DOUBLE V 1/2" Dowel	3.45	2.45
★ 10 Element Conical 3/4" Dowel	3.95	2.95
★ Folded Hi Straight Low Quick Rig 1/2" elements	3.55	2.55
★ WINDOW CONICALS	4.25	3.25
	4.95	3.75
MASTS		
★ 5 FOOT SWEDGED	.89	.69
★ 10 FOOT PLAIN	1.59	1.29
TV WIRE		
★ 42 Mil. 300 OHM	\$15.95 M Ft.	
★ 55 Mil. 300 OHM	17.95 M Ft.	
★ 72 OHM COAXIAL	52.50 M Ft.	

★ CATHODE RAY TUBE SPECIALS ★

★ 71P4	\$15.00	16RP4/KP4 N.U.	23.00
★ 10BP4	14.95	16BP4A	25.00
★ 10BP4 N.U.	19.95	17BP4A	27.00
★ 10BP4A N.U.	19.95	20CP4	39.95
★ 12LP4	19.95	20CP4 Sheldon	37.00
★ 12LP4A	19.95	19AP4A	47.95
★ 14BP4	19.95	19DP4A	47.95
★ 16DP4A	26.00	24AP4A	73.00
★ 16CP4	33.00	Single ion traps	.39
★ 8AP4A	39.00	Double ion traps	.59

★ CHASSIS 630 K38 VIDEO	\$139.50
★ OPEN FACE CABINET	39.00

★ TRANSFORMERS DEFLECTION YOKES ★

★ RCA type for 16" to 24" X032	\$3.85	Cosine Ferrite Todd	
★ G.E. Type for 16" to 24" X045	\$3.85	Yoke 70°	\$4.20
★ These are very special prices while they last!		Regular 70°	
		Yoke	3.85

★ Condenser Specials BY PASS— ALL GUARANTEED ★

★ 20x20-150 Stan Burn	.41	4" P.M.	\$1.64
★ 50x30-150 Stan Burn	.49	5" P.M.	1.75
★ 20x150 Stan Burn	.32	6" P.M.	2.41
★ 8-450 Stan Burn	.41	8" P.M.	3.41
★ 16-450 Stan Burn	.49	12" P.M.	6.33

★ Speaker Specials ALL GUARANTEED ★

★ 4 Prong Vibrators each	\$1.29	4 x 6 P.M.	2.19
★ Lots of 12 or more	1.19	5 x 7	3.43
★ Standard TV Tuners	\$18.95	10" P.M.	5.48

★ RCA Guaranteed Tuners (with tubes) Special, while they last \$12.00

★ AUTHORIZED DISTRIBUTORS for: General Electric, Kenrad, Tung-Sol, National Union, Jewel, De Wald, Regal, Automatic and Setchel Carlson.

★ We carry a complete line of popular makes of radio and TV tubes, at 50% discount. Also many other special purpose and transmitting tubes, and all electronic parts and equipment at lowest prices. Send us a list of your requests for quantities and prices.

★ Terms: 20% with order. Balance COI All prices FOB. New York Warehouse. Minimum order \$5.00

★ Write for our latest price list to Dept. RE-2

STAN-BURN RADIO and ELECTRONICS CO.
(C.B.S. THEATRE BLDG.)
1697 BROADWAY • NEW YORK 19, N.Y.

Every RADIOMAN can use these SERVICE HINTS!
Valuable Manual Yours—FREE
Write today—no obligation
FEILER ENGINEERING CO. Dept. 2RCZ-1
8026 N. Monticello Ave., Skokie, Ill. (Suburb of Chicago)

REDI-VOLT MODEL 60 PLUG-IN D.C. POWER SUPPLY
Furnishes 60 ma. filtered D.C. at 140 V. with 115 V A.C. input.
A thousand uses, makes building neat equipment easier. Use like a tube, plug into socket on radio, amplifier, or other chassis.
Price \$2.95 Satisfaction guaranteed.
Post paid U.S.A.
Z-LAB CO. Box 48, Grand Rapids, Mich.

Personnel Notes •

... Dr. Irving Wolff was named director of research for the RCA LABORATORIES DIVISION of the Radio Corporation of America with headquarters in the David Sarnoff Research Center, Princeton, N. J. Dr. Wolff had been director of radio tube research for RCA Laboratories.

... Fred H. Garcelon and George Deters were appointed Eastern and Mid-western sales managers respectively for HYTRON RADIO & ELECTRONICS CO., Salem, Mass., a division of CBS.

... E. W. Merriam joined the Radio and Television Division of SYLVANIA ELECTRIC PRODUCTS as service manager. He was previously service manager of the RTMA. Sylvania also announced the promotion of Ralph R. Shields, former engineer for Test Equipment Merchandising, to the position of merchandising supervisor for the television picture tube division in Seneca Falls, N. Y.

... Jack C. Keith, sales manager of HOWARD W. SAMS & Co., Indianapolis, was elected vice president in charge of sales.

... Albert W. McCarty joined CLAROSTAT MFG. Co., INC., DOVER, N. H. as personnel manager. He held the same position with General Foods Corp.

... George I. Long was elected vice president and general manager of AMPEX ELECTRIC CORP. Redwood City, California. He joined Ampex as treasurer.

... Frank C. Beldowski joined THOMAS ELECTRONICS INC., Passaic, N. J., as plant manager. He was formerly with Du Mont.

... Charles Penk, formerly vice president of ALLIED ELECTRIC PRODUCTS, INC., parent company of Sheldon Electric Company, Irvington, N. J. was elected president. Nathan Chirelstein, former president of Allied, was elected to the newly created post of chairman of the board.

... Nat Malamuth, sales manager of the TEL-O-TUBE SALES CORP., New York City, was appointed manager of the government contract Section, electronic equipment division of the Tel-O-Tube Corp. of America, East Paterson, N. J. ... W. L. Rothenberger, former manager of sales operations for the RCA TUBE DEPARTMENT, was appointed manager of the Eastern Region of the RCA Victor Division. At the same time, the company announced the establishment of a new Northeastern Region to be managed by R. M. Macrae, formerly assistant regional manager of N.Y.

... Arthur Richenthal, attorney, was elected to the position of secretary of the STANDARD COIL PRODUCTS Co., INC. ... Dorman D. Israel, executive vice president of EMERSON RADIO PHONOGRAPH CORP., was appointed a member of the Radio & Television Manufacturers Industry Advisory Committee of the NPA for the term ending June 1st, 1952.

... Robert T. Leitner joined the engineering staff of TECHNICAL APPLIANCE CORP., Sherburne, N.Y. He was previously with the Antenna Laboratory of Ohio State University.

—end—

FREE! BIG NEW 1952 CONCORD CATALOG

Send for it NOW!

YOUR COMPLETE BUYING GUIDE for every need in— TV • RADIO • ELECTRONICS

You save time and money—with this bigger, better 1952 Buying Guide! Here is page-after-page full of the latest and greatest values in Television, Radio and Electronics. It brings right to your finger tips one of the world's largest stocks of nationally-known guaranteed quality parts and equipment—High Fidelity, TV, and Radios, Phonos, and Recorders, Sound Systems, Ham Gear, Test Equipment, Electronic Tubes, Parts, Books, Kits, and Tools. You find it quick and easy to get whatever you need—at the very lowest prices. Send for your FREE Concord Catalog today! Have it handy for quick reference.

FREE! New 2nd Edition HIGH FIDELITY GUIDEBOOK



Send for your FREE copy today.

TELLS ALL you want to know about High Fidelity. How to bring concert hall realism into your home. What makes a real Hi-Fi Music System. How to select custom components or complete ensembles at modest cost. Shows various installations and a complete range of famous guaranteed Hi-Fi units.

CONCORD RADIO CORPORATION
901 W. JACKSON BLVD. • CHICAGO 7

CONCORD RADIO CORP., Dept. JB-52
901 W. Jackson Blvd., Chicago 7, Ill.

Rush FREE Big, New CONCORD Catalog
 Rush FREE High Fidelity Guidebook

Address _____

Name _____

City _____ Zone _____ State _____

IT'S NEW

THE 10-POUND PORTABLE BATTERY-OPERATED MIDGET TAPE RECORDER



The MAGNEMITE*

Designed by A. C. Shaney, internationally-known leader in tape recorder development, and built by Amplifier Corp. of America, leaders and pioneers in magnetic recorders since 1936 — the Magnemite* is also a leader in its field — the first completely portable tape recorder, powered by self-contained dry batteries! Measuring only 11½ x 8½ x 5½ inches, and weighing only 9¾ lbs., the Magnemite* represents ease and convenience in remote recording.

Your Net Price . . . \$189⁵⁰
Complete with batteries, microphone, and earphones.

*Trade Mark Reg. Order today, or write for additional literature to:

AMPLIFIER CORP. of AMERICA · 398 Broadway · New York 13, N. Y.

Operate 2 sets from 1 Antenna with the

TELE MATIC ADD-A-SET TV Receiver Coupler

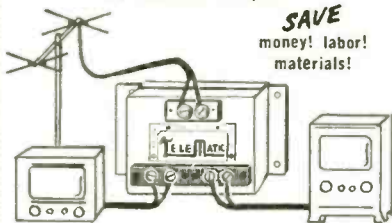

SAVE money! labor! materials!

- Highest efficiency transformers used.
- Operates in fringe areas.
- High pass filter action.
- No inter-set coupling.
- Eliminates soldering, screw terminal.
- Compact, mounts inside cabinet.

Sold by leading Jobbers Everywhere
Send for FREE booklet on TV INTERFERENCE



From the earliest days of Radio . . . to the present era of Television . . .

CORNISH WIRES

"Made by Engineers for Engineers"

CORNISH WIRE CO., Inc. — 50 Church St., N. Y. C. 7

New DRY BATTERIES

The Magnemite* uses inexpensive dry batteries that last 100 operating hours. No wet cells that require re-charging or special handling.

New SPRING MOTOR

The governor-controlled constant speed motor runs 15 minutes per winding.

New 2-HOUR RECORDING

This extended playing time is obtained because of 1½ in. per sec. tape speed, and the use of two sound tracks on standard 5 in. tape reels.

New SENSITIVITY

Crystal-clear recordings can be made from any distance up to 100 ft. away from the microphone.

WANTS PROTECTION

Dear Editor:

Maybe William C. Robertson of Va. (RADIO-ELECTRONICS, Oct. 1951, page 125) should read what is being done in other states by reading page 86, RADIO-ELECTRONICS, Aug. 1951.

Licensing seems to be the best way of protecting the owner of a TV set. A receipt showing the parts put into a TV set plus an itemized price for each part and signed by the repairman would for sure cut down large bills for replacing a 10¢ fuse.

Enjoy reading your magazine and sure I will continue.

WILFRED L. DUGAS

Issaquah, Wash.

PRAISE FROM ABROAD

Dear Editor:

I must write to say how much I have enjoyed the series of articles "Audio Feedback Design." It has been the most comprehensive treatise on the subject I have ever read in any paper. I hope due thanks are given to George Fletcher Cooper for the series.

For me, the November issue was outstanding as it contained full details of the Ionophone—on which some of the London daily papers had printed some very sketchy details only this week. Apparently the inventor had given a demonstration here in England during the weekend. The only knowledge I gained was that the speaker unit consisted of a glass tube which "had a blue glow which changed to pink on loud passages." This was fixed to a horn ten feet long with a mouth four feet square. I had tried every known source to get more details without any real success, when, (I might have known it all along!) RADIO-ELECTRONICS arrived with the full details and the promise of more to come!

I take three American radio journals by subscription (including an audio specialist) and two British, but there is no doubt, your paper has the rest beaten to a frazzle, both for audio and in the wider field of electronics. It is a happy combination of theory and practice in the most practical form.

EDWARD T. LEA

London, Eng.

FAVORS CONVERSIONS

Dear Editor:

Just finished reading Mr. Lehtreck's letter and am not happy to think that any one would want to hurt so many people by asking that you drop the TV Conversion material. I find that there is more demand now than ever before. I would rather have a suit that fits than a mess of hit-and-miss schematics that make you spend a lot of time wondering what is wrong with the article and how to fix it. Keep on printing all you have for a lot of us are slow but sure.

T/Sgt. JAMES E. WOLFE

Harbor Field, Md.

"FEB. SPECIAL" . . . PORTABLE CODE PRACTICE SET—USE OUTDOORS—INDOORS! Self-contained batt. operated (2 "D" cells). Polymahog. cabinet (7¼"x8"x4") . . . \$7.95
Crystal Diodes . . . 1N23—69c, 10/56.50; 1N23—51.29, 10/51.00
Radio Hardware Treasure FULL LBS. of Nuts, Screws, Washers, Lug, etc. . . . 69c 3 lbs./\$1.98

Leotone

HS-33 Headsets . . . 10-Z, 5' cord, PL-55 . . . \$2.49
ANS-H-1 Phone Units . . . 300 ohm Imped. . . .98
SWITCH SPECIALS! . . . DPDT BAT TOGGLES (Altho. 6A/125V; 49c 12/5.49
mic. Lug Term.49c 12/5.49
Rotary Switches . . . 2 deck, ¼" shaft—3 pos. DP or 6 pos. SP1.98
DPDT Flush Plate Bat Toggle (C-1) —N715K21 Lum. tip, 1¼" mic. . . .59c 6/3.25
SPDT Slide Switch . . . 3A/125V . . .19c 6/1.00

Power Rheostats . . . 25W-250 ohm, moisture-proof housing . . . 98c 8/55.00
50 Watt-15 Ohm (IRC) Rheostat1.29
Ornamental Metal Grille BEAUTIFUL ANY CABINET OR HAFFLEH Gold finish 18" round (2"x36") 12x12—\$6c 14x14—\$1.59; 14x18—\$1.39; 18x18—\$1.98; 18x24—\$2.69; 24x243.75
Grille Cloth . . . Beautiful GOLD or SILVER design . . . sq. ft. 35c sq. yd. 2.98
W-110B Field Wire . . . ORIG. STEEL REELS, 15 Mile (80 lbs.), \$8.95; 1 mile (160 lbs.), 17.50
Experimental Tubes . . . For Test, Research, Schools, Etc., tested, 40 asstd, reviv. 1950s. 1.98
Radio Screws . . . 3/32"x1", bronze, doz. 19c 100 1.25
Radio Builders Library . . . for Hams, Servicers, Students—15 asstd. B cast & SW set diagrams, High Fidelity Crystal Mike . . . hi-imped. Rubber shock-mtd. 1¼"x1¼". Less housing . . . 1.29
Aluminum Housing for crystal mike . . . 15
Tube Cartons . . . Plain white, Price per 100: Min. (11x122½) —\$1.20; GT (1¼" sq-x3¼") —\$1.45; Med. (1½" sq-x4¼") —\$1.65; Large (2x2x3) —\$1.98; Extra Large (2¼" sq-x6½") . . . 3.59
HBRGAIN KITS! . . . HUBRO RADIO PARTS KIT—17 FULL LBS. of COILS, WIRE, RESISTORS, CONDENSERS, SOCKETS, SWITCH, CHASSIS, ETC., ETC. Shpg. wt. 21 lbs. . . . 3.95
Speaker Cones . . . 4" to 12" Incl. free-edge. Less voice coils. 12 asstd. . . . 1.98
Speaker Repair Kit . . . Liberal assortment of Spiders, V.C. Forms, Felt, Rings, Chamois Lthr., Cement, Shim KIT & Instructions. ALL FOR 2.49
HBOYH "CONE & REPAIR" KITS! FOR ONLY 3.95
Terminal Boards . . . Incl. screw type. 10 asstd. . . .98
Moulded Bakelite Condensers—00001 to 2mf. 200-600V. Kit of 50 asstd. . . . 1.98
Rotary Selector Switches . . . Multi-deck, multi-contact. Kit of 6 asstd. . . . 1.75
Water Sockets . . . 4 to 8 pin. Kit of 12 asstd. . . .49

(WRITE FOR "ALNICO MAGNET" SUPPLEMENT)
FACTORY SPEAKER REPAIRS SINCE 1927
Min. Order \$3.00 . . . 20% deposit on all COD's
Please add sufficient postage—excess refunded
Full remittance with foreign orders

LEOTONE RADIO CORP.

67 Dey Street
New York 7, N. Y.

Another Outstanding Jobber

Almo Radio Co.

4401 Ventnor Ave., Atlantic City, N. J.

has all 17 KITS & INSTRUMENTS in stock!

950K R.C. BRIDGE & R.C.L. COMP. KIT \$19.95 See EICO ad on Page 20

DR. VAN DEN BOSCH WRITES

Dear Editor:

I have received a number of letters asking more information on certain points in my November article on the use of ultrasonics. The following will answer most of these queries:

The frequency most commonly used is 1 megacycle, though some manufacturers have included a supplementary frequency of 3 mc.

The tank circuit of the oscillator shown in the article consists of an inductance wound on a 2-inch form with 60 turns of No. 14 (smaller sizes will also do) wire at the rate of 10 turns per

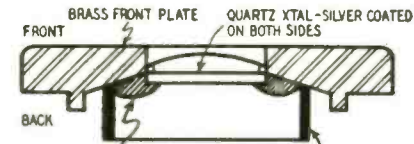

Fig. 1—Transducer for body application.

inch. The copper wire need not be silvered but it is advisable to have some form of slider to adjust the number of turns (on the spiral tuning principle) for the maximum oscillator output. A 60- μ mf variable capacitor bridges this inductance and the transducer head is paralleled with this capacitor.

The frequency of maximum power output is about 1 mc if the transducer head shown in Fig. 1 is used. The brass front plate transmits the vibrations with little attenuation. Drawing is exactly half actual size.

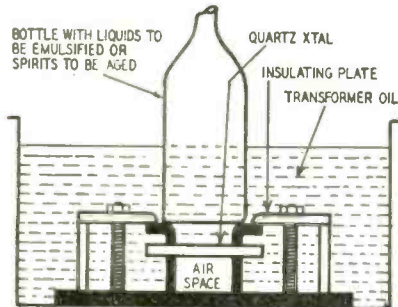

Fig. 2—Emulsions can be made and experiments performed with this circuit.

Sometimes a water bath is used to couple the vibrator head to the human skin, to obtain a good acoustic contact. Often it is more convenient to apply the vibrator head direct to the body with only a film of liquid between them. Thus a watertight casing and a radiating face smooth enough to make intimate contact with the skin—even when it is moved to and fro across it—is required.

Since it is not essential to obtain the highest possible ultrasonic output, insulation requirements are not very severe and a flexible cable can be used to connect the transducer to the generator.

Fig. 2 is an arrangement for obtaining perfect emulsions (oil and water) or for aging wine or other applications. The drawing is self-explanatory. Please note that for efficient operation the air space indicated is essential.

F. J. G. VAN DEN BOSCH
Antwerp, Belgium

YOUR MONEY GOES A LONG WAY AT STEVE-EL!

FREE DIVIDENDS EXTRA 10% OFF ON 100 TUBES OR MORE . . . EXTRA 5% OFF ON 25 TUBES OR MORE

BRAND NEW STANDARD BRAND TUBES—
Individually Boxed and Guaranteed

0Z4	.59	6BN6	1.32	7J7	1.19
1A6	.89	6BQ6	1.44	7K7	1.19
1A7	.98	6C4	.76	7L7	1.09
1B3	1.02	6C6	.85	7Q7	.89
1L4	.74	6C8	.76	7T7	1.19
1B5 25S	1.09	6C8B	2.49	7Y4	.86
1H5	.89	6D6	1.09	7Z4	.84
1J6	.74	6D8	1.39	12A6	.79
1LA4	1.12	6F6	.88	12A8	.86
1LA6	1.12	6F8	1.49	12AL5	.65
1LC5	1.12	6H6	.76	12AT7	1.09
1LC6	1.12	6J5	.59	12AU6	.89
1LD5	1.12	6L6	1.09	12AU7	.96
1LN5	1.12	6L7	.81	12AV6	.79
1N5	.87	6K6	.66	12AV7	1.24
1R5	.82	6K7	.74	12AX7	.99
1S5	.79	6L5	1.39	12BA6	.79
1T4	.83	6L6GA	1.19	12BE6	.79
1U4	.79	6L7	1.19	12H6	.89
1U5	.78	6M7	.88	12J5	.79
1V2	.69	6Q7	.76	12K7	.79
1X2A	.96	6S4	.76	12Q7	.77
2A4G	.84	6SA7	.76	12SA7	.78
2A5	.84	6SF7	.99	12S17	.77
3A4	.89	6SG7	.89	12SL7	1.09
3Q4	.89	6SH7	.76	12SN7	1.09
3Q5	1.02	6SJ7	.79	12SQ7	.68
3S4	.88	6SK7	.79	12T7	1.03
3V4	.99	6SL7	1.19	14A7	.93
5U4	.65	6SN7	.88	14B6	1.03
5V4	1.10	6SR7	.72	14N7	1.07
5W4	.83	6SQ7	1.19	14R7	1.02
5Y3	.47	6T8	1.69	14W7	1.09
5Y4	.75	6V6	.86	1978	1.34
5Z3	.89	6V6GT	.86	1978	1.09
5Z4	1.12	6W4	.66	25A6	1.49
6A3	1.59	6W6	.89	25B6	.85
6AB7	1.39	6X4	.74	25W4	.88
6AC7	1.21	6X5	.96	25Z6	.74
6AF6	1.18	6Y6	.89	32L7	1.49
6AG5	.86	7A4	.89	35L6	.58
6AG7	1.59	7A5	.86	35Y4	.86
6AH6	1.49	7A6	.86	35Z4	.57
6AK5	1.49	7A7	1.92	35Z5	.57
6AL5	.68	7AD7	.89	47	1.34
6AR5	.72	7AF7	1.05	50A5	.96
6AS5	.67	7AG7	1.05	50B5	.86
6AS5	.99	7B5	.89	50C5	.72
6AS7	5.39	7B6	.89	50Y6	.99
6AT6	.68	7B8	.79	50Y6	.99
6AU5	1.59	7C4	.89	56	.66
6AU6	.76	7C5	.79	70L7	1.69
6AV6	.67	7C6	.99	77	.89
6BA6	.69	7E5	.99	80	.79
6BA7	1.16	7E6	.99	117Z3	.78
6BC5	.86	7E7	.99	2051	1.22
6BE6	.82	7F7	.99	117N7	1.29
6BG6	1.76	7H7	.96	117N7	1.29
6BH6	.86	7G7	1.21		

YOU CAN'T BEAT THIS FOR VALUE!

the famous
630 TV Chassis
World's Finest
TV RECEIVER

The New and Improved Super Famous "630" T.V. Chassis, is a 30 tube high quality television receiver (including 3 rectifiers) manufactured under license by the Radio Corporation of America. This chassis is the standard by which all other T.V. chassis are measured.

Standard R.M.A. Guarantee FREE replacement on all defective tubes and parts.

FEATURES: • Full channel coverage • Discriminator-type FM sound system • Improved picture brilliance • AFC horizontal hold • Keyed AGC • Stabilized vertical hold • 3 stage sync. separator and clipper • Automatic brightness control • 4 Mc band width • Highest quality parts used. All standard tubes • For all Cathode Ray tube sizes and types. 16", 17", 19", 20", 24" Tubes. Perfect for Fringe Area Reception.—Will work where most sets fail to operate.

With HiGain standard coil tuner and R.C.A. Hi-Fi 12" Speaker, complete with knobs and hardware. Complete with Fed. Taxes Paid. Less Cathode Ray Tube **\$141.50**

630 DX Chassis—Extra power for fringe areas. Can be operated without booster or complicated antenna. Complete with Fed. Taxes Paid. Less Cathode Ray Tube. **\$151.50**

Chassis Mounting Brackets when ordered with chassis \$4.95

TV PICTURE TUBES

All black faced—Non glare. SHELDON, ZETKA, and other famous makes. All Guaranteed.

10BP4	\$21.95	17BP4	\$22.90
12LP4A	22.95	17HP4	24.95
14BP4	21.95	19AP4	32.95
16HP4	28.95	19EP4	39.50
16KP4	30.95	20CP4	32.95
16GP4	32.95	24AP4	65.50
16LP4			

FREE CATALOG OF TV ANTENNAS, CABINETS, PARTS, ACCESSORIES.

Terms: 20% cash with order, balance C.O.D. Prices F.O.B. N. Y. City Warehouse.
Min. order \$5. (Allow for postage). Prices in this ad supercede all others published.

Webster Chicago Automatic Record Changer Series 100

Plays 12, 10 or 7 inch records at 33 1/3, 45 or 78 R.P.M. New spindle carefully lowers unplayed record stack. Balanced arm assures light needle pressure or micro-groove records. Needle-tip (included) for standard without any adjustment. Inside-out records played position after last record has played. Complete factory packed and sealed record changers.

List Price **\$47.50** LIMITED QUANTITIES **\$24.79** OUR PRICE

STEVE-EL ELECTRONICS CORP. VISIT OUR NEW STORE

Dept. **E-2** 61 Reade St., New York 7, N. Y. COrtlandt 7-0086

The New

Mandl's Television Servicing

● gives you detailed, illustrated trouble-shooting procedures for every flaw or failure you're likely to encounter.

A COMPLETE MASTER INDEX and separate lists of trouble symptoms for each circuit defect make it easy to locate any particular trouble and the exact procedures for correcting it. Unusual, hard-to-find flaws as well as all common trouble are dealt with.

THE LATEST CIRCUITS are explained and illustrated, including servicing techniques for UHF and VHF.

ORIGINAL PHOTOGRAPHS show actual symptoms that appear on the TV screen when defects occur. Hundreds of circuit diagrams, illustrations of station defects, scope patterns, and other illustrations aid in the identification and location of circuit faults

and these are only a few of the features that make this the most helpful, practical, and complete service manual yet to be published.

Are these outstanding radio & TV aids on your working reference shelf?

Radio and TV Mathematics

by Fischer. Step-by-step solutions for hundreds of typical problems, arranged under radio and electronic headings for quick reference. Shows what formulas to use, what numerical values to substitute, how to solve each.

Television for Radiomen

by Noll. Very clear, non-mathematical explanation of all principles and full instruction on installation, alignment, adjustment, and trouble-shooting.

Television & FM Antenna Guide

by Noll & Mandl. A basic course on theory plus a complete handbook on all types of antennas and installation procedures.

Movies for TV

by Battison. Practical information on all equipment and experienced advice on the do's and don'ts of making newsreels, commercials, features, titles, special effects, cartoons, etc.

SEE THEM ON APPROVAL

The Macmillan Co., 60 5th Ave., N. Y. 11

Please send me copies of the books checked. I will either remit in full or return the books in 10 days.

- Mandl's TV Servicing \$5. (prob.) Signed
- Radio & TV Math. \$6.75
- TV for Radiomen \$7.75 Address
- TV & FM Antenna Guide \$6.25
- Movies for TV \$5.00

RADIO SCHOOL DIRECTORY

TELEVISION

Big demand for graduates

B.S. degree in 27 mo. in radio including TV engineering—VHF, UHF, AM and FM. New TV lab. Over \$100,000 worth of equipment. Also new modern physics lab. Intense specialized course includes strong basis in mathematics, advanced design in radio and in TV.

Hundreds of young men each year are earning engineering degrees in this recognized institution. Start any quarter. Many earn a major part of expenses in this industrial center. Low tuition. Competent instruction. Thorough, intense, practical program.

Also B.S. degree in 27 mo. in Aeronautical, Chemical, Civil, Electrical and Mechanical Engineering. Approved for veterans. Enter March, June, Sept. and Dec. Send for free catalog. **ENROLL NOW**

INDIANA TECHNICAL COLLEGE
1722 E. Washington Blvd., Fort Wayne 2, Indiana

ATTENTION...

A NEW department of the DON MARTIN SCHOOL OF RADIO AND TELEVISION ARTS AND SCIENCES . . . for instruction and training in—TELEVISION—incorporating:

Production: Writing, Directing, Producing, Acting, Staging, Lighting.

Engineering: Transmission, Receiving, Camera and Studio, Operation, Theory of Video, Pickup and Reproduction.

Approved for veterans.

THE DON MARTIN SCHOOL OF RADIO AND TELEVISION ARTS AND SCIENCES

1655 No. Cherokee, Hollywood 28, Calif. HU. 23281.

Unlimited Opportunities in RADIO ENGINEERING

DEGREE IN 27 MONTHS

Complete Radio Engineering course including Telev. U. H. F. and F. M. Bachelor of Science Degree also in Mech., Civil, Elect., Chem., and Aero. Eng.; Bus. Adm., Acct. Extensive campus, modern buildings, well equipped labs. Low cost. Prep courses. Personalized, practical instruction. Founded 1884. Placement service. Growing shortage of engineers. Prepare now for unlimited opportunities ahead. Enter, September, January, March, June. Write for catalog.



TRI-STATE COLLEGE

2422 College Ave. ANGOLA, INU.

RADIO ENGINEERING

FM—Television—Broadcast

Police Radio, Marine Radio, Radio Servicing, Aviation Radio and Ultra High mobile applications. Thorough training in all branches of Radio and Electronics. Modern laboratories and equipment. Old established school. Ample housing facilities. 7 acre campus. Small classes, enrollments limited. Our graduates are in demand. Write for catalog.

Approved for Veterans

VALPARAISO TECHNICAL INSTITUTE
Dept. C VALPARAISO, INDIANA

AUDIO (SOUND) ENGINEERING COURSE HOME STUDY TRAINING

Prepare yourself, in your spare time for a BIG PAY JOB as an AUDIO ENGINEER. Practical, easy-to-understand lessons, written by nationally recognized Audio Engineers and Educators.

Prepare for a SUCCESSFUL CAREER in the TELEVISION, RADIO, DISC AND TAPE RECORDING, ELECTRONICS AND MOTION PICTURE INDUSTRIES.

Training will not interfere with present employment.

EARN WHILE YOU LEARN
WRITE FOR COMPLETE DETAILS—TODAY

B. M. Klekner, D.Sc., Ph.D.

President

HOLLYWOOD TECHNICAL INSTITUTE
3359 Cahuenga Boulevard
Hollywood 28, California

LEARN TELEVISION

ELECTRONICS and RADIO
Engineering Laboratory and Classroom Training. Day and Evening Classes.

Write for illustrated Catalog

ELECTRONICS INSTITUTE, Inc.
21 HENRY, DETROIT 1, MICH.

RCA RADIO and TELEVISION ELECTRONICS

Thorough Training For Men and Women in All Technical Phases
New Classes (Day & Eve.) Start MARCH 3, 1952
FREE PLACEMENT SERVICE FOR GRADUATES
For Free Catalog Write Dept. RC-52

RCA INSTITUTES, Inc.
A Service of Radio Corporation of America
350 WEST 4TH STREET NEW YORK 14, N. Y.

You can't beat

Radio-Electronics

for complete coverage of

RADIO, TELEVISION and AUDIO

BEGINNERS NEGLECTED?

Dear Editor:

I wish to take this opportunity to congratulate your editors on the swell job they have done with RADIO-ELECTRONICS. It has been a pleasure to follow the progress that has been made with this publication over the years and sincerely say that in my opinion they deserve a "Well Done."

The only thing that comes to mind in constructive criticism is the suggestion that, personally, I would like to see more articles of an elementary nature published. The idea behind this thought is to cater to the beginners in radio. These groups are the potential readers of tomorrow and we are neglecting them today in the technical magazines.

DR. WILLIAM H. GRACE, JR.
Bronxville, N. Y.

ALL KNOWLEDGE USEFUL

Dear Editor:

A letter from Mr. Robert O. Barg states that in his opinion articles on electronics in medicine, Geiger counters etc., are wasted space.

It may be of some interest to you to know that since 1939 I have been filing all articles—including the above-mentioned—in loose-leaf binders, whether they were of interest to me at time of issue or not.

This year I began servicing therapy equipment and have found some of these articles of great value to me. Perhaps next year I may need the information already filed on Geiger counters. I thank you for the variety of subjects.

May I however make a suggestion? Why not spread out your many ads so that each article, or at least the main subjects may be removed from the magazine without finding another good subject on the back of the page?

W. G. MCKAY

Moose Jaw, Saskatchewan.

LEE DE FOREST WRITES

Dear Editor:

I have read with keen interest your editorial "Is the Vacuum Tube Doomed?" in the December issue. I think you have handled this situation with much wisdom and foresight.

I would be among the first to admit the advantages of the transistor in all situations where considerations of size and everlasting life are dominant. Not having had any personal experience with the transistor as yet, I am unable to compare its noise quality with that of a corresponding audion tube. I would judge from what I read that the transistor is much more noisy.

You justly point out that for many years to come vacuum tubes by the millions will be in demand, and when it comes to high-power transmitter applications, I see as yet no possible competitor to the three-electrode tube.

You are quite right that the name "transistor" is not a popular one. I think your suggestion of "crystron" is an excellent one.

LEE DE FOREST

Los Angeles, Calif.

—end—

Heavy on experience—light on theory?

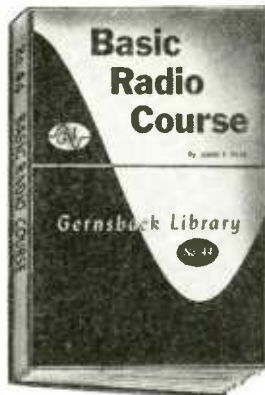

A "different" technical book!

BASIC RADIO COURSE differs from any other technical book on fundamentals. Every chapter is spiced with plenty of good laughs. That makes learning easier—and makes what you've learned stick longer. Any sound educator will tell you that! There's one other point where this book differs from high-domed, straight-faced technical books—the price! It gives you all the information any other book does—at a fraction of the cost. Get your copy today! Gives you a clearer understanding of the theory behind your work.

TWENTY-SIX BIG CHAPTERS

Covers:—Electron Theory • Ohm's Law • Resistance • Inductance • Capacitance • Reactance • Impedance • Resonant Circuits • Transformers • Tubes • Sound and Loudspeakers • Power Output Stage • Voltage Amplifiers • Demodulating the R.F. • Selectivity • Oscillators • Service Techniques • Many other important subjects.

Basic Radio Course by John T. Frye

Answers all your questions on fundamentals from Ohm's Law to advanced service techniques
Completely • Humorously • Economically

176 Pages 120 Illustrations
Only \$2.25

Popular writer, John T. Frye, himself a 25-year veteran in servicing, clears away every bit of haze that may cloud your knowledge of why tubes, capacitors, resistors and other components act as they do in radio circuits. He packs every single chapter with the kind of information that will make you know and understand what you're doing instead of just guessing or following formula.

Order your copy from your distributor or MAIL THIS COUPON TODAY

Radcraft Publications, Inc., Dept. 22
25 West Broadway
New York 7, N. Y.

My remittance for \$2.25 is enclosed. Please send me a copy of Book No. 44, BASIC RADIO COURSE postpaid.

NAME _____

STREET _____

CITY _____ ZONE _____ STATE _____



LIGHTNING ARRESTOR

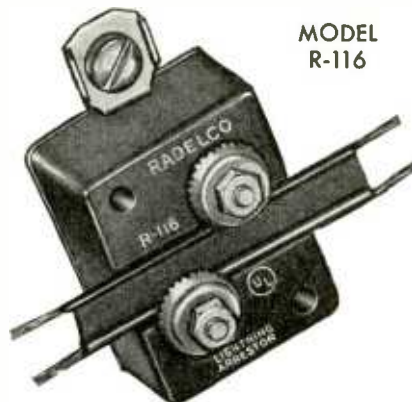

MODEL R-116

IT'S THE LOWEST PRICE UNDERWRITERS' LISTED ARRESTOR ON THE MARKET

ORDER FROM YOUR NEAREST PARTS JOBBER

LIST PRICE **90¢**

AUDEL'S TV SERVICE TELLS HOW TO SOLVE TV TROUBLES AND ANSWERS TV QUESTIONS

AUDEL'S TELEVISION SERVICE MANUAL covers T.V. information at your finger ends. Shows good receiver adjustment and How to Get Sharp, Clear Pictures, How to Install Aerials—Avoid Blurs, Smears, Interference and How to Test. Explains Color Systems and Methods of Conversion. IT PAYS TO KNOW! Over 380 PAGES & 225 ILLUSTRATIONS explaining operating principles of Modern Television Receivers;

Just Out!



1001 FACTS 19 CHAPTERS

Placement of Television Receivers—Receiver Controls; Test Patterns & Adjustments—Television Interference—Interference Traps—Television Antennas & Transmission Lines—Master Antenna Systems—Antenna Installation Procedure—Television Broadcasting—Television Receiver Fundamentals—Circuit Description of Typical Receiver—Television Picture Tubes—Projection Type Receivers—Television Testing Instruments—Television Servicing—Trouble Shooting—Color Television—Television Terms.

\$2 POST PAID

7 DAYS FREE TRIAL
GET THIS PRACTICAL ASSISTANCE FOR YOURSELF
MAIL COUPON TODAY

AUDEL, Publishers, 49 W. 23rd St., N. Y.
Mail me postpaid for 7 Days examination
AUDEL'S TELEVISION SERVICE MANUAL (Price \$2).
If O.K. I will mail you \$2, otherwise I will return book.

Name _____

Address _____

Employed by _____ TV-14

SPECIAL!! 6 TUBE AC-DC KIT

At Last! A low-priced kit designed for high sensitivity, excellent selectivity and good tone quality. Uses 25L6, 25Z6, 6SQ7, 6SA7, 6SK7, 6SK7 in an easily constructed circuit. The 6 Tube Kit is shipped with all parts, including punched chassis, resistors, condensers, coil, sockets, PM Speaker, hardware, etc.
 And at a closeout price of only **\$6.95**
 X162 less tubes and cabinet
 X183 Extra for matched set of six tubes for kit **\$3.25**

5 TUBE AC-DC SUPERHET KIT

Five tube superheterodyne kit, A.C.-D.C. contains all components required to construct this latest design, highly sensitive superheterodyne broadcast receiver complete with black bakelite cabinet (excludes wire and solder) Price \$7.95
 Extra for a kit of 5 tubes (12A6, 12BA6, 12BE6, 35WA, 50C5). Price \$3.25.

YOUR MONEY RETURNED IN FULL—

If the New Regency Television Booster fails to improve your television enjoyment! Bring your picture out of the snow and reduce interference!
 • Push-Pull Neutralized triode design assures high gain without adding snow.
 • No external impedance matching devices required.
 • Inductive tuning assures some high-gain wide-band operation on all channels.
 • Single knob tuning control.
 • Underwriters approved with 90 day RMA guarantee.

LOWEST Price—ONLY **\$19.11**

MODEL NFRD—RADIO NOISE FILTER

If it doesn't work, send it back!

We absolutely guarantee that our Model NFRD will eliminate all line noises when properly connected to radios, television sets, short wave sets, motors, electric shavers, refrigerators, vibrators, oil burners, transmitters, and all other sources of interference. This unit will carry up to 12 amperes or 1 1/2 KW of power and may be used right at the source of interference or at the radio.
 Small size only 2 1/2"x1 3/4"x4 1/2". Very low price only Each **\$1.95**

A SCIENTIFICALLY DESIGNED PHONO SCRATCH FILTER

Resonated at approximately 4500 cycles effectively reducing objectionable needle scratch without altering the brilliancy of reproduction.
 Contains a HI-Q SERIES resonated circuit. Tested by means of an audio oscillator and an oscilloscope to give 22 db attenuation with very low signal loss.
 EASY TO ATTACH
 Just two wires to clip on. Compact Price **\$1.98**

THREE TUBE PHONO AMPLIFIER

An assembled unit ready for installation using tone and volume control and six feet of rubber cord **\$2.95**
 (Not including Tubes)
 With Complete Set of Tubes.....\$3.95

PHONO OSCILLATOR

Wireless phono oscillator transmits recording for crystal pick-ups or voice from carbon mike through radio without wires. Can also be used as an intercomm by using P.M. speaker as mike. Price (excluding tubes) **\$2.95**
 With Complete Set of Tubes.....\$3.95

Grab Bag Special. 10 pounds of Misc. Electronic Material—Transformers, Condensers, resistor, wire, etc. Price \$1.95 ea.

Satisfaction guaranteed on all merchandise. All prices subject to change without notice.

RADIO DEALERS SUPPLY CO.

54 Greenwich St. New York 6, N.Y.

FUNDAMENTALS OF ELECTRONICS, by F. H. Mitchell. Published by Addison-Wesley Press, Inc., Cambridge 42, Mass. 6 x 9 inches, 243 pages. Price \$1.50.

This is a basic course for readers who are familiar with Ohm's law and elementary algebra. Little math is used. The text is clear and informal. Photographs, graphs, worked examples and numerical problems (with answers on last page) are included.

The first chapters describe simple d.c. and a.c. circuits and components. Then the subject of tubes is covered in some detail. Emphasis is placed on characteristic curves and how to use them. In this connection a separate 8-page folder provides large-size curves of typical tubes.

Specialized tubes such as thyratrons, Geigers, electrometers, and others, are described. Wave-shaping and trigger circuits are also included. The last chapter is an interesting study of the electronic voltmeter and cathode-ray oscilloscopes.

STATIC AND DYNAMIC ELECTRICITY (Second Edition) by William R. Smythe. Published by McGraw-Hill Book Co., Inc., 330 W. 42 Street, New York, N.Y. 6 x 9 inches, 616 pages. Price \$8.50.

This text is written for first-year graduate students in physics and electrical engineering. The reader should have a good knowledge of calculus and vector analysis. Various mathematical functions are developed as they are needed. All equations are based on MKS units.

With each subject the author first derives basic theory and equations. Then he shows how to apply them to practice. In this way he develops a knowledge of transformers, filters, antennas and wave guides, among other subjects.

ELECTROMAGNETIC WAVES AND RADIATING SYSTEMS By Edward C. Jordan. Published by Prentice-Hall, Inc., 70 Fifth Ave., New York, N.Y. 5 1/2 x 8 1/2 inches, 710 pages, Price \$10.50.

This book has been prepared as a course for electrical engineers and physicists. The first part is suitable for college seniors. Later chapters are written at a graduate-student level. There is much to recommend the volume to readers who wish to advance or review their knowledge of waves and radiation. A good knowledge of calculus and algebra is needed. The author develops other special material as required.

The text is outstanding in several respects. The subject is analyzed extensively and without unnecessary rigor. Each chapter ends with numerical problems based on the theory.

The first three chapters deal with vector analysis, electrostatics and magnetic fields. The next derives Maxwell's equations. This is followed by material on waves along transmission lines, through guides and from antennas. A chapter on antenna practice and design covers dipoles, rhombics, end-fire arrays and others.—IQ

OPPORTUNITY AD-LETS

Advertisements in this section cost 35c a word for each insertion. Name, address and initials must be included at the above rate. Cash should accompany all classified advertisements unless placed by an accredited advertising agency. No advertisement for less than ten words accepted. Ten percent discount six issues, twenty percent for twelve issues. Objectionable or misleading advertisements not accepted. Advertisements for April issue must reach us not later than February 21, 1952. Radio-Electronics, 25 W. Broadway, New York 7, N. Y.

RADIO Officers. \$7,200-\$10,000 annual earnings. top union conditions. 6 months Radio Operating experience (US Merchant ships on FCC License since Jan. 1, 1935, can get emergency FCC License in suit at once. Also experienced USN Radiomen with 2d class Radiotelegraph license plus 6 months sea Radio time. Phone, write, wire American Radio Association, C/O, 5 Beckman St., New York, CO 7-6397.

PLANS ALL WAVE RADIO USING HEARING AID parts. Send 25c. Glen Ecker, 10 East Orange Grove, Pasadena 7, Calif.

WE REPAIR, EXCHANGE, SELL, ALL TYPES OF electrical instruments, tube checkers and analyzers, Hazleton Instrument Co. (Electric Meter Laboratory), 128 Liberty Street, New York, N. Y. Telephone—Barelay 7-4239.

WANTED: AN/APR-1, other "APR", "ARR", "TS", "IE", "ARC-1, ARC-3, ART-13, everything Surplus. Special tubes, Tech Manuals, Lab quality Test Equipment, etc. Describe price in first letter. Littell, Parhills Box 26, Dayton 9, Ohio.

WANTED: THE FOLLOWING SETS, PARTS OR Equipment associated with: RC-61A Handie-Talkies; ARC-1, ARC-3, ARN-7; BC-342, 312; R-89B/ARN-5; T-47, 47A/ART-13 & Dynamotor; F-21/ARA-9 Audio Filter; RT-7A/APN-1; APN-2; APN-9; BC-318; MG 149; BC-733D; BC-996A; 1M 32A; BC-453B; CRT-3; 8CR-522; plus all types test equipment. Top Dollar paid. Write: ROBERT SANETT, 4668 Boekweller, Los Angeles, California

T.V. PICTURE TUBE ADAPTER—\$1.00. Instruction on how to build Adapter. Checks gas, emission, shorts. Send make and model of your tube checker. T.V. Research, 4101 E. 139 Street, Cleveland, Ohio.

RADIO TEST TECHNICIANS and Radio Test Engineers for alignment test and trouble-shooting of complicated radio equipment. These jobs require thorough theoretical knowledge and extensive experience in practical radio. Pay is excellent (many technicians earn up to \$120.00 a week), working conditions are of the finest, opportunities for advancement are good, and you'll like the employee benefits. All this plus the opportunity to work in the finest city in the Midwest! Write for an interview or send resume of qualifications to R. V. Mayrhauser, THE TURNER COMPANY, 909 17th Street N.E., Cedar Rapids, Iowa.

AMATEURS—RADIO ENGINEERING QUESTIONS Answered \$1.00 With Schematics \$2.50. Henry Twilman, R. R. #1, Chesterfield, Missouri.

TV AND FM ANTENNAS, YAGI, CONICAL, BOW-TIE, Mounts, accessories. Lowest prices. Wholesale Supply Co., Lunenburg 2, Mass.

New! Up-to-date!

TELEVISION SERVICING

by Walter H. Buchsbaum



310 pages
170 Illustrations

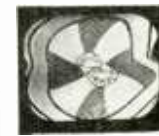

Symptoms of defective operation easily recognized, quickly corrected by Illustrations, diagrams and how-to-do-it facts in this new book.

Get this brand new, complete handbook for sure-fire working knowledge of TV installation, maintenance and troubleshooting. Tells you step-by-step procedures for audio IF alignment, video IF alignment, aligning RF amplifiers, mixers, oscillators, etc. All possible defects classified for ready reference, thoroughly analyzed to show what is wrong and why . . . and what to do to correct the defect. No mathematical knowledge needed! Practical, authoritative, up-to-the-minute, the perfect handbook for set owners, trainees, and repairmen.

USE IT 10 DAYS FREE

Coupon below brings you "Television Servicing" on FREE trial for 10 days, without obligation. Mail it NOW.

PRENTICE-HALL, Inc., Dept. M-RE-252
 70 Fifth Ave., New York 11, N. Y.
 Send me, for 10 DAYS' FREE TRIAL, "Television Servicing." I will return it in ten days and pay nothing—or keep it and send \$1.35 down (plus postage) and \$2 monthly for 2 months.
 NAME.....
 ADDRESS.....
 CITY..... STATE.....
 SAVE! Send \$5.35 with this coupon, and we'll pay postage and packing.

PULSES AND TRANSIENTS IN COMMUNICATION CIRCUITS, by Colin Cherry. Published by Dover Publications, Inc., 1780 Broadway, New York 19, N. Y. 5 1/2 x 8 inches, 336 pages. Price \$3.95.

This is a logical introduction to pulses for TV and radar engineers. It is a theoretical work, but advanced mathematics is avoided. Instead, the author relies mainly on physical concepts to tell his story. Graphs and waveform illustrations are used profusely. However, the reader must know elementary calculus, algebra and trigonometry.

The book starts with sinusoidal waveforms, then goes into complex waves. Waves are considered as composed of conjugate components, having both positive and negative frequencies. AM, PM, FM, square waves, and many others are analyzed. Subsequent chapters deal with dual circuits, filter networks and multistage amplifiers (without negative feedback). The last chapter deals with delay lines and includes a study of echoes on transmission lines.

To encourage further study, appropriate references are listed at the end of each chapter.—*IQ*

TV AND ELECTRONICS AS A CAREER, by Ira Kamen and Richard H. Dorf. Published by John F. Rider Publisher, Inc., 480 Canal St., New York 13, N. Y. 5 5/8" x 8 5/8", 326 pages. Price \$4.95.

Those of us who have been in radio for a long time are inclined to forget that each year brings out a new crop of young boys who look at electronics with bug-eyed awe and wonder how and where they can fit in. This book tells them. Analyzing the field of electronics (and a wide, wide field it is) it gives the background scene of television broadcasting, AM, FM, communications, radio and television manufacturing, electronic engineering, television servicing, distribution, and electronics in the armed forces.

As an added fillip to whet the ambition of would-be technicians, the book includes a chapter on ultra-successful men in the industry. A good bit of vocational guidance, and very nicely illustrated.—*MC*

TELEVISION INTERFERENCE, a collection of reprints of articles written by Phillip S. Rand. Published by Remington Rand, Inc., 315 4th Ave., New York, N. Y. 8 1/2 x 11 inches, 80 pages. Price: free to all amateurs, 25c to others.

The book consists of reprints of 14 articles on TVI written by Phillip Rand, W1DBM, and published in such magazines as *CQ*, *QST*, and *Electronics*. In each of the articles, the author (known to active hams and SWL's as One Double-Button Mike, and recognized by them as the authority on TVI prevention) describes practical methods of eliminating harmonic radiation from transmitters, diathermy machines, and industrial heaters.

Several of the articles also include discussions of traps and filters which may be used at the receiver to prevent strong fundamentals from entering it on the antenna lead-in or power line.

Practical, Popular-priced Books on
RADIO•AUDIO•SERVICING



A NEW BOOK ON RADIO TUBES!

RADIO TUBE FUNDAMENTALS—No. 45. By George J. Christ. 96 pages, 74 illustrations. Just off the press—the first and only low-priced book to give you such a complete picture of the how, what and why of radio tubes—the heart of any set. The author, an engineer and teacher, gives the radio man the information he wants about tubes in the way he's accustomed to using it. Here's a practical book that will increase your understanding of radio whether you're a 25-year man or just starting out. Covers tubes from the electron theory to a working analysis of the different types of tubes. You'll find this new Gernsback Library Book as valuable as your soldering iron! Order your copy today. Only \$1.00.

TWO TOP-FLIGHT \$1.00 BOOKS

MODEL CONTROL BY RADIO—No. 43. By Edward L. Saford, Jr., 112 pages. An authority in the field of radio control gives you the first complete book on the subject. For beginner and expert. Tells you what radio control is, how it works and how to construct not only component parts but a complete system as well. Illustrations explain each step.

HIGH-FIDELITY TECHNIQUES—No. 42. By James R. Langham, 112 pages. You've never seen a technical book like it! Just as he'd talk to you across the work bench, RADIO-ELECTRONICS' popular audio writer tells you how to design your own equipment and how to get top performance from it. Takes the double talk out of high-fidelity work.



THREE IMPORTANT 75¢ BOOKS



PUBLIC-ADDRESS GUIDE—No. 41. 80 pages. This handy book shows the service technician the way to extra income in big-paying PA work. Covers installation, maintenance and construction.

THE CATHODE-RAY OSCILLOSCOPE—No. 40. 112 pages. A "must" for servicing TV, FM and AM receivers and in amateur operation! Tells in simple, but technically sound language, how the 'scope works and how to use it.

PRACTICAL DISC RECORDING—No. 39. 96 pages. Tells you how to make good disc recordings. Covers every phase, theory as well as technique. A full chapter is devoted to each component.

6 POPULAR 64-PAGE BOOKS — 50¢ EACH

HANDY KINKS AND SHORT CUTS—No. 29. A treasury of time savers! Antennas, power supplies, test equipment, phonographs, amplifiers. Easy reference. Illustrated.

UNUSUAL PATENTED CIRCUITS—No. 30. A gold mine of important hook-ups. Control circuits, detectors, amplifiers, power supplies, foreign circuits.

RADIO QUESTIONS & ANSWERS—No. 31. Answers the tough ones on circuit diagrams, amplifiers, receivers, transmitters, meters and test equipment.

ADVANCED SERVICE TECHNIQUE—No. 32. A "must" for the advanced service technician! Covers specialized problems of servicing not usually found in ordinary textbooks.

AMPLIFIER BUILDER'S GUIDE—No. 33. For the designer and builder of audio equipment. Covers a variety of amplifiers with power outputs from 8 to 30 watts.

RADIO TEST INSTRUMENTS—No. 36. Practical construction data on signal tracers, capacity meters, portable and bench multi-checkers, voltmeters, etc.

THE GERNSBACK LIBRARY

SEE YOUR DISTRIBUTOR OR MAIL THIS COUPON TODAY

RADCPAFT PUBLICATIONS, INC.
25 West Broadway, New York 7, N. Y.

Enclosed is \$..... for which please send me postpaid, the books checked below.

- 29 30 31 32 33 36
 39 40 41 42 43 45

Name.....

Street.....

City..... Zone..... State.....

BE AN EXPERT

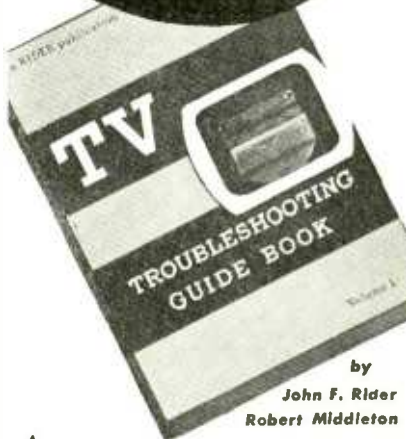

by
John F. Rider
Robert Middleton

A new, practical, easy-to-use book for the TV service technician. It tells you how to spot receiver troubles and correct them. Contains factual information right from the manufacturer, things you must know to be a TV troubleshooting and repair expert. The contents include: explanation of split-circuit and intercarrier receivers, circuit variations and how they affect operating waveforms, simplified TV receiver troubleshooting by scope and picture tube screen display analysis, remedies for circuit troubles, rapid methods of alignment and recognition of alignment problems. Not a theory book—but a practical, down-to-earth troubleshooting and repair guide.

200 pages, 8½" x 11"; durably bound.....\$3.90

ENCYCLOPEDIA ON CATHODE-RAY OSCILLOSCOPES AND THEIR USES

By John F. Rider and Seymour D. Uslan



This practical book tells you everything you should know about an oscilloscope! WHAT it is — what it can do... and HOW to use it properly! S. F. Patton, General Mgr. Ailton B. DuMont Labs., Inc. "...most elaborate treatment..." F. E. Smolek, Service Mgr., Zenith Radio Corp. "...most complete..." Radio Television Service Dealer. 992 pp., 8½" x 11", durably bound. \$9.00

FIRST SUPPLEMENT RECEIVING TUBE SUBSTITUTION GUIDE BOOK

By H. A. Middleton



An indispensable addition to your service library. Illustrates 650 completely new AM-FM-TV tube substitutions with socket wiring instructions. 48 pp., 8½" x 11".....\$.99
FIRST EDITION — 225 pp., 8½" x 11".....\$2.40

MAIL THIS COUPON — TODAY!

JOHN F. RIDER, Publisher, Inc. Dept. RE 2
480 Canal St., New York 13, N. Y.

Please send me book(s) checked. I understand, if not satisfied, I may return them within 10 days and receive full refund.

- TV TROUBLE SHOOTING GUIDE BOOK, \$3.90
- ENCY. ON C-R SCOPES AND USES, \$9.00
- RECEIVING TUBE SUB. GUIDE, \$2.40
- 1st SUPPLEMENT, \$.99

NAME.....(PLEASE PRINT).....

ADDRESS.....

CITY.....ZONE.....STATE.....



GENERAL ELECTRIC TV RECEIVER SERVICE GUIDE.

Published by General Electric Co., Electronics Park, Syracuse, N. Y. 11 x 17 inches, 80 pages. Price \$1.00.
Large enough so that you can read the circuit diagrams it contains, and spiral bound so that you don't need a 20-pound weight to keep the pages flat, this guide contains schematics of 102 G-E chassis, plus ten front ends used in 86 TV chassis. In addition, there are tube location charts, top and bottom chassis views, parts lists, and cabling diagrams on combination sets.—MC

TRANSMISSION LINES AND NETWORKS,

by Walter C. Johnson. Published by McGraw-Hill Book Co., Inc., 330 W. 42nd St., New York, N. Y. 6 x 9 inches, 361 pages. Price \$5.00.
This book requires a knowledge of elementary calculus and a.c. theory. Part I consists of nine chapters which deal with lines. The material is divided so that different chapters cover power lines, telephone lines and r.f. lines. The radio technician will be especially attracted to the chapters which describe r.f. lines, measurements and impedance matching. Traveling probes, lecher wires, bolometers and crystals, directional couplers and stubs are explained.

Part II has six chapters which deal with networks and filters. This part covers much less ground but the author shows how to design various lowpass, highpass and bandpass networks.

Throughout this text a number of examples are worked out in detail, step-by-step.

AMERICAN STANDARD ACOUSTICAL TERMINOLOGY.

Sponsored by the Acoustical Society of America in cooperation with the Institute of Radio Engineers. Published by the American Standards Association, Inc., 70 East Forty-fifth St., New York 17, N. Y. 8½ x 11 inches, 50 pages. Price \$1.50.

This American Standard (Z24.1-1951) is an authoritative dictionary of words and terms used in the language of the sound man and acoustical engineer. Among its 12 units, one is devoted to ultrasonics and one to underwater sound.

FOUNDATIONS OF WIRELESS (Fifth Edition),

by M. G. Scroggie. Published for Wireless World by Iliffe & Sons, Ltd., London. (American agents: British Book Centre, 122 East 55th St., New York 22, N. Y.) 8¼ x 5½ inches, 328 pages, Price \$2.75.
This radio primer has been completely rewritten. It is prepared by a radio writer of international authority. Theory and practice are treated as equally important, and the style is interesting and lively. Math is limited to a few simple equations and many graphs.

There are a total of 21 chapters, each dealing with some important aspect of radio, such as tubes, power supplies, a.f., selectivity, etc. The principles of television, radar, cathode-ray tubes, transmission lines and transmitters are also covered.—IQ
—end—



Special Offer On This Complete RADIO ENGINEERING LIBRARY

New, Up-To-Date Editions of Famous Library Covers Whole Field of Radio Engineering. Places Latest Facts, Standards, Data, Practice, and Theory At Your Fingertips

The five big volumes of the new edition of the Radio Engineering Library now include the very latest facts, standards, data, and practice. This Library will help solve hundreds of problems for designers, researchers, engineers, and students in any field based on radio.

Written by leading radio engineers, these books cover circuit phenomena, networks, tube theory, vacuum tubes, amplification, measurements, etc.—give specialized treatment of all fields of practical design and application. They provide you with a complete and dependable encyclopedia of facts.

- 5 Volumes, 3872 Pages, 2770 Illustrations
- Eastman's FUNDAMENTALS OF VACUUM TUBES, 3rd Edition.
- Terman's RADIO ENGINEERING, 3rd Edition.
- Everitt's COMMUNICATION ENGINEERING, 2nd Edition.
- Hund's HIGH FREQUENCY MEASUREMENTS, 2nd Edition.
- Henney's RADIO ENGINEERING HANDBOOK, 4th Edition.

SEND NO MONEY

Special Low Price—Easy Terms

On this special offer you get this Library for \$34.50, instead of \$39.00. You save \$4.50 and may pay on easy terms. Mail coupon below to examine the Library FREE for 10 days. No obligation. These books are recognized as standard works; you are bound to need them. So take advantage of this special money-saving offer. Mail coupon at once!

McGraw-Hill Book Co., Dept. RE-252
327 West 41st St., New York 18, N. Y.
Send for 10 days' FREE trial, the RADIO ENGINEERING LIBRARY. If not satisfied I will return books. Otherwise I will send \$4.50, plus delivery charges, then; and \$3 a month for 6 months. (Reg. price \$39.00; you save \$4.50).

Name

Home Address

City & State

We'll Pay Delivery Charges if you enclose \$4.50 first payment WITH coupon. Same return privilege for full refund.

SPECIAL MOTORS

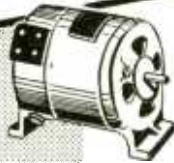

SELSYNS



DYNAMOTORS



POWER UNITS

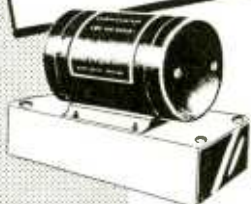

BLOWERS



THIS EQUIPMENT IS THE FINEST AVAILABLE, BUILT BY LEADING MANUFACTURERS AND UNCONDITIONALLY GUARANTEED BY WELLS. MANY TYPES NOT LISTED ARE IN STOCK. SEND US YOUR REQUIREMENTS FOR IMMEDIATE QUOTATION.

MOTORS AND SELSYNS

MANUFACTURER	TYPE OR NO.	VOLTAGE	RPM	DIMENSIONS	SPECIAL INFORMATION
Stewart Warner		6VDC		2 1/4" x 2 3/4"	1/4" x 1/2" Lg. shaft
John Oster	B-9-2	12VDC 1.4A	5600	2 1/4" x 3 3/4"	1/4" x 1/2" Lg. shaft. Shunt Wd.
General Ind.	62800	13VDC 9A	6800	2 1/4" x 4"	1/4" x 3/4" Lg. shaft. 1/12 HP
Emerson	D-26-BT	24VDC 24A	100	2 1/4" x 5 1/2"	160 Ft.-Oz. torque
Redmond	7-N	24VDC .96A	6000	2 3/4" x 3 1/4"	Complete blower assembly
F. A. Smith	40H	115VAC 60 Cy	6" x 5 1/2" x 5"	100 CFM blower (\$12.95)
Western Elect.	FL	115VAC 400 Cy	6700	3 1/4" x 4" x 4 1/2"	25 CFM blower
Signal Elect.	D-4272	24VDC .66A	2100	2 1/4" x 2 1/2"	1/4" x 1" shaft. 1/190 HP
Stromberg	D-4496	24VDC .45A	2 1/2" x 3 1/4"	1/4" x 3/4" shaft. .003 HP
Anglo		24VDC	1 1/2" x 2 1/4"	Telephone ringing circuit motor
John Oster	A-16B-26R	26VDC	1 1/2" x 2 1/4"	1/4" x 1/2" shaft. Series Rev.
John Oster	DEST-8-1R	27VDC 1.4A	3800	2 1/4" x 4 1/2"	3/4" x 1/4" shaft. 1/40 HP
Delco	5069267	27.5VDC .25A	6000	1 3/4" x 2 1/2"	1/4" x 1 1/2" shaft. 1 1/2 Oz-In Tq.
Western Elect.	KS5996-LO4	28VDC	2" x 2 1/2"	1/4" x 1/2" shaft. Series Rev.
Bendix	M05B	28VDC 1.75A	3200	1 1/2" x 2 1/2"	1/4" x 1 1/2" shaft. Series Rev.
Bendix	E-11500-1	28VDC 1A	9000	1 1/2" x 2 1/2"	1/4" x 1 1/2" shaft. Series Rev.
Fractional Mtrs.	SH-280	28VDC 3.1A	3900	3 1/4" x 5 1/2"	1/4" x 3/4" shaft. Used in ART 13
Electrolux	20100	28VDC .1A	2" x 2 1/2"	1/4" x 1/2" shaft. 20 Deg. rotation
John Oster	A-21-E-12R	28VDC .4A	1 1/2" x 2 1/2"	1/4" x 3/4" shaft. Series Rev.
Emerson	D-26-BV	28VDC 3.1A	3900	2 1/2" x 3 1/2"	1/4" x 3/4" shaft. 1/20 HP
Electrolux	16876	28.5VDC 1.8A	2200	3 1/4" x 5"	1/4" x 1 1/4" shaft. 1/35 HP
General Elect.	2J1G1	57.5VAC 400 Cy	2 1/4" x 3 1/2"	Selsyn transmitter
General Elect.	5BN38HA10	80VDC .25A	3000	2 1/2" x 5 1/4"	1/4" x 3/4" lg. shaft
General Elect.	2J1F1	115VAC 400 Cy	2 1/4" x 3"	Selsyn generator
Diehl	11-1	110VAC 60 Cy	4" x 5 1/4"	Synchro repeater selsyn
Bendix	110VAC 60 Cy	3 1/4" x 5 1/2"	Synchro differential selsyn
Bendix	110VAC 60 Cy	3 1/4" x 5 1/2"	Synchro transmitter selsyn

DYNAMOTORS AND POWER UNITS

MANUFACTURER	TYPE OR NO.	INPUT	OUTPUT	DIA.	LGTH.	SPECIAL INFORMATION
Eicor	ML3415-254	27.5VDC 1.5A	250VDC .060A	4"	8 3/4"	With bracket mounting
Eicor	ML3412-42	13.8VDC 2.45A	220VDC .070A	3 3/4"	5 1/2"	No mounting
Western Elect.	DM53AZ	14VDC 2.8A	220VDC .080A	2 3/4"	4 1/2"	With base plate
Westinghouse	1171187A	27VDC 1.4A	285VDC .060A	2 1/4"	4 1/2"	No mounting
General Elect.	5DY82AB52	27VDC 1.5A	285VDC .060A	2 3/4"	4 1/2"	No mounting
Western Elect.	1171091B	27VDC 1.6A	285VDC .075A	2 3/4"	4 1/2"	No mounting
Redmond	5047	27VDC 1.75A	285VDC .075A	2 3/4"	4 1/2"	No mounting
Eicor	ML3415-254	27.5VDC 1.5A	100VDC .150A	3 3/4"	5 1/2"	With base plate
Eicor	ML3420-194	27.5VDC 4.0A	325VDC .200A	3 3/4"	6 1/2"	With base plate
C. Q. R.	355D2BA	27.9VDC 1.25A	220VDC .070A	3 3/4"	5 3/4"	No mounting
Continental	DM310A	28VDC .5A	100VDC .01A	2 3/4"	4 1/2"	No mounting
C. A. Y.	DM32A	28VDC 1.1A	250VDC .060A	2 3/4"	4 1/2"	With base plate
Pioneer	PE86M	28VDC 1.25A	250VDC .060A	2 3/4"	4 1/2"	With base and filter
Bendix	DA-1A	28VDC 1.6A	230VDC .100A	3 3/4"	5 1/2"	No mounting
Redmond	DM5 3A	28VDC 1.4A	220VDC .080A	2 3/4"	4 1/2"	With base plate
Redmond	5056	28VDC 1.4A	250VDC .060A	2 3/4"	4 1/2"	With base plate
Eicor	ML-3420-90	28VDC 3.3A	400VDC .125 A	3 1/2"	6 1/2"	With base plate
Continental	DM33A	28VDC 5A	575VDC .160A	3 1/2"	7 1/2"	Cont. duty. No mounting
Winco	41S6	13VDC 13A	250VDC .060A	4" x	8 3/4"	With base plate
		13VDC	300VDC .225A			Intermittent
Continental	DMX310A	12VDC 2.8A	150VDC .100A	2 3/4"	4 1/2"	Cont. Duty. No mounting
				DIMENSIONS		
Pioneer	PE 55	12VDC .16A	500VDC 0.2A	7 1/4" x 12 3/4" x 13 1/2"		Pwr. Unit W/DM 19G
			Cont.			DYN, Filter and Mounting
Westinghouse	PE 94C	28VDC 10.5A	300VDC .260A	8 1/4" x 6 1/2" x 12 1/2"		Pwr. Unit W/DA3A
			150VDC .010A			DYN, Filter and Mounting
			14.5VDC 10A			

ADEL CLAMPS — HUGE STOCK — SEND US YOUR REQUIREMENTS

CHECK WELLS' HUGE STOCK FOR IMMEDIATE DELIVERY OF QUALITY COMPONENTS AT SUBSTANTIALLY LOWER COST

- Resistors • Condensers • Wire and Cable •
- Co-ax Connectors • Rectifiers • Transformers • Chokes
- Micro Switches, Toggles • Antennas • Accessories
- Electronic Assemblies • Dial Light Assemblies

SEEley 8-4143

MANUFACTURERS AND DISTRIBUTORS: WRITE FOR CATALOG

ORDER DIRECT OR THROUGH YOUR LOCAL PARTS JOBBER

WELLS SALES, INC.

833 W. CHICAGO AVE., DEPT. Y, CHICAGO 22, ILL.

RADIO-ELECTRONICS for



'Way Out Front with Servicemen . . . everywhere !

MALLORY VIBRATORS

Servicemen know they get dependable, trouble-free performance from Mallory vibrators. That's why a recent survey showed Mallory vibrators the choice of servicemen by a 2 to 1 margin. Count on Mallory vibrators for . . .

- 1—Slow contact impact for minimum wear.
- 2—High contact pressure for low resistance.
- 3—Fast contact break for reduced arcing, pitting.

Mallory *alone* gives you that three-way vibrator combination because of its patented, tuned mechanism. It's your assurance of long-lasting service that beats the comeback problem. Set makers count on Mallory, too . . . they use more Mallory vibrators as original equipment than all other brands combined. When you order vibrators . . .



You get a Handy Parts Cabinet at no additional cost with Mallory's Special Vibrator Deals

You keep your inventory down . . . and get the parts cabinet, too . . . with these Mallory deals you can service 47 different makes of radios with the assortment of 6 Mallory vibrators. All this is yours at your regular discount price. See your distributor today.

Make Sure! Make it Mallory!

P. R. MALLORY & CO. Inc.

MALLORY

CAPACITORS • CONTROLS • VIBRATORS • SWITCHES • RESISTORS
• RECTIFIERS • VIBRAPACK* POWER SUPPLIES • FILTERS

*Reg. U.S. Pat. Off.

APPROVED PRECISION PRODUCTS

P. R. MALLORY & CO., Inc., INDIANAPOLIS 6, INDIANA

3287
1457
177.4

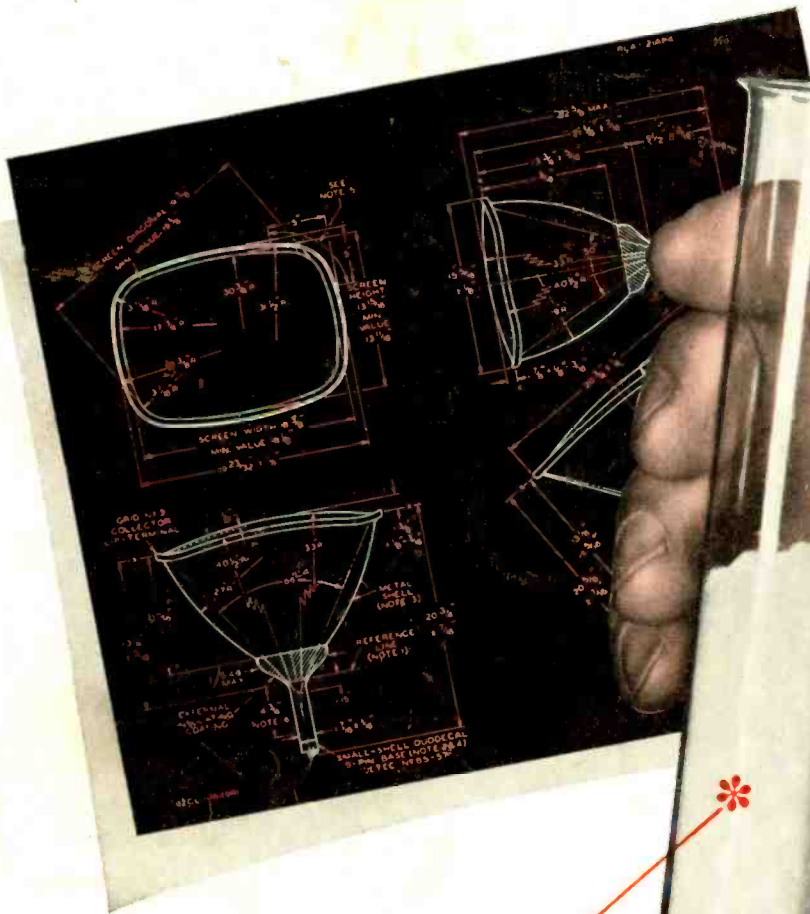

99 ⁹⁹/₁₀₀ %

pure phosphor . . . yet we threw it away

PURE by most standards, this batch of phosphor was discarded because it contained more than our prescribed limits of 2 parts in one million of copper salts . . . sufficient, in our experience, to impair the performance of the fluorescent screen of a picture tube.

To avoid any such occurrence, every process in the manufacture of RCA picture tubes is closely guarded . . . from the control of raw materials to the final

evacuation and sealing operations.

By exercising rigid control over every step in production, RCA has achieved the exceptional quality for which RCA picture tubes are noted . . . a quality that is unmatched for reliability and uniformity.

In RCA picture tubes, the difference is TOP-QUALITY CONTROL. That's why —dollar for dollar—RCA picture tubes have no equal.



RADIO CORPORATION of AMERICA
ELECTRON TUBES
HARRISON, N. J.

ADV Plans, LLC

Copyright Notice:

The entire contents of this CD/DVD are copyright 2014 by ADV Plans, LLC. All Rights Reserved.

Reproduction or distribution of this disk, either free or for a fee is strictly prohibited. We actively monitor and remove listings on eBay thru Vero.

You are free to copy or use individual images in your own projects, magazines, brochures or other school projects.

Only the sellers listed here are authorized distributors of this collection:
www.theclassicarchives.com/authorizedsuppliers

Please view our other products at
www.theclassicarchives.com,
or our ebay stores:

[TheClassicArchives](#)
[ADVPlans](#)
[SuperShedPlans](#)

